

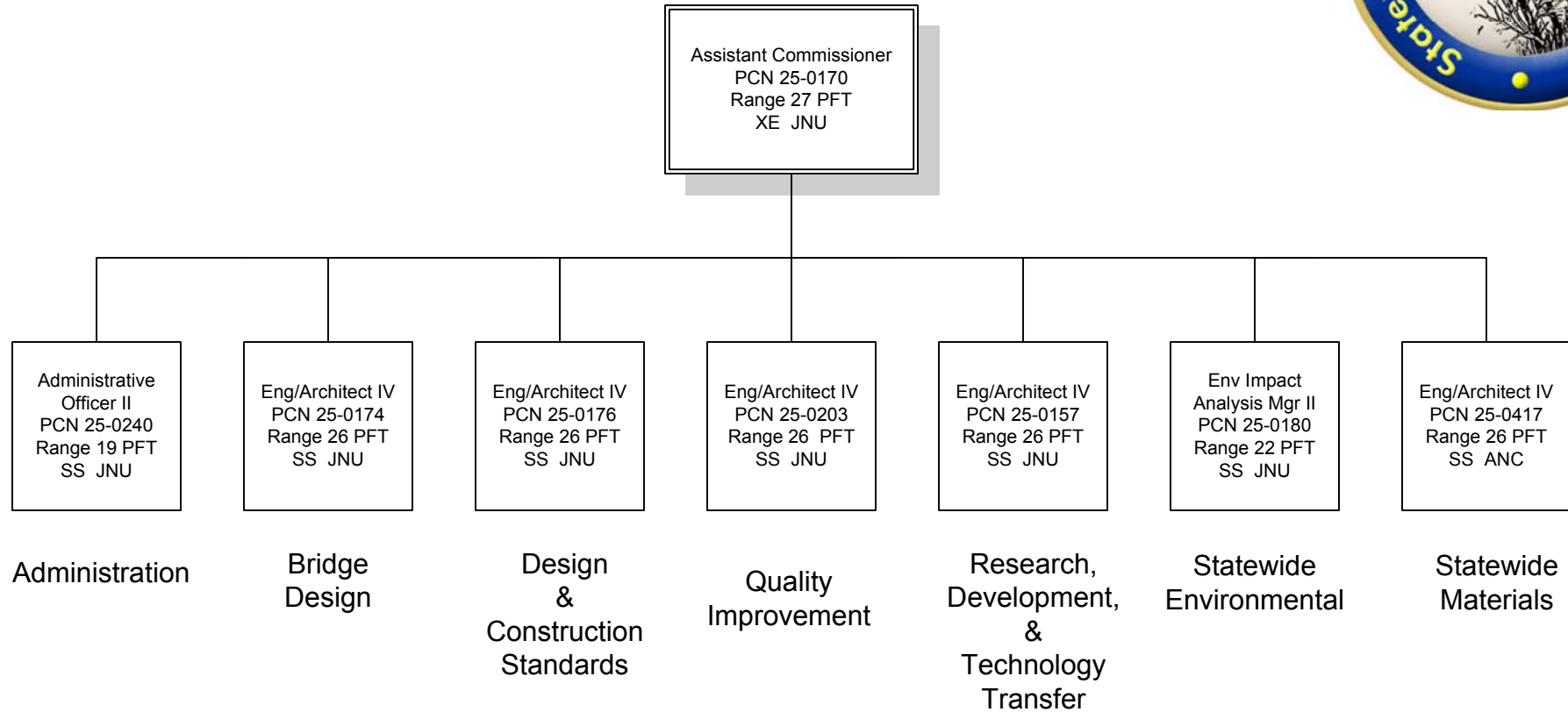

Chief Engineer's Office



Department of Transportation & Public Facilities
RDU: Design, Engineering and Construction
Component: Statewide Design & Engineering Services
FY2015 Governor's Budget
73 - PFT, 4 - PPT, 10 - NP



Administration

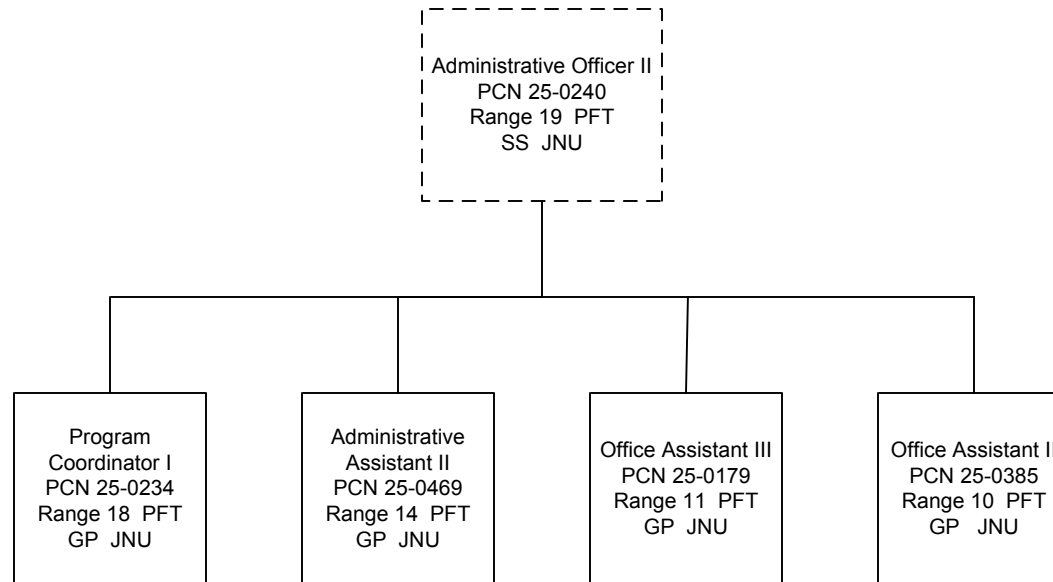

Bridge Design

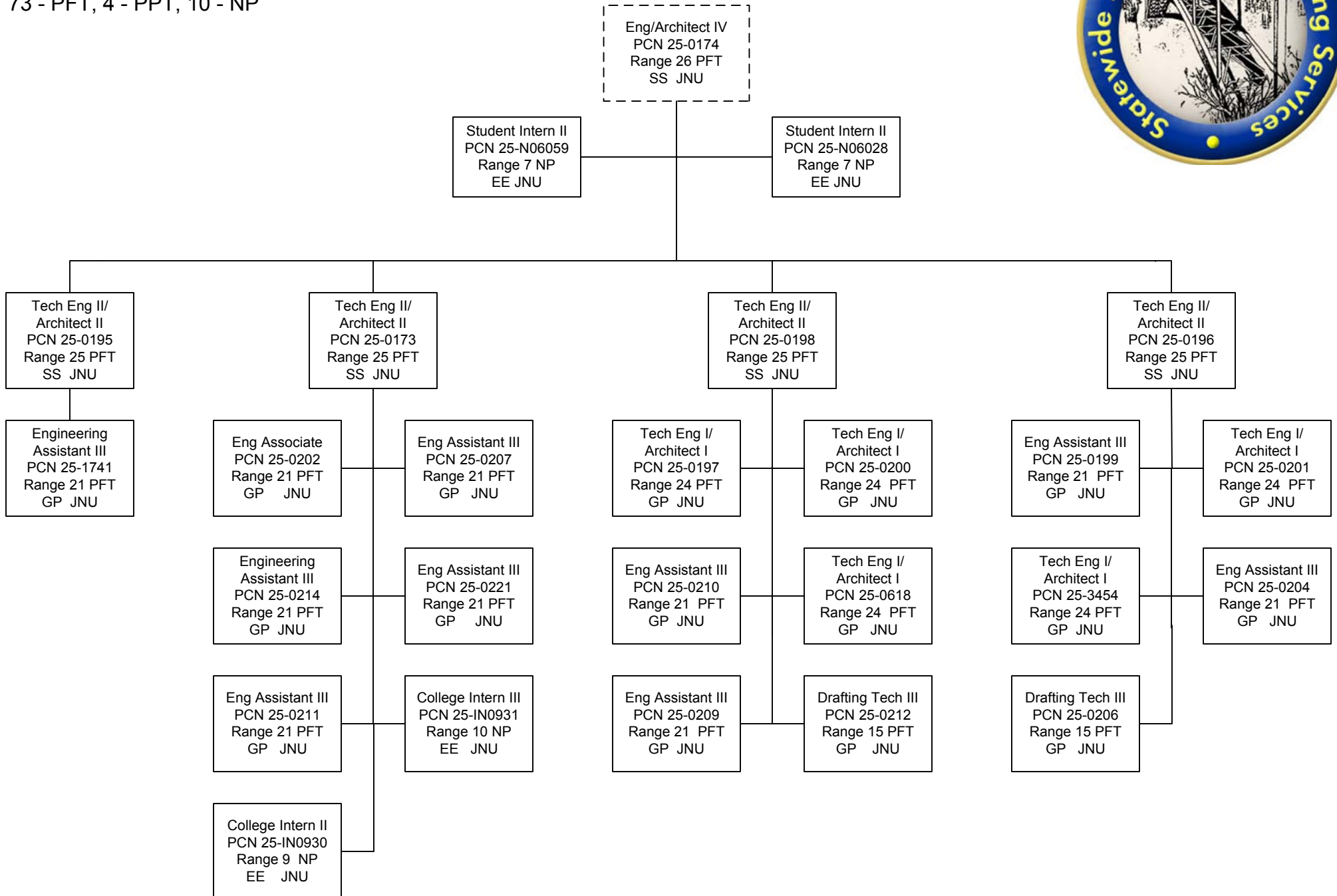

Design & Construction Standards

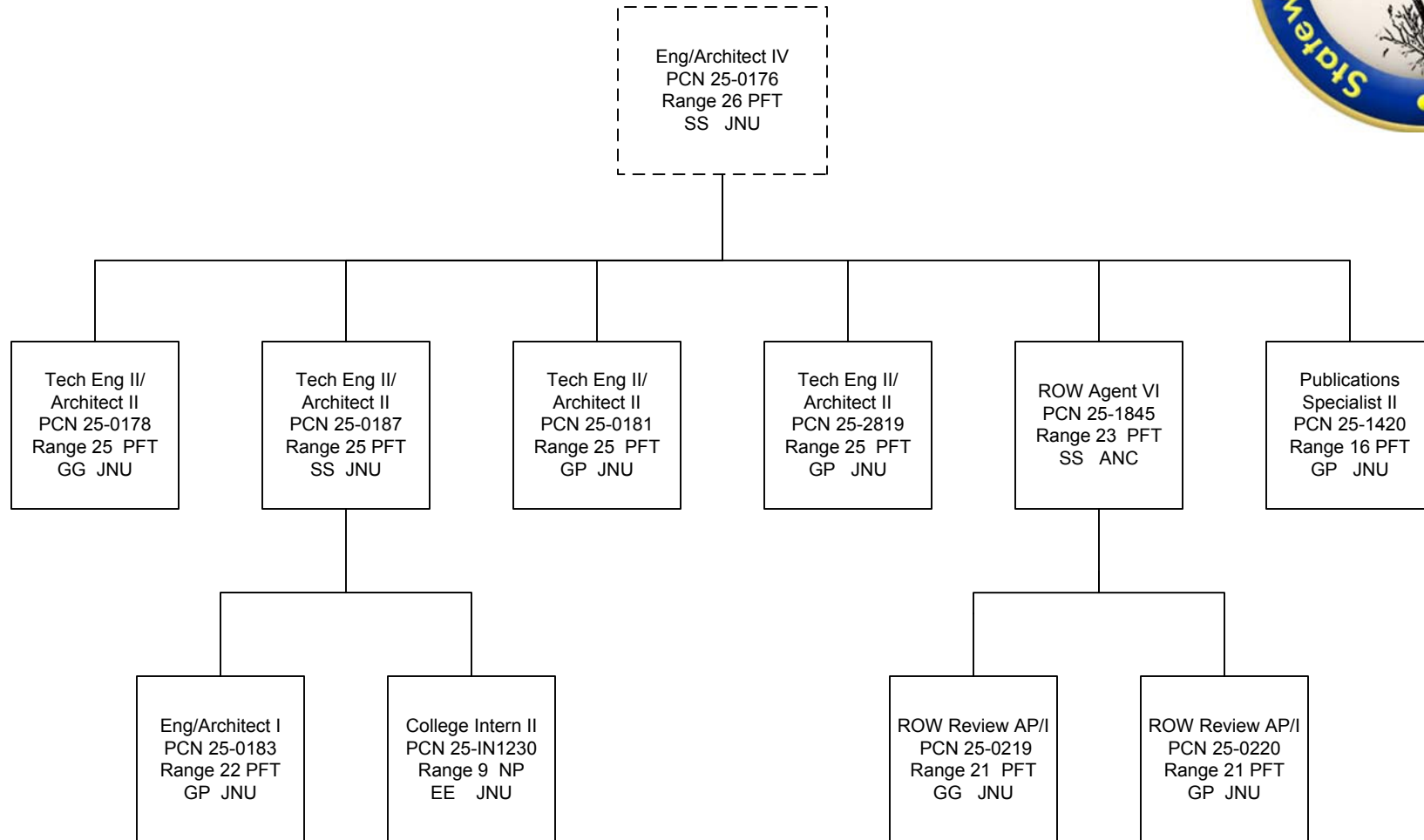

Department of Transportation & Public Facilities
RDU: Design, Engineering and Construction
Component: Statewide Design & Engineering Services
FY2015 Governor's Budget
73 - PFT, 4 - PPT, 10 - NP



Quality Improvement

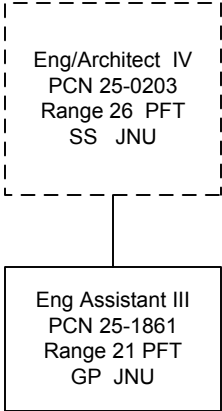



Research, Development, & Technology Transfer

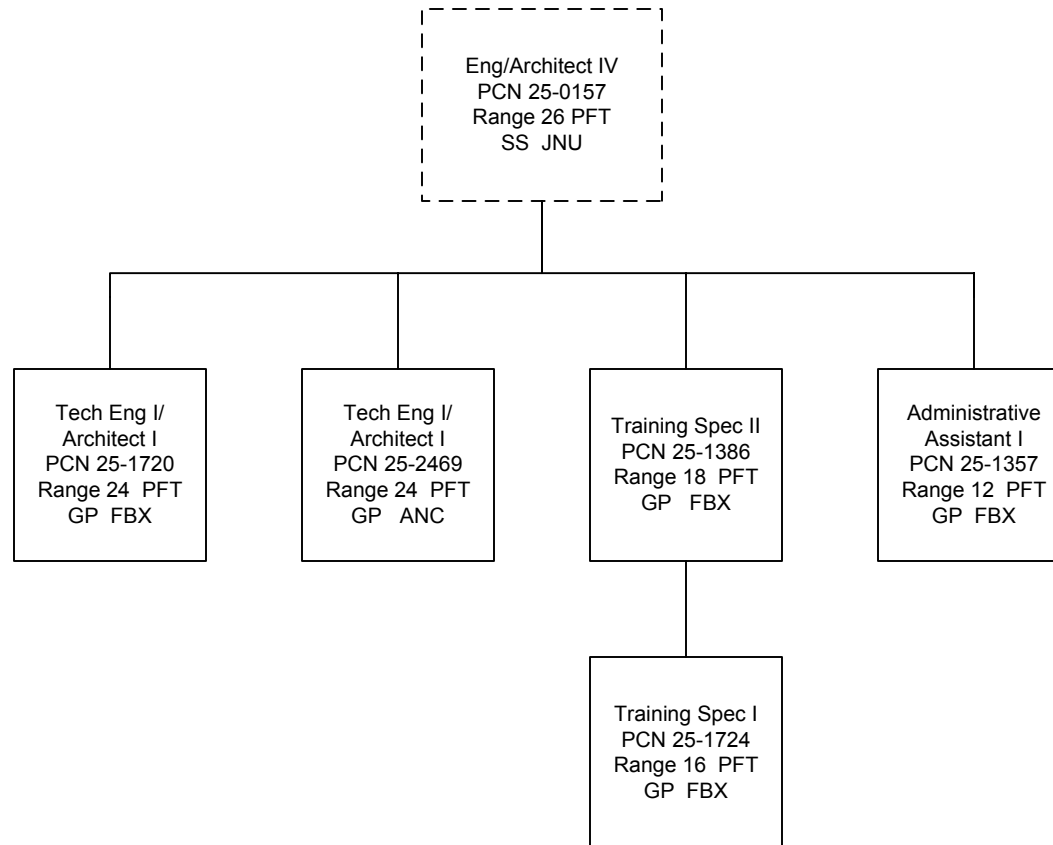



Statewide Environmental

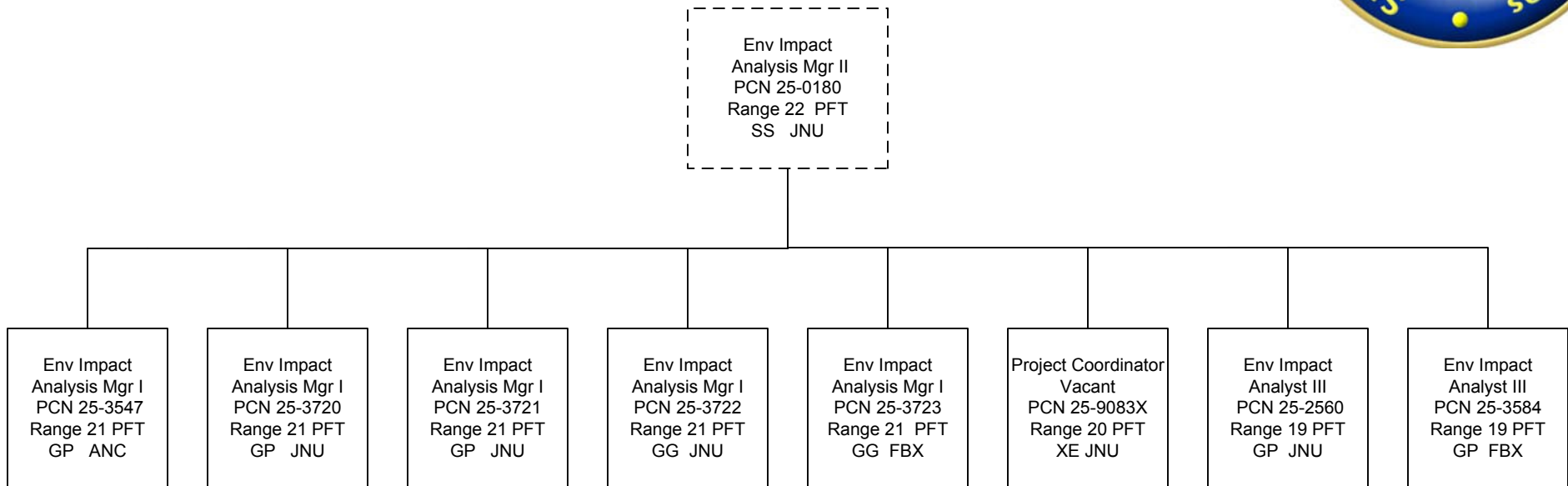



Statewide Materials

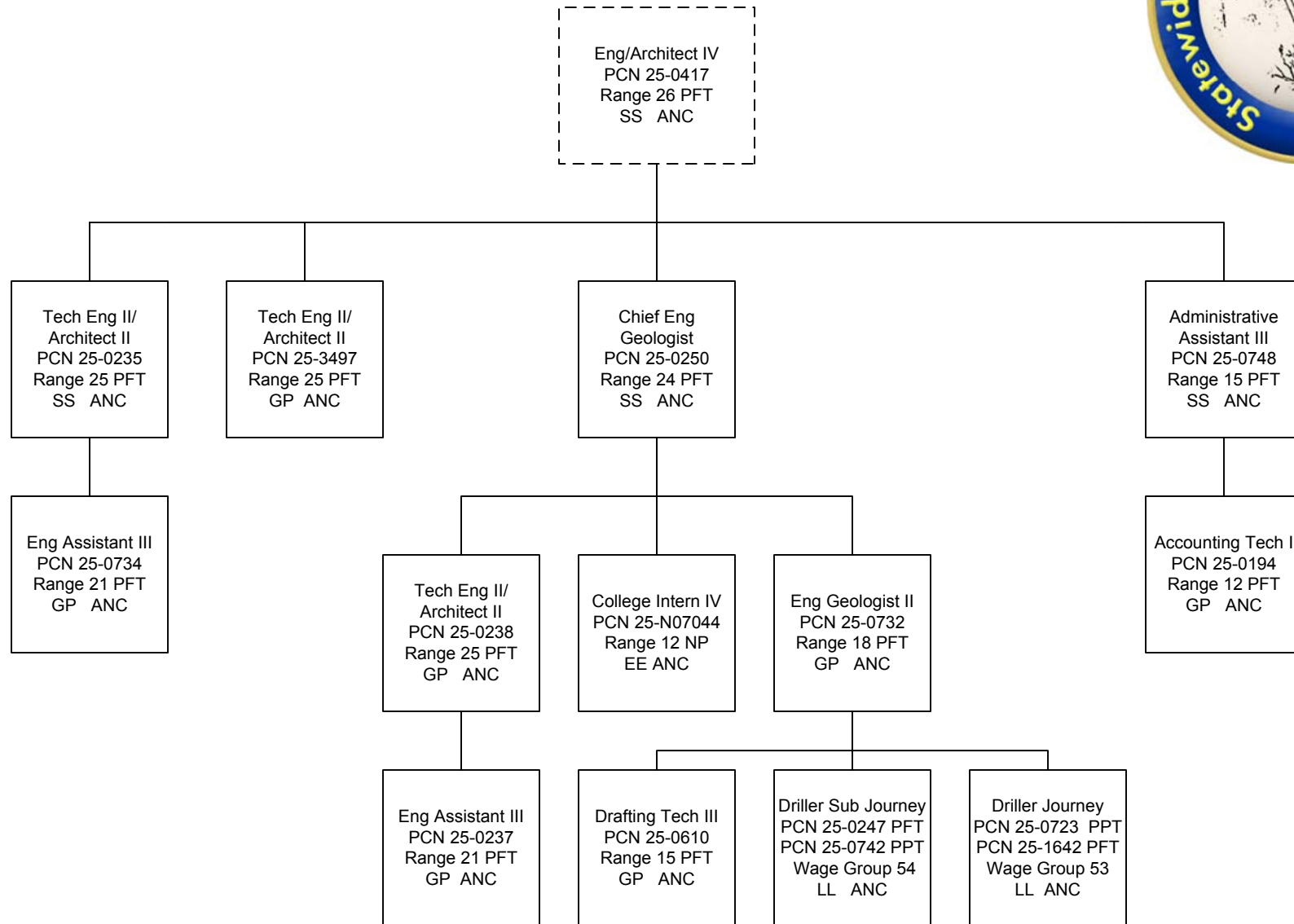



Special Projects

