

Department of Health & Social Services
 FY2019 Operating Budget
 Health Care Services
 Medical Assistance Administration
 Management
 PFT: 3 PPT: 0 NP: 0
 ANC: 2 JUN: 1

HEALTH CARE SERVICES MANAGEMENT

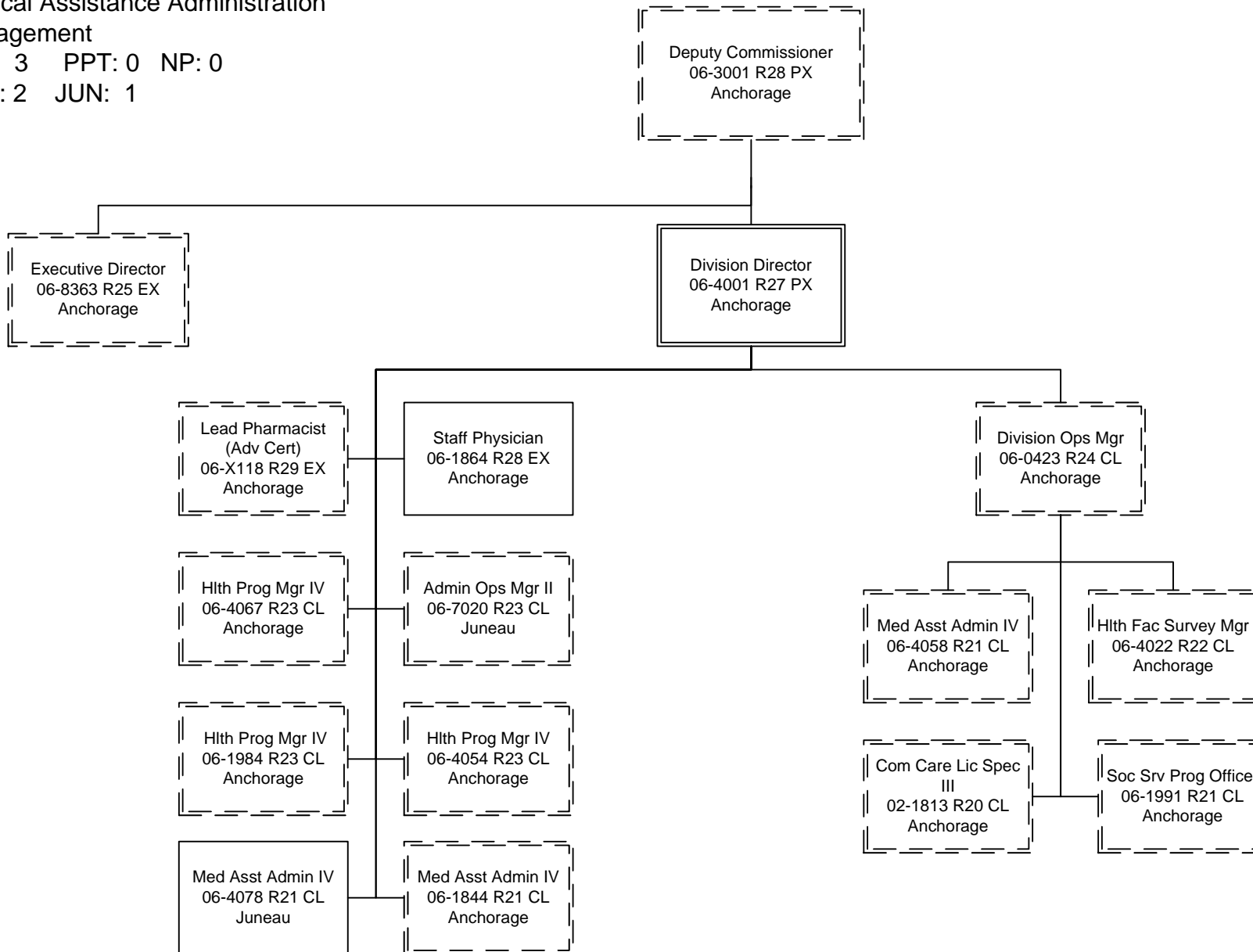

Department of Health & Social Services
FY2019 Operating Budget
Health Care Services
Medical Assistance Administration
PFT: 9 PPT: 0 NP: 0
ANC: 6 JUN: 3

ADMINISTRATIVE STAFF

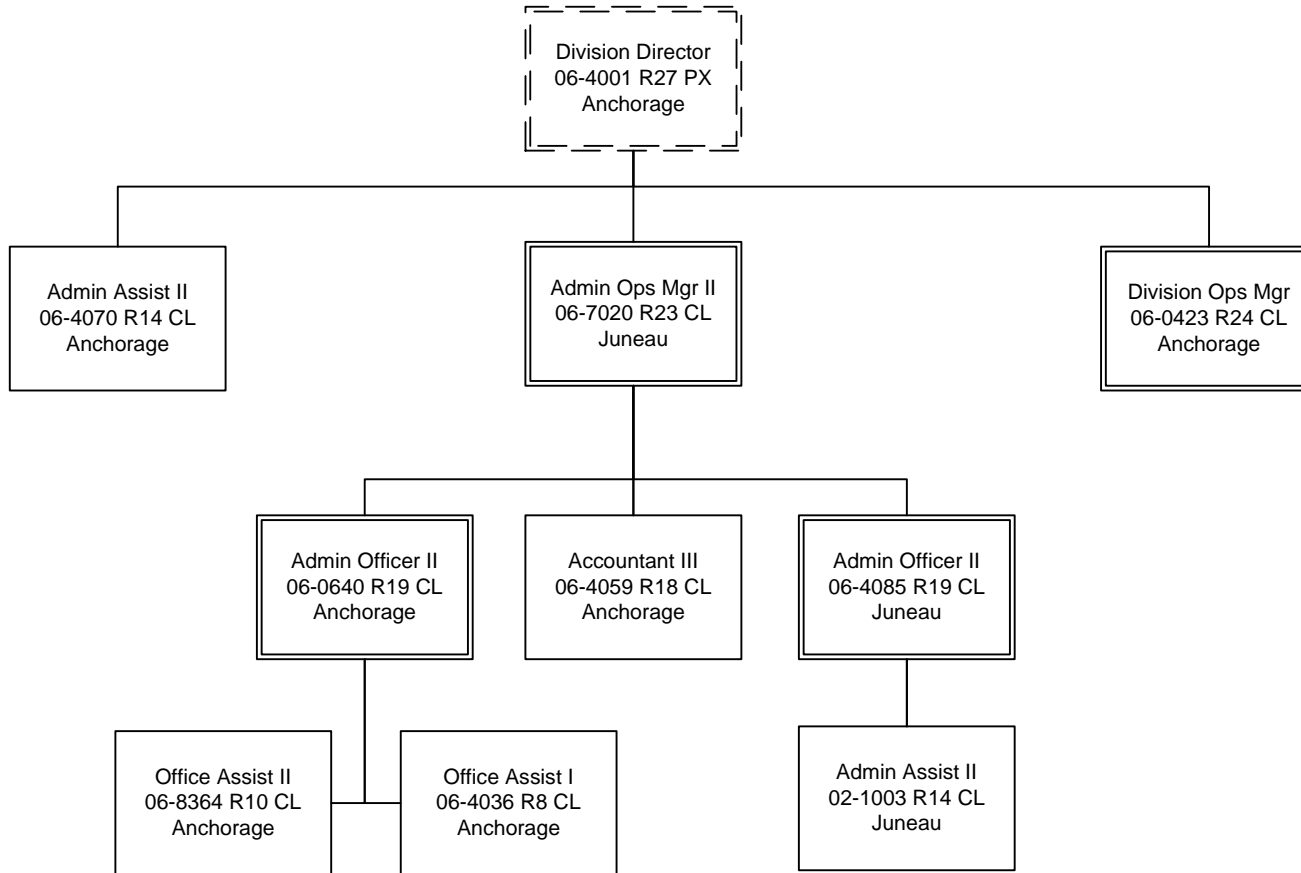

Department of Health & Social Services
FY2019 Operating Budget
Health Care Services
Medical Assistance Administration
PFT: 11 PPT: 0 NP: 0
ANC: 11 JUN: 0

ACCOUNTING & RECOVERY

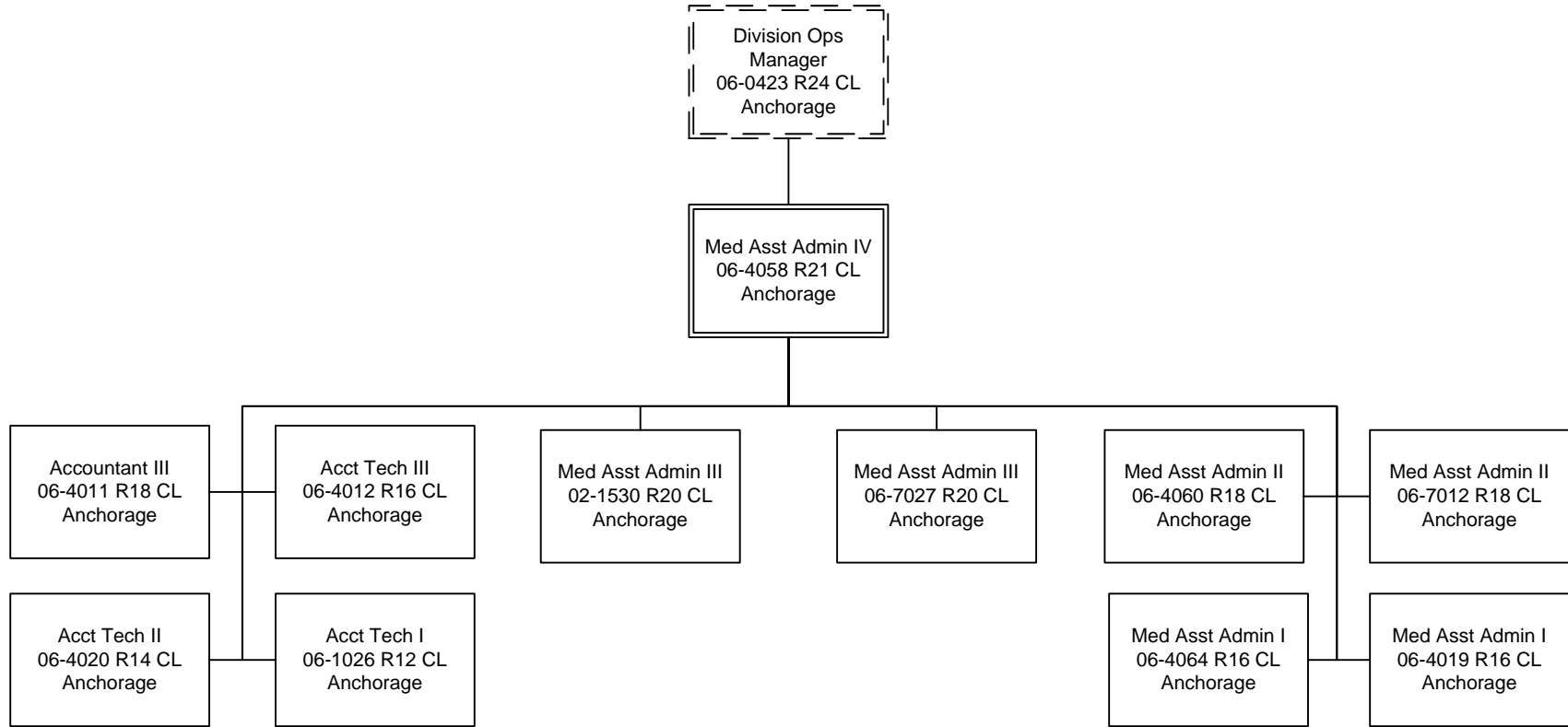

Department of Health & Social Services
FY2019 Operating Budget
Health Care Services
Medical Assistance Administration
PFT: 16 PPT: 0 NP: 0
ANC: 16 JUN: 0

MEDICAID MANAGEMENT INFORMATION SYSTEM & DECISION SUPPORT

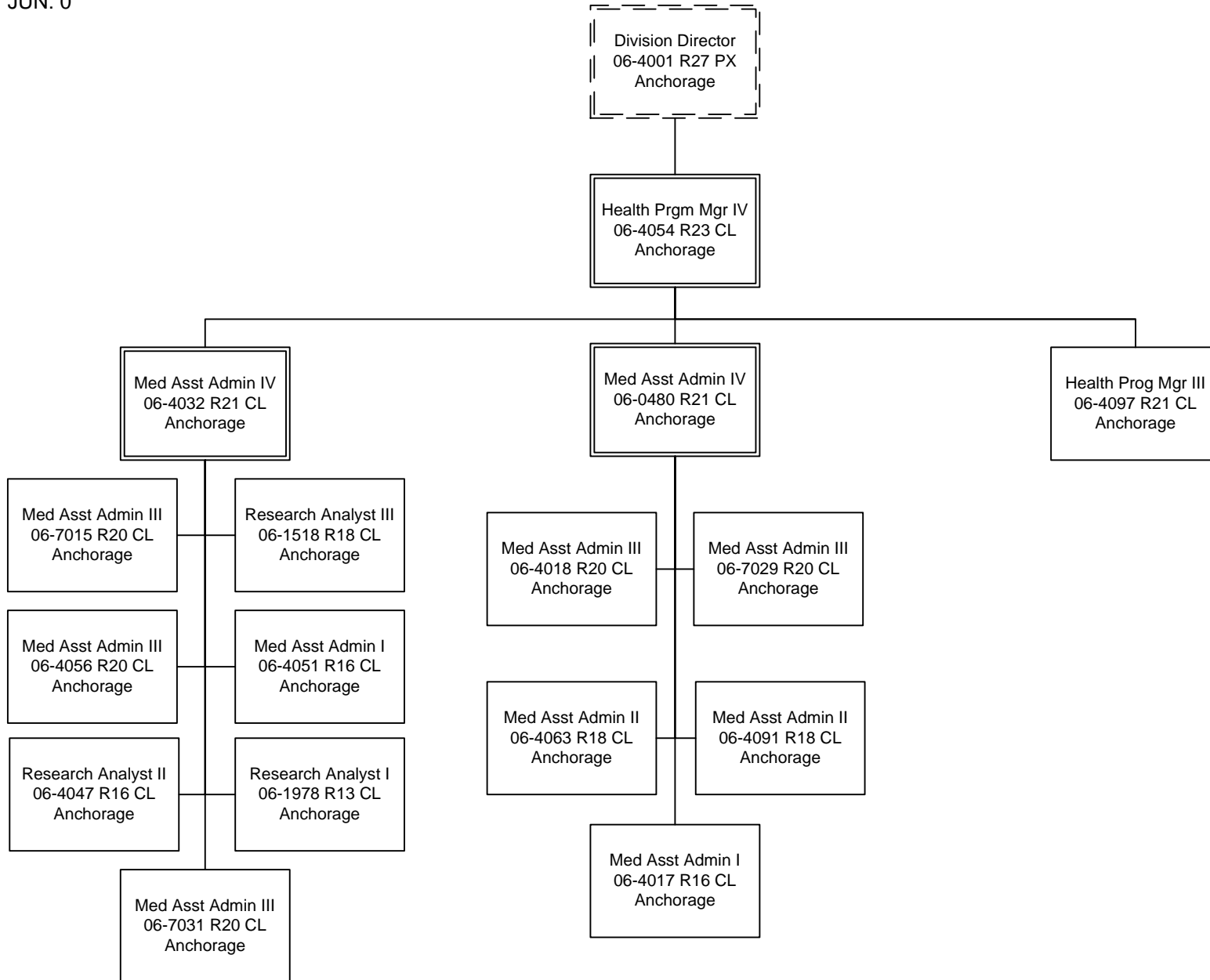

Department of Health & Social Services
FY2018 Operating Budget
Health Care Services
Medical Assistance Administration
PFT: 2 PPT: 0 NP: 0
ANC: 2 JUN: 0

HEALTH INFORMATION
TECHNOLOGY

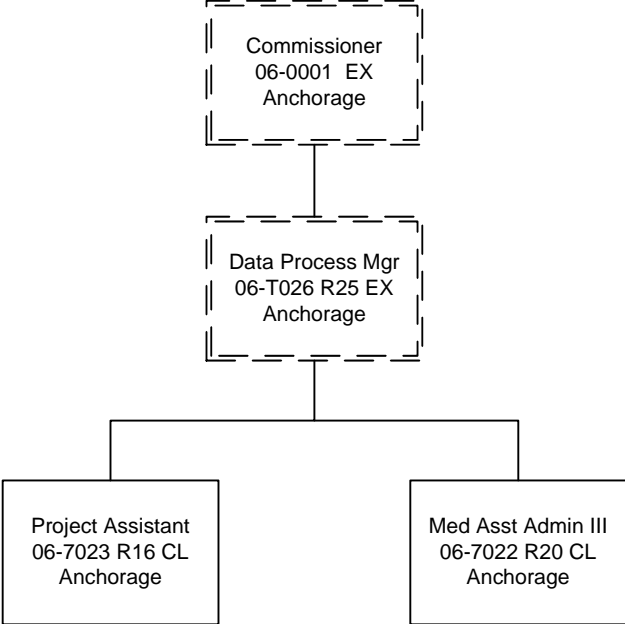

Department of Health & Social Services
FY2019 Operating Budget
Health Care Services
Medical Assistance Administration
PFT: 4 PPT: 0 NP: 0
ANC: 4 JUN: 0

PHARMACY & ANCILLARY

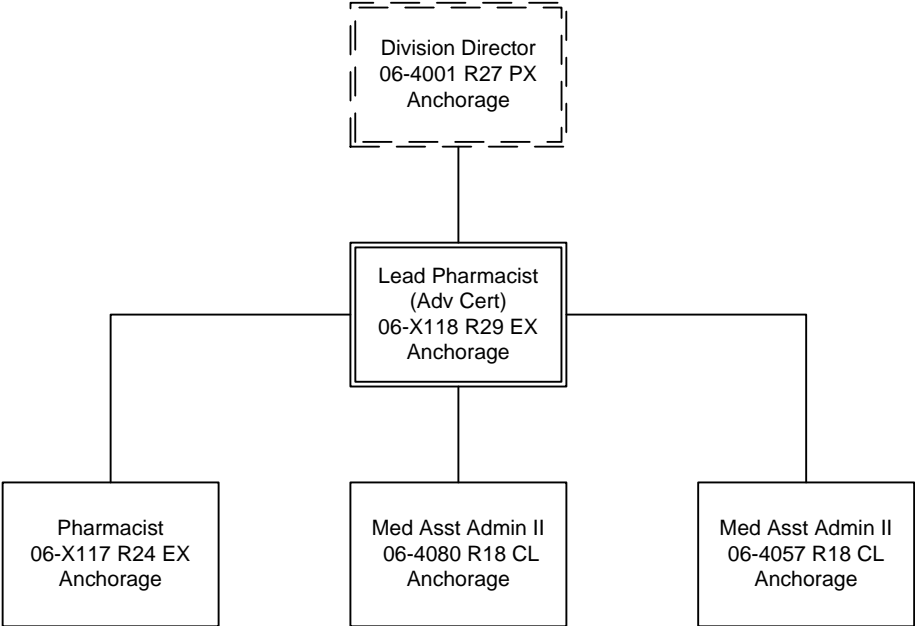

Department of Health & Social Services
FY2019 Operating Budget
Health Care Services
Medical Assistance Administration
PFT: 14 PPT: 0 NP: 2
ANC: 16 JUN: 0

OPERATIONS

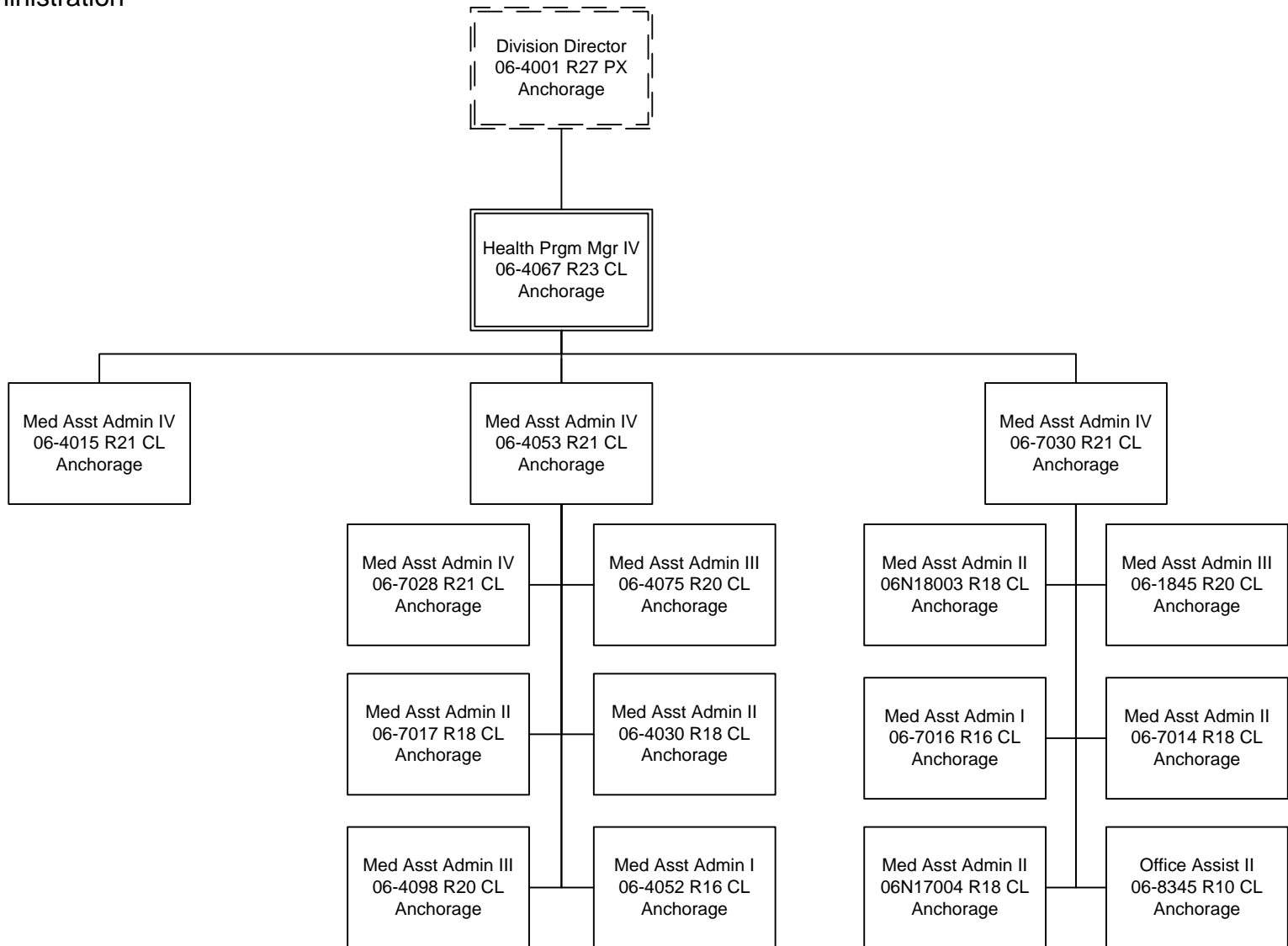

Department of Health & Social Services
FY2019 Operating Budget
Health Care Services
Medical Assistance Administration
PFT: 9 PPT: 0 NP: 1
ANC: 10 JUN: 0

QUALITY ASSURANCE

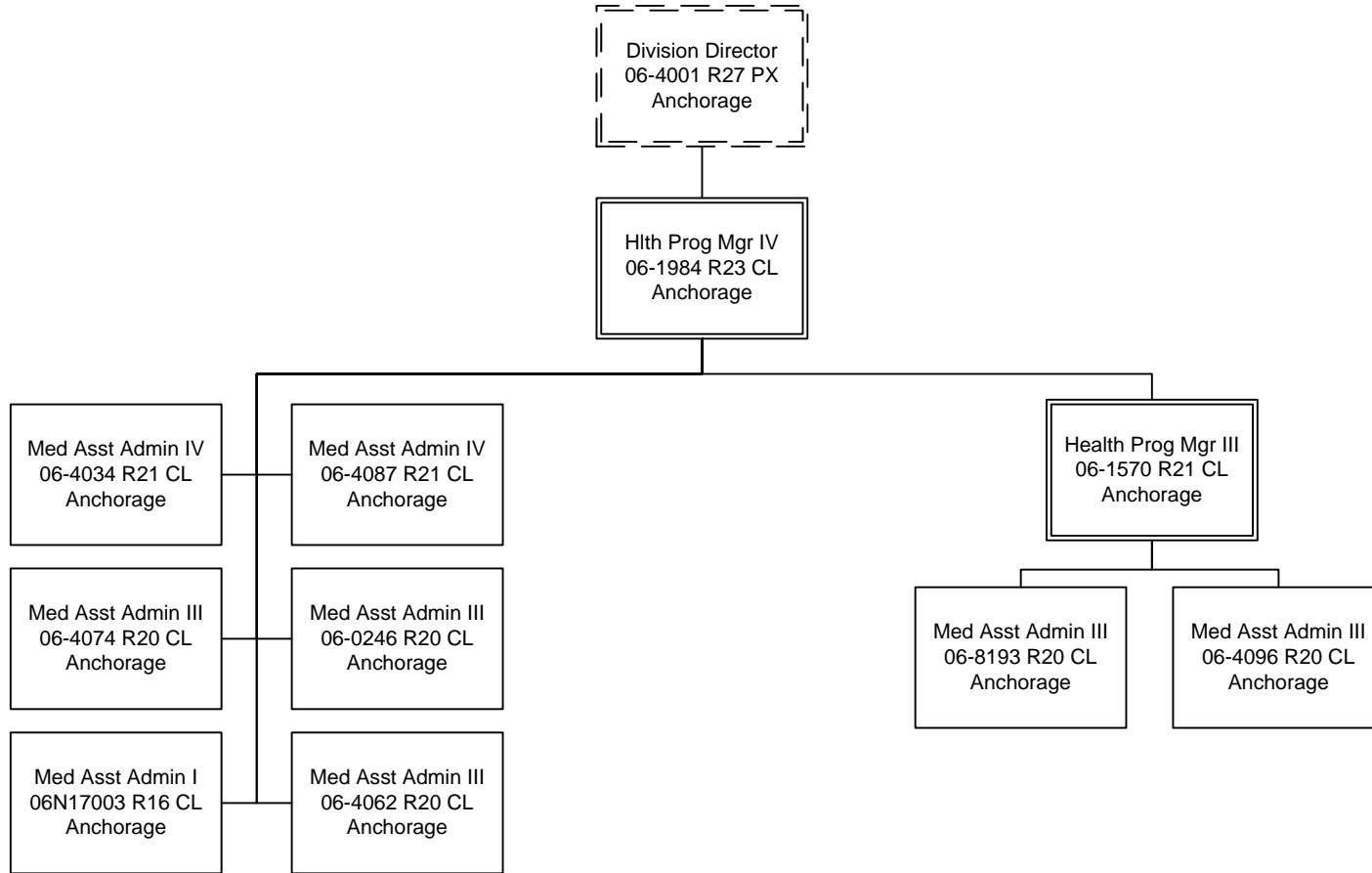

Department of Health & Social Services
FY2019 Operating Budget
Health Care Services
Medical Assistance Administration
PFT: 3 PPT: 0 NP: 1
ANC: 3 JUN: 1

PROGRAM REVIEW - MEDICAID

