

Department of Administration
 ALAS/APDA
 Public Defender Agency
 Administrative/Overview Section

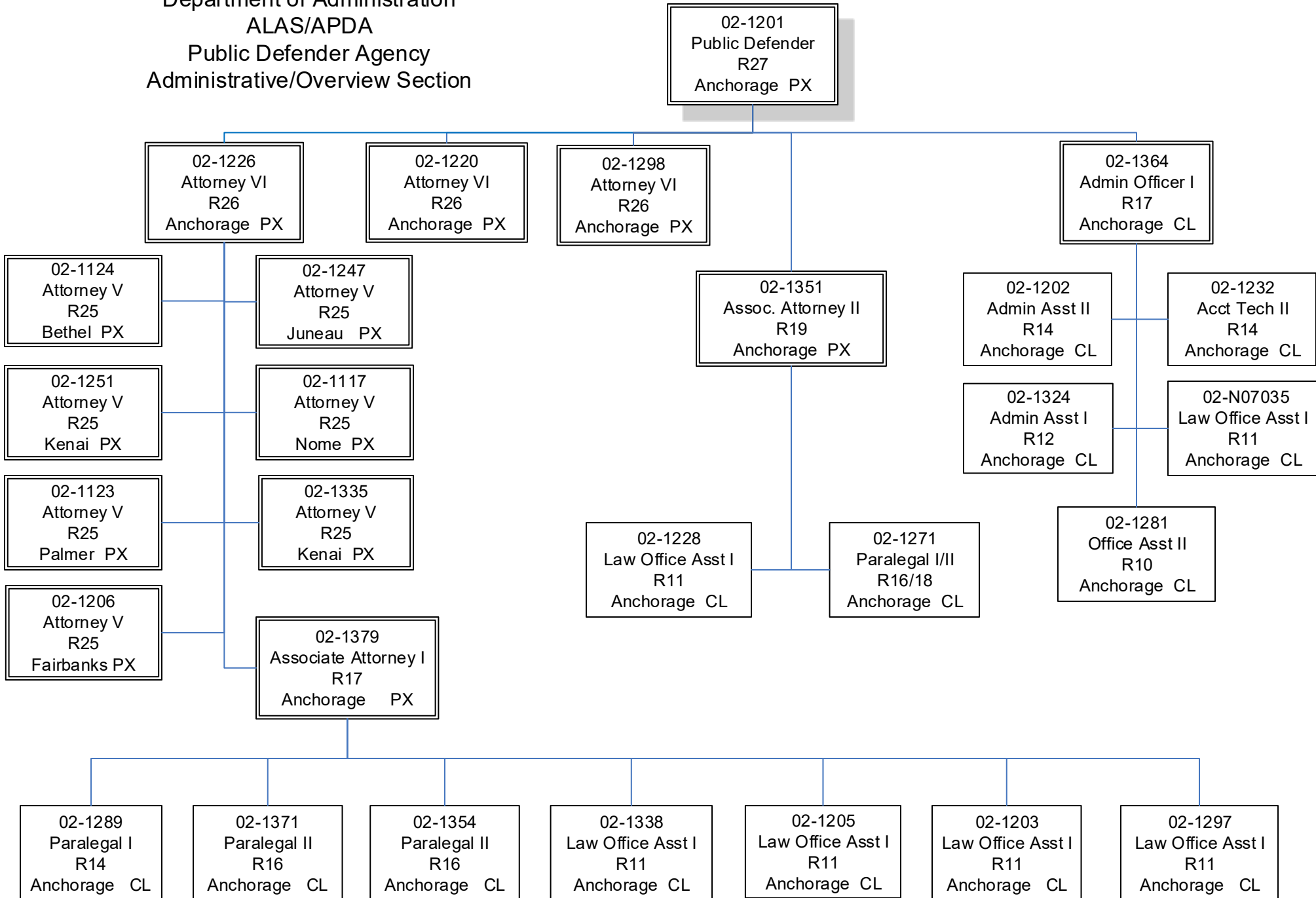

Department of Administration
ALAS/APDA
Public Defender Agency
Anchorage Criminal/Support Staff

02-1226
Attorney VI
R26
Anchorage PX

02-1274
Investigator III
R18
Anchorage CL

02-1222
Attorney V
R25
Anchorage PX

02-1212
Investigator III
R18
Anchorage CL

02-1362
Investigator III
R18
Anchorage CL

02-1213
Paralegal II
R16
Anchorage CL

02-1330
Investigator III
R18
Anchorage CL

02-1275
Investigator III
R18
Anchorage CL

02-1347
Paralegal II
R16
Anchorage CL

02-1367
Paralegal II
R16
Anchorage CL

02-1352
Law Off Asst I
R11
Anchorage CL

02-1227
Law Off Asst I
R11
Anchorage CL

02-#085
Paralegal I-II
R14-16
Anchorage CL

02-#086
Paralegal I-II
R14-16
Anchorage CL

02-1129
Law Off Asst I
R11
Anchorage CL

02-1321
Law Office Asst I
R11
Anchorage CL

02-#087
Paralegal I-II
R14-16
Anchorage CL

02-#084
Paralegal I-II
R14-16
Anchorage CL

02-1214
Law Off Asst I
R11
Anchorage CL

Department of Administration
ALAS/APDA
Public Defender Agency
Anchorage Criminal Section

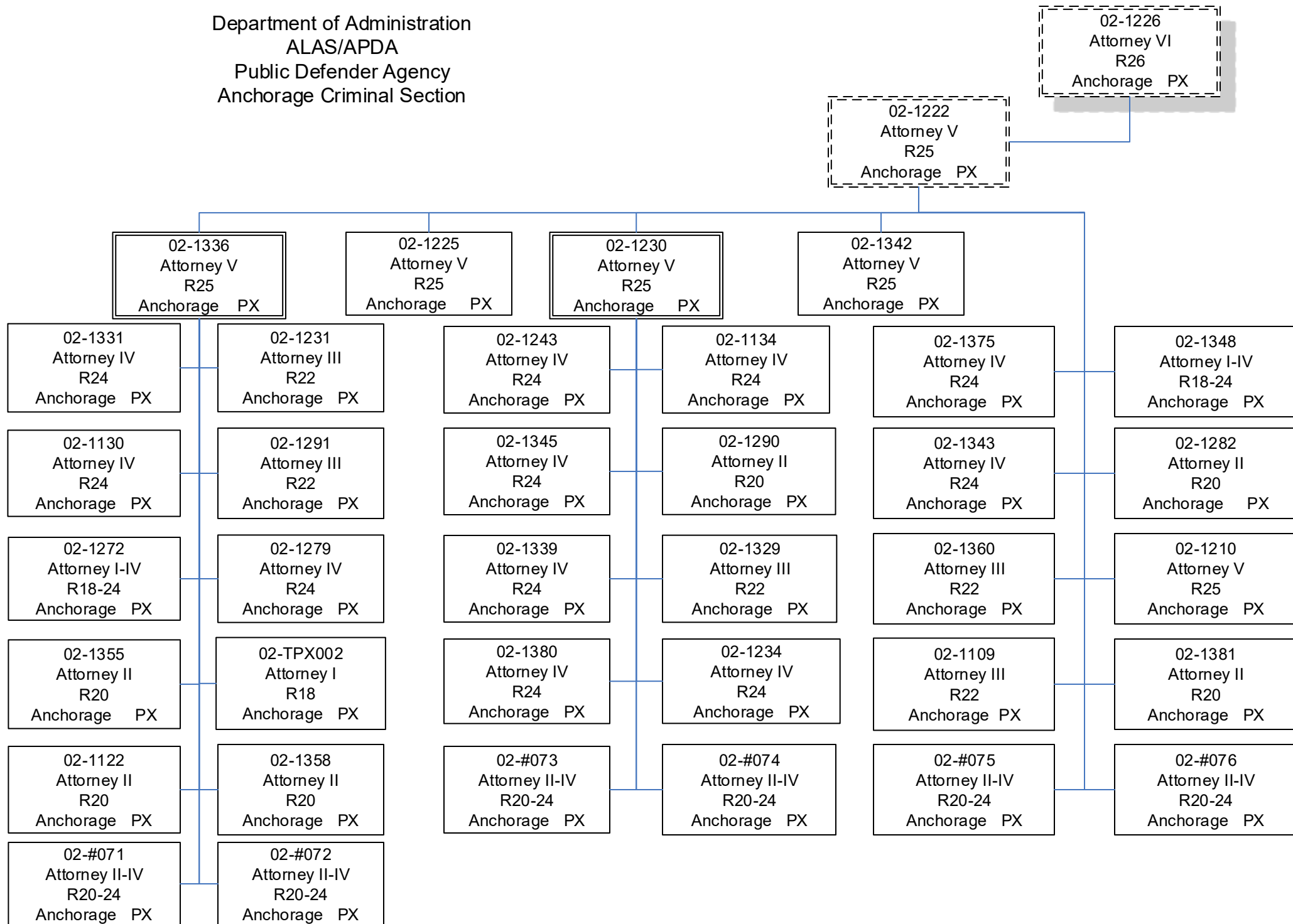

Department of Administration
ALAS/APDA
Public Defender Agency
Appeals & PCRS

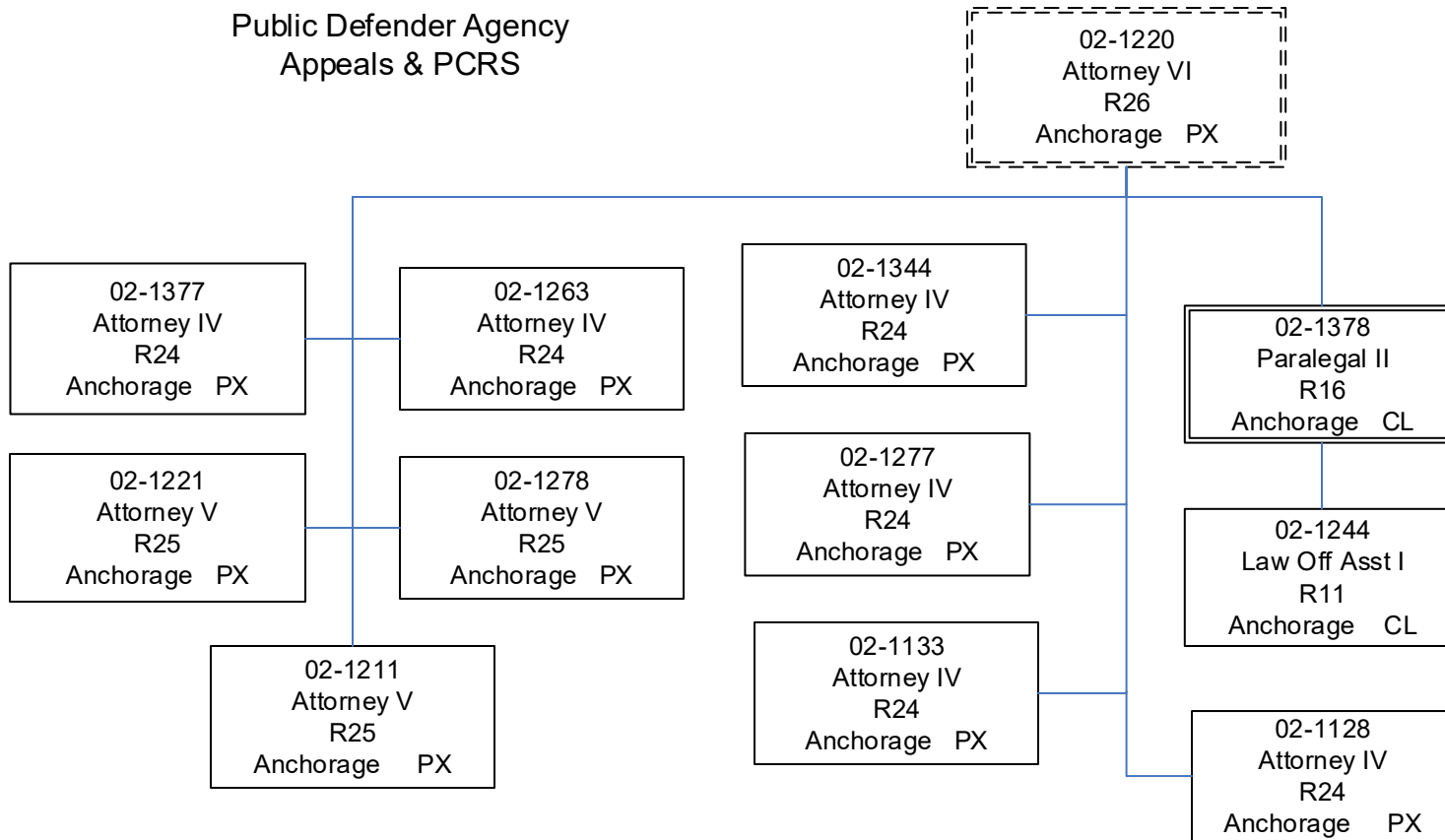

Department of Administration
 ALAS/APDA
 Public Defender Agency
 Outer-Offices (Bethel & Dillingham)

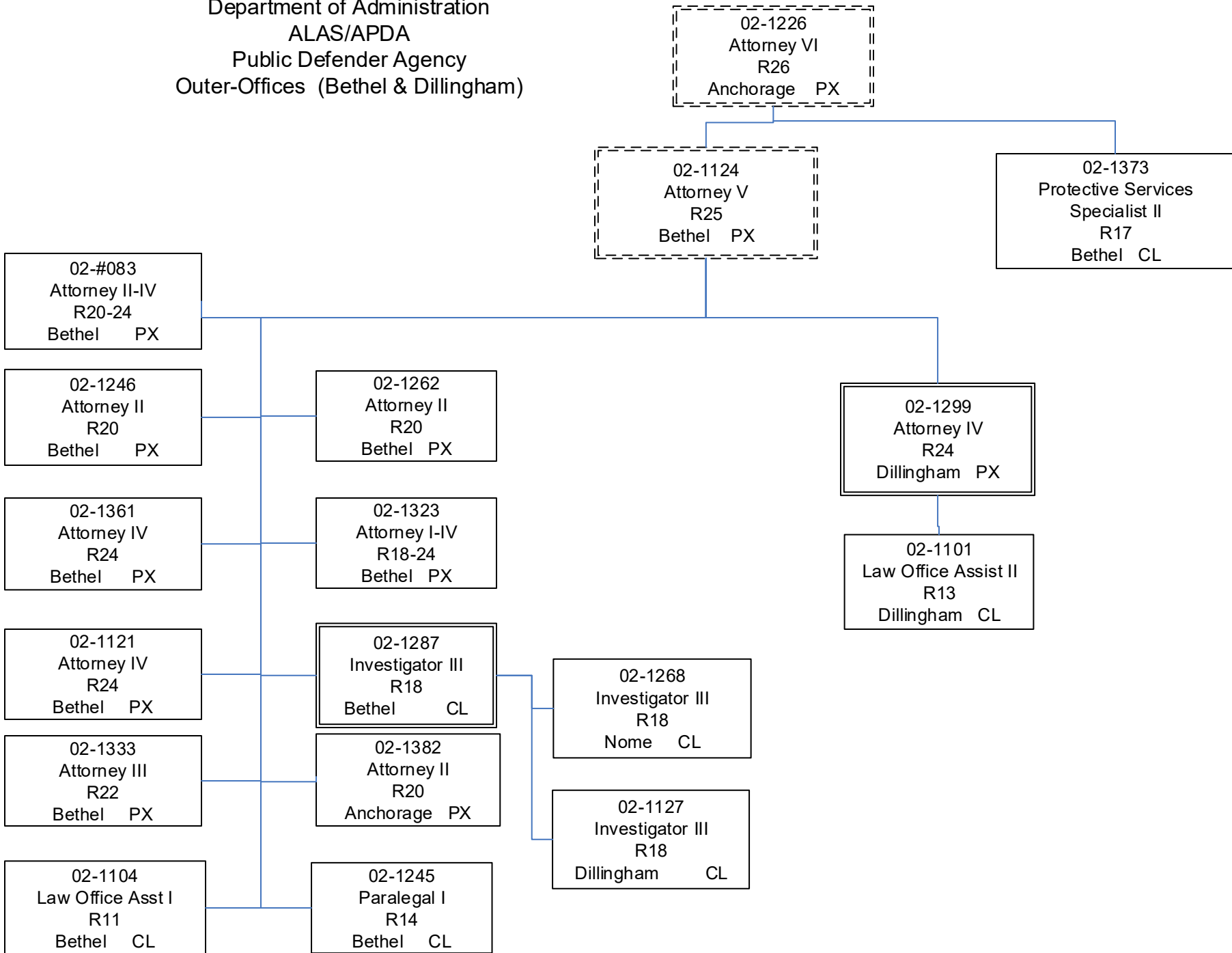

Department of Administration
ALAS/APDA
Public Defender Agency
Civil Section

02-1298
Attorney VI
R26
Anchorage PX

02-1334
Attorney IV
R24
Anchorage PX

02-1236
Attorney V
R25
Anchorage PX

02-1249
Attorney IV
R24
Anchorage PX

02-1374
Assoc. Attorney I
R17
Anchorage PX

02-1365
Paralegal II
R16
Anchorage CL

02-1280
Attorney IV
R24
Anchorage PX

02-1264
Attorney IV
R24
Anchorage PX

02-1224
Attorney IV
R24
Anchorage PX

02-1250
Paralegal II
R16
Anchorage CL

02-1327
Attorney IV
R24
Anchorage PX

02-1326
Attorney III
R22
Anchorage PX

02-1357
Law Off Asst I
R11
Anchorage CL

02-1346
Attorney IV
R24
Anchorage PX

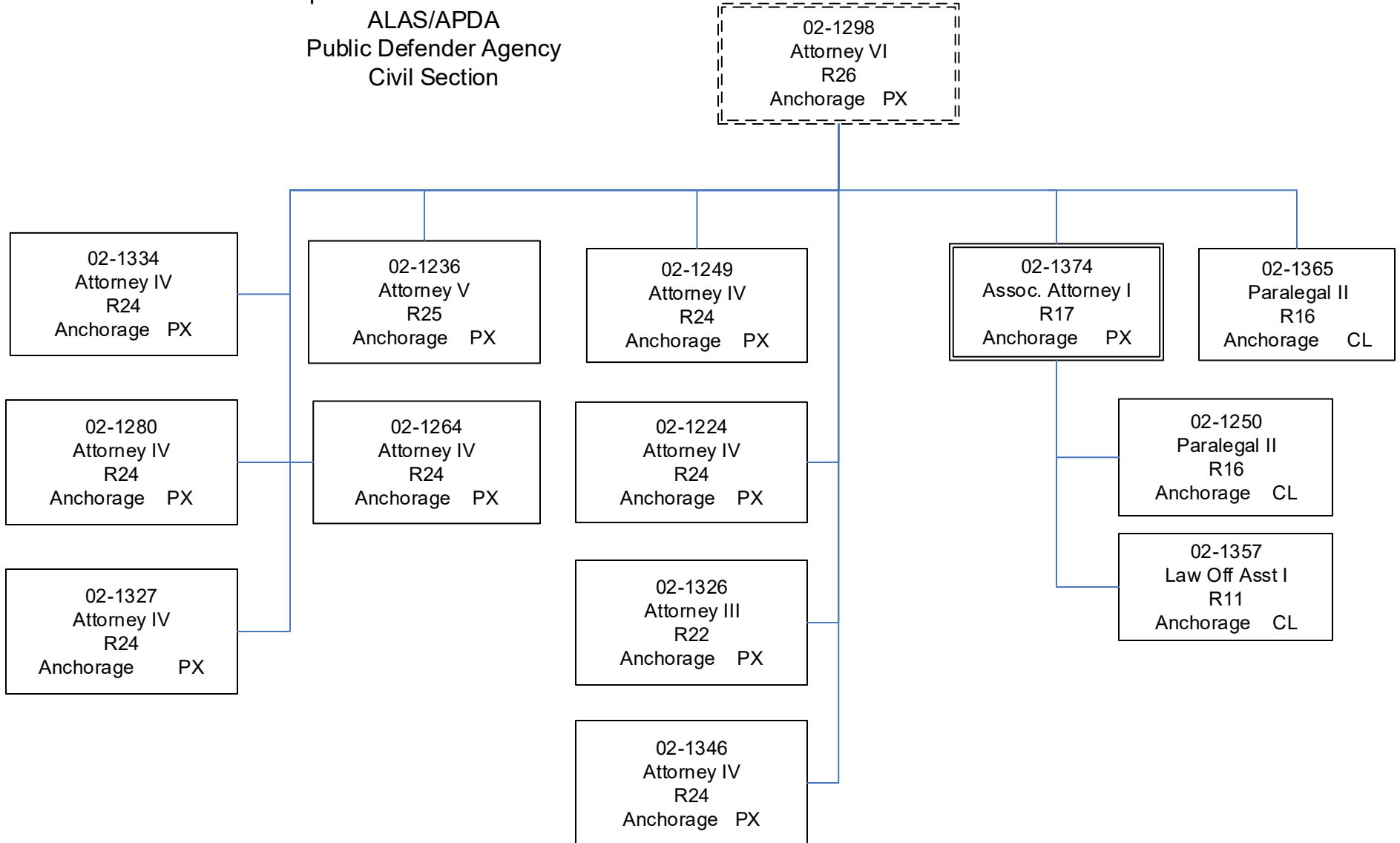

Department of Administration
 ALAS/APDA
 Public Defender Agency
 Outer-Offices (Fairbanks & Barrow)

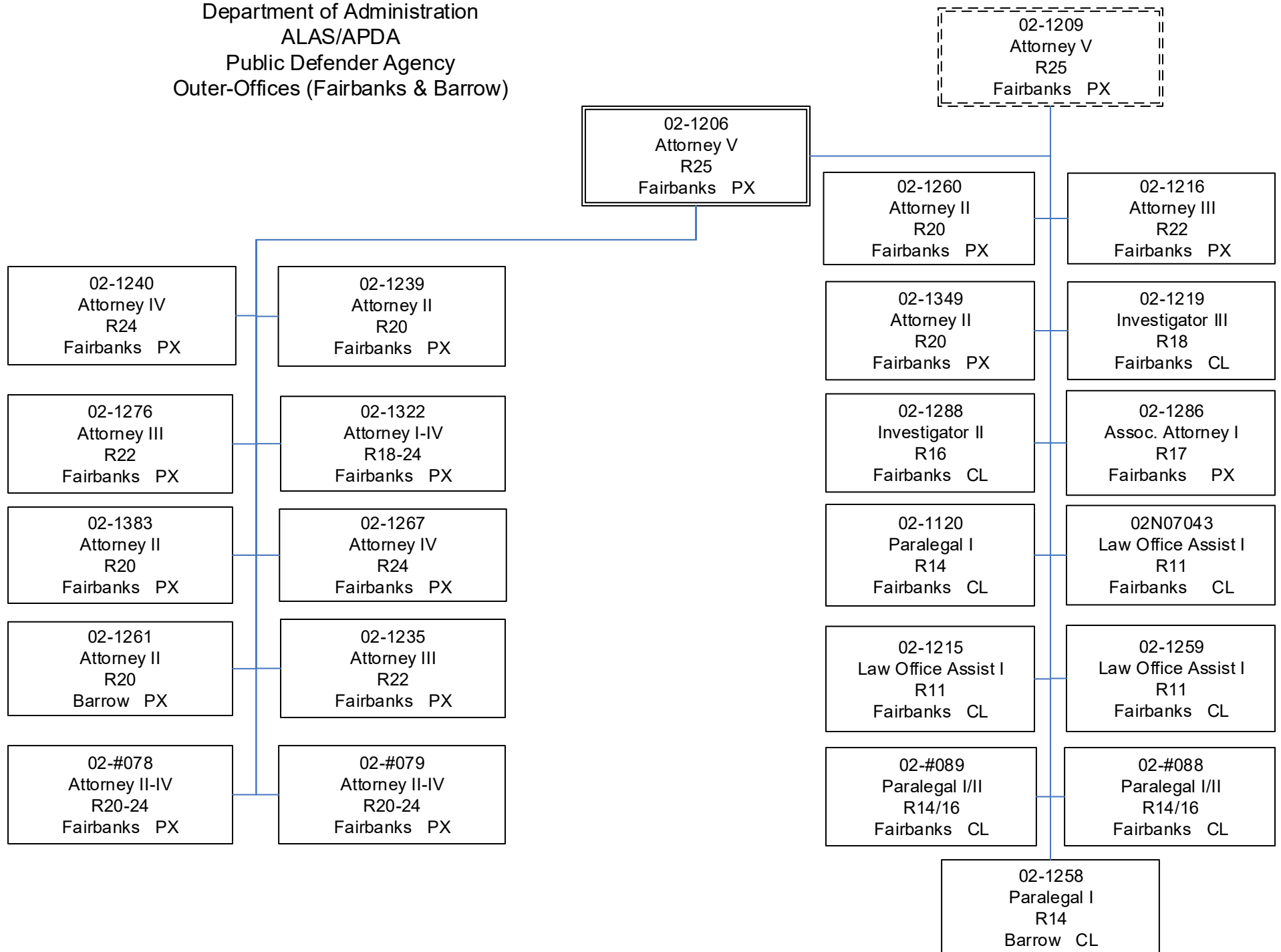

Department of Administration
 ALAS/APDA
 Public Defender Agency
 Outer-Offices (Juneau, Ketchikan & Sitka)

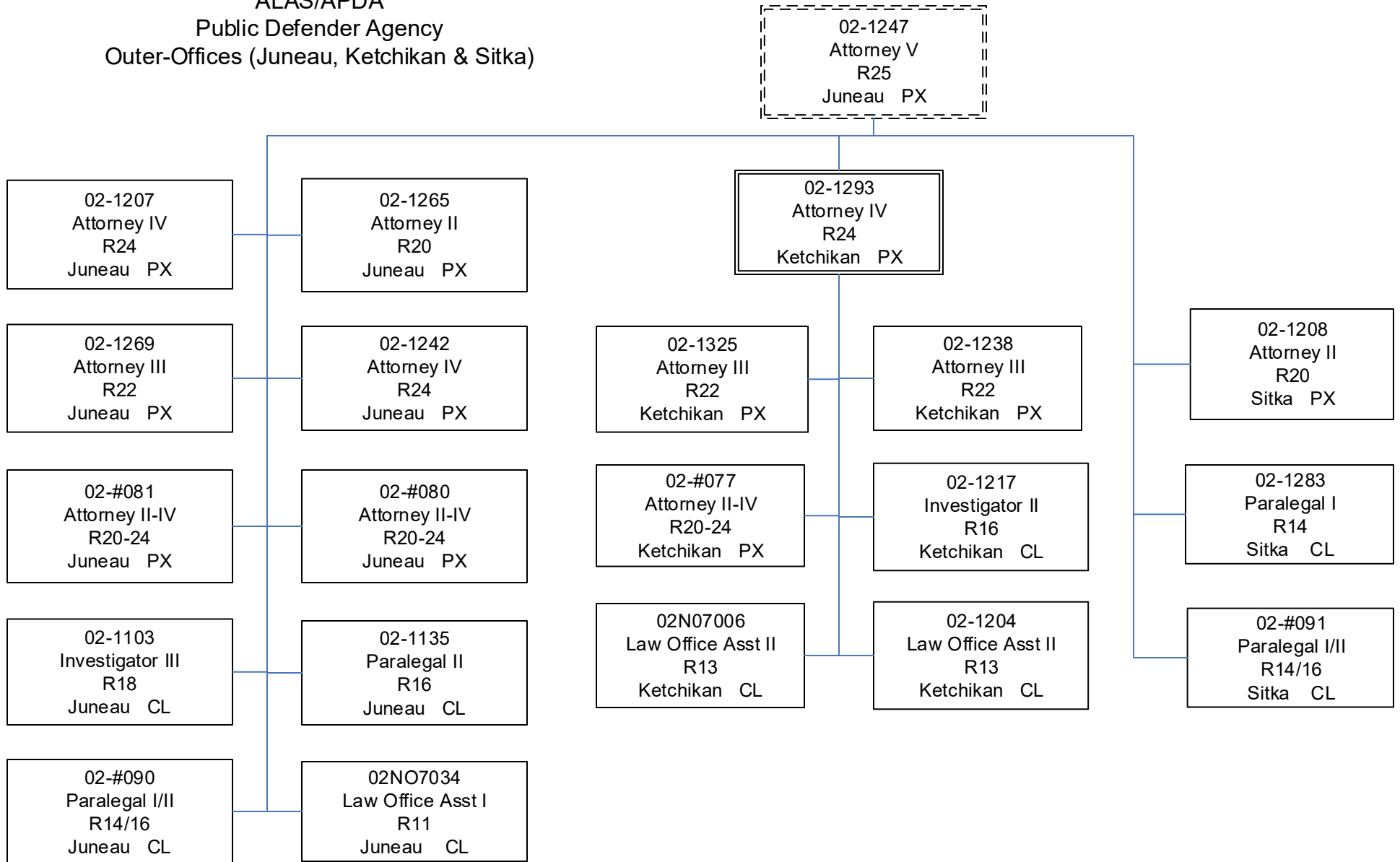

Department of Administration
ALAS/APDA
Public Defender Agency
Outer-Offices (Kenai & Kodiak)

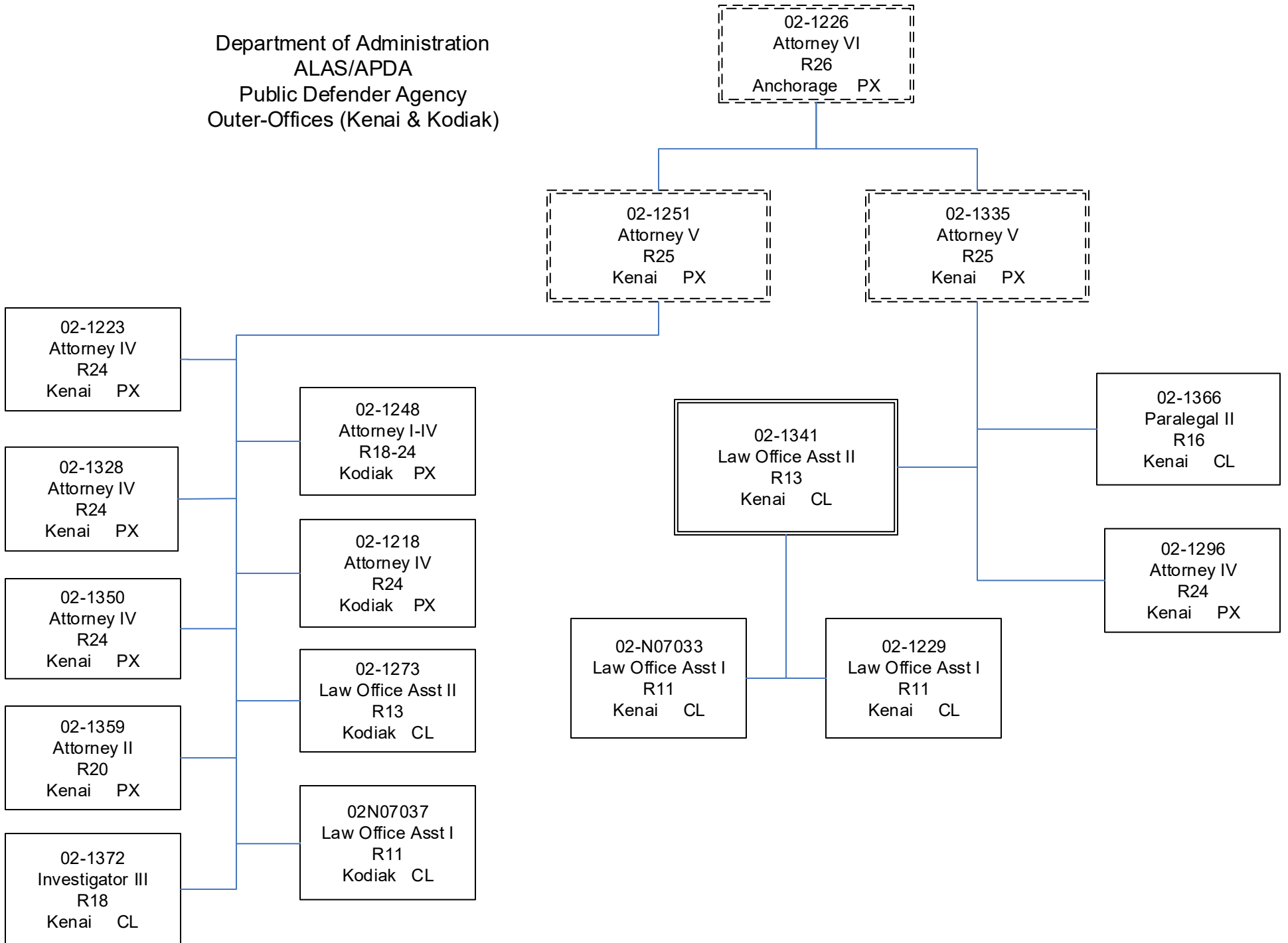

Department of Administration
ALAS/APDA
Public Defender Agency
Outer-Offices (Nome & Kotzebue)

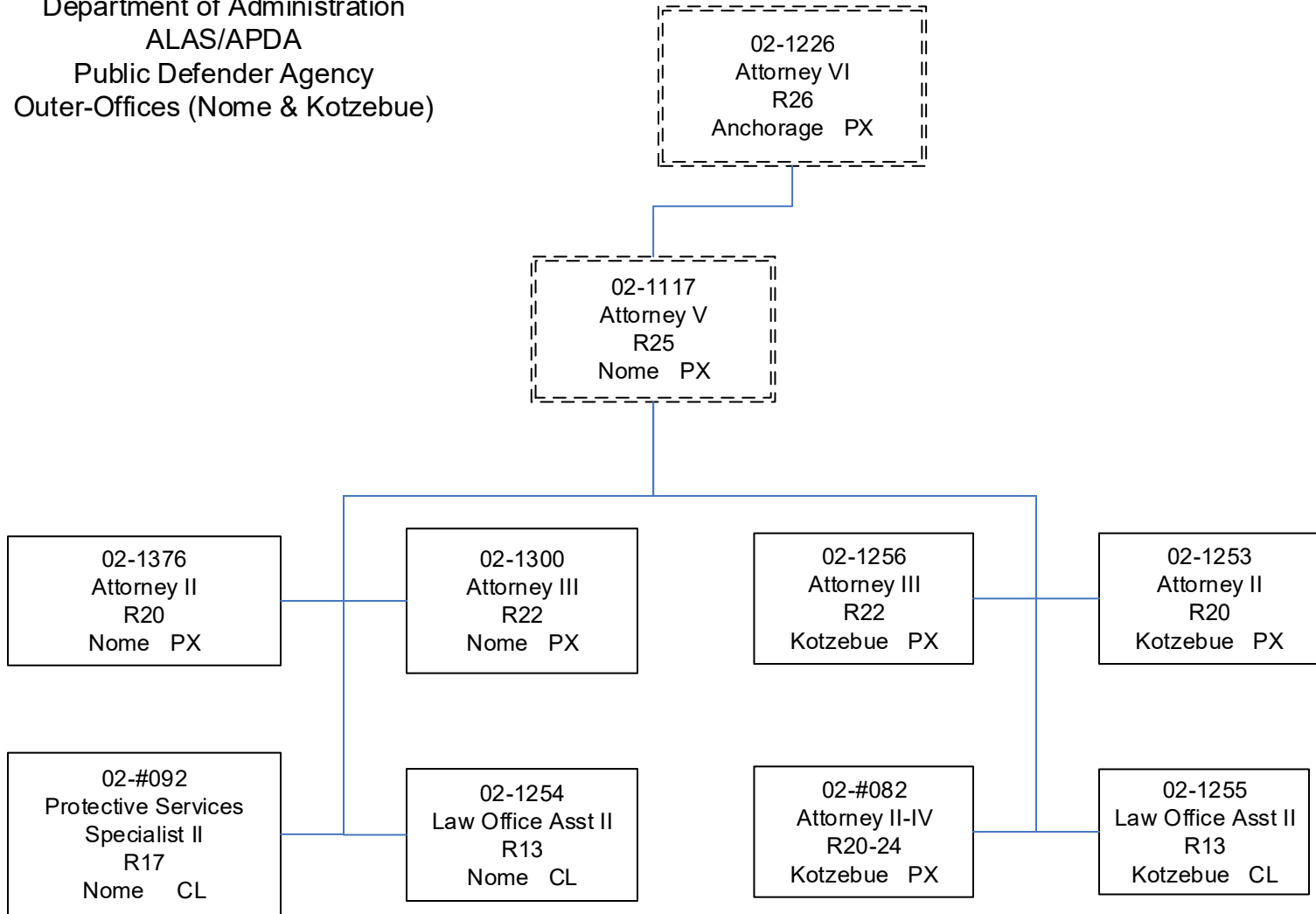

Department of Administration
ALAS/APDA
Public Defender Agency
Outer-Offices (Palmer)

02-1123
Attorney V
R25
Palmer PX

02-1118
Attorney IV
R24
Palmer PX

02-1270
Attorney IV
R24
Palmer PX

02-1106
Attorney I-IV
R18-24
Palmer PX

02-1363
Attorney I-IV
R18-24
Palmer PX

02-1332
Attorney IV
R24
Palmer PX

02-1292
Attorney II
R20
Palmer PX

02-1266
Attorney III
R22
Palmer PX

02-1284
Attorney IV
R24
Palmer PX

02-1320
Law Office Asst II
R13
Palmer CL

02-1102
Law Office Asst I
R11
Palmer CL

02-N07039
Law Office Asst I
R11
Palmer CL

02-1108
Investigator III
R18
Palmer CL

02-1119
Investigator III
R18
Palmer CL

02-1305
Paralegal II
R16
Palmer CL

02-1370
Paralegal II
R16
Palmer CL