

Department of Health & Social Services  
 FY2019 Operating Budget  
 Health Care Services  
 Medical Assistance Administration  
 Management  
 PFT: 3 PPT: 0 NP: 0  
 ANC: 2 JUN: 1

## HEALTH CARE SERVICES MANAGEMENT

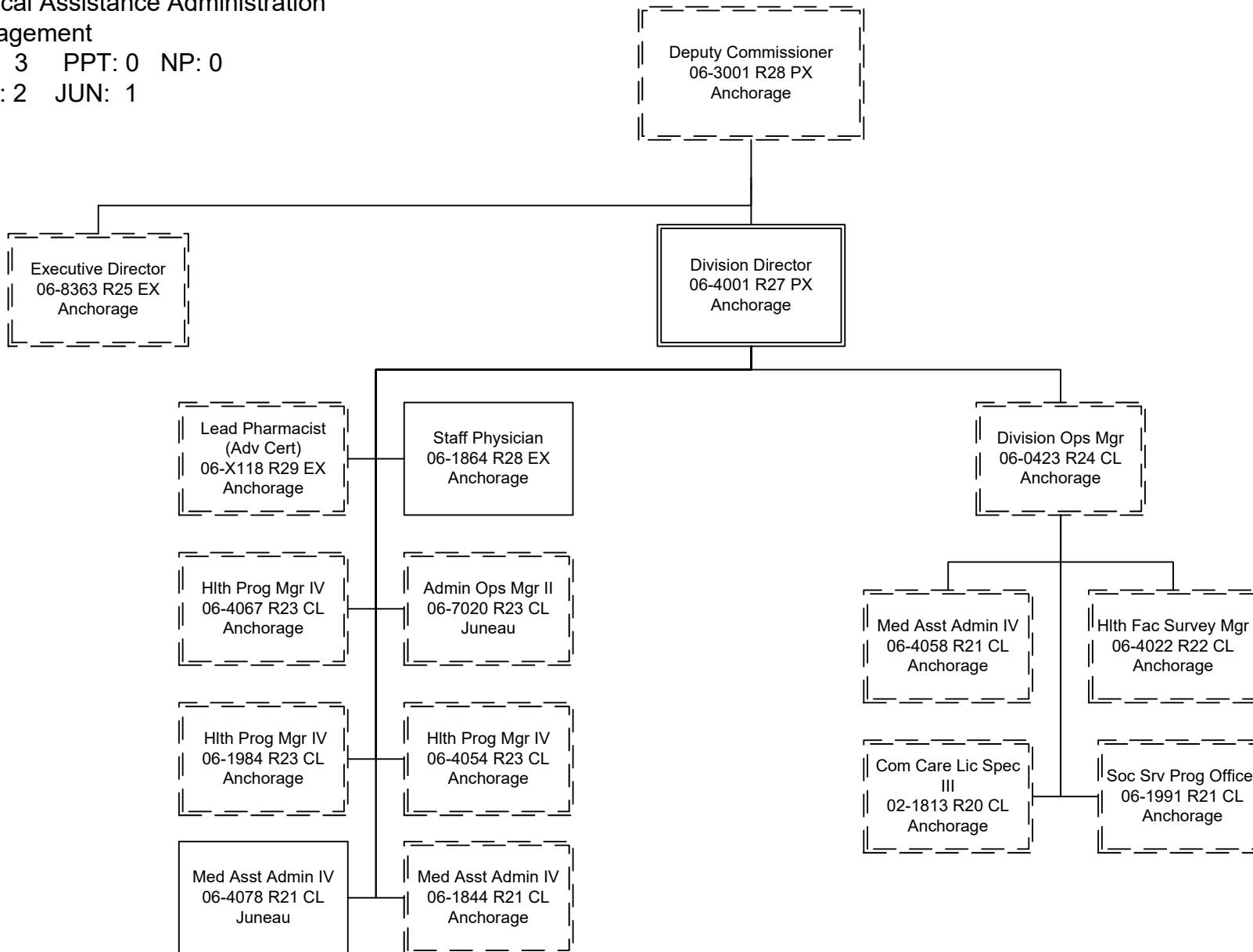

Department of Health & Social Services  
FY2019 Operating Budget  
Health Care Services  
Medical Assistance Administration  
PFT: 9 PPT: 0 NP: 0  
ANC: 6 JUN: 3

### ADMINISTRATIVE STAFF

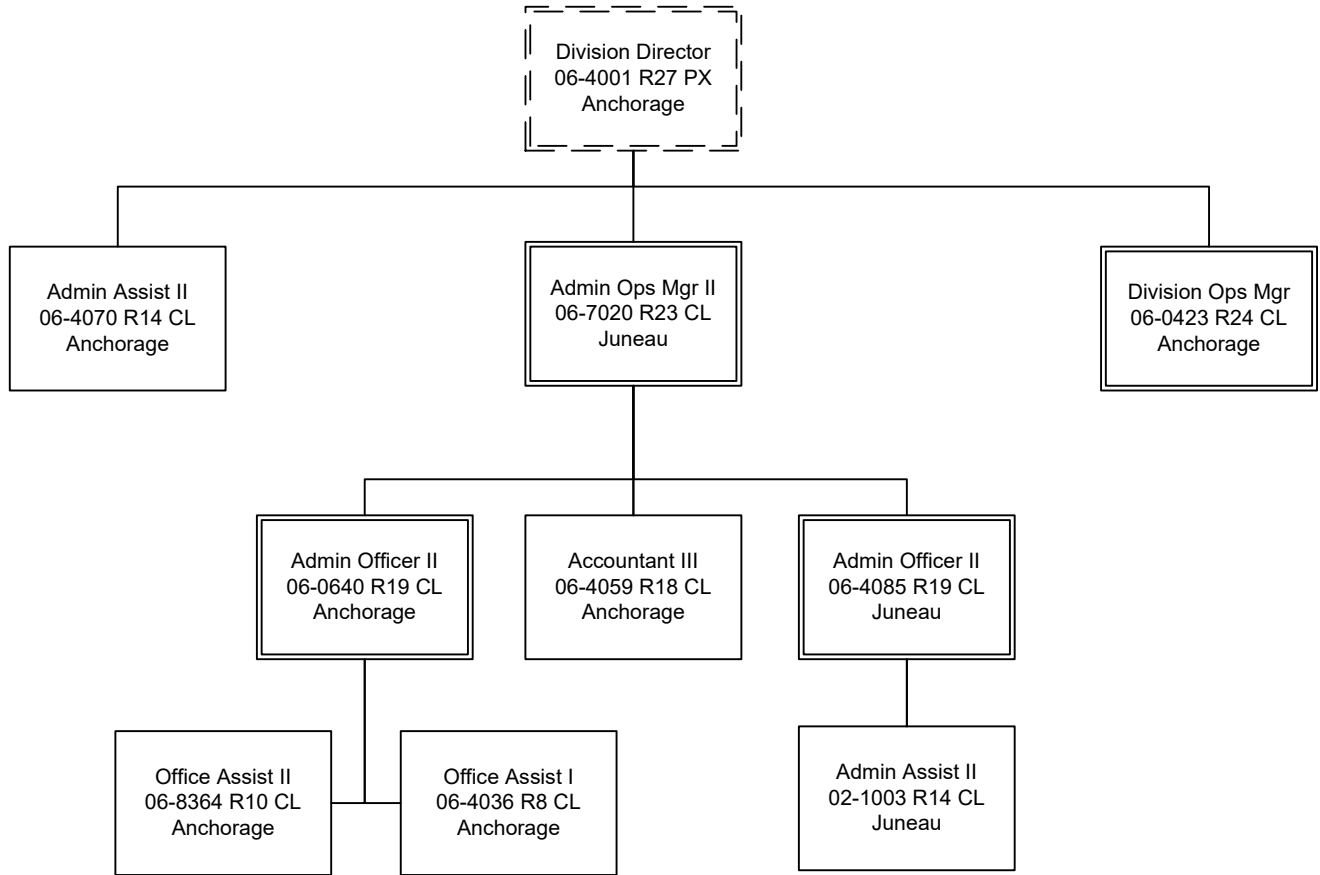

Department of Health & Social Services  
FY2019 Operating Budget  
Health Care Services  
Medical Assistance Administration  
PFT: 11 PPT: 0 NP: 0  
ANC: 11 JUN: 0

### ACCOUNTING & RECOVERY

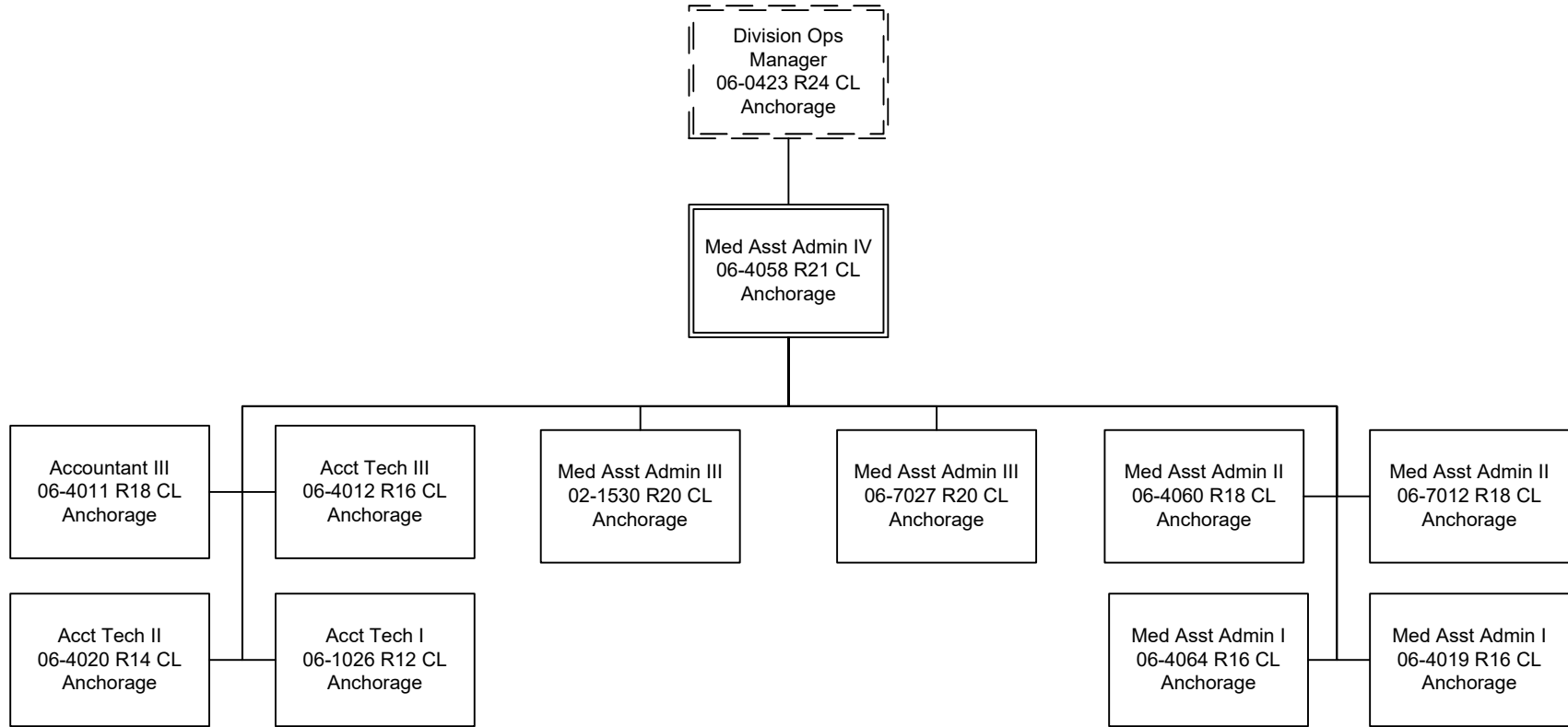

Department of Health & Social Services  
 FY2019 Operating Budget  
 Health Care Services  
 Medical Assistance Administration  
 PFT: 16 PPT: 0 NP: 0  
 ANC: 16 JUN: 0

MEDICAID MANAGEMENT INFORMATION SYSTEM &  
 DECISION SUPPORT

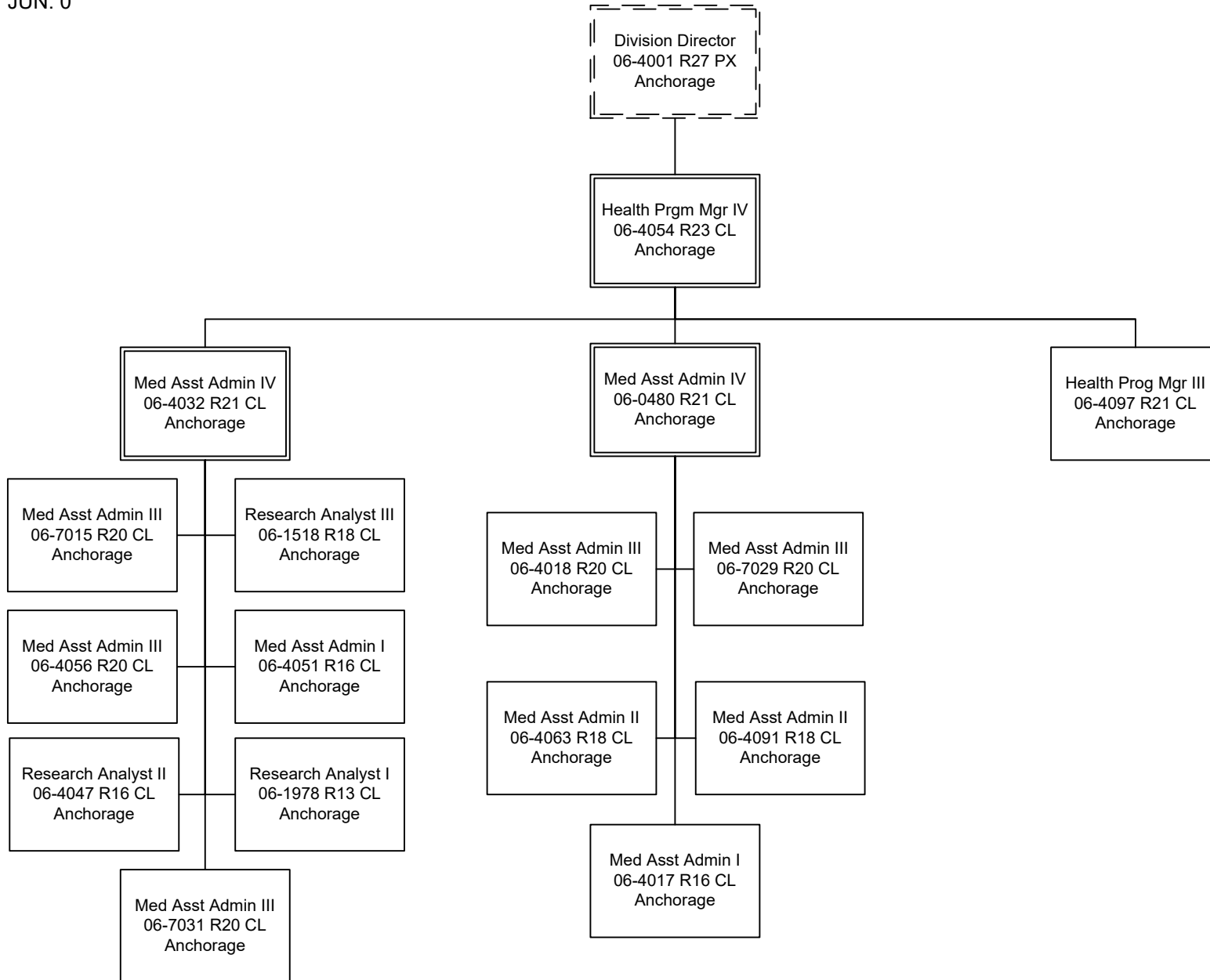

Department of Health & Social Services  
FY2018 Operating Budget  
Health Care Services  
Medical Assistance Administration  
PFT: 2 PPT: 0 NP: 0  
ANC: 2 JUN: 0

### HEALTH INFORMATION TECHNOLOGY

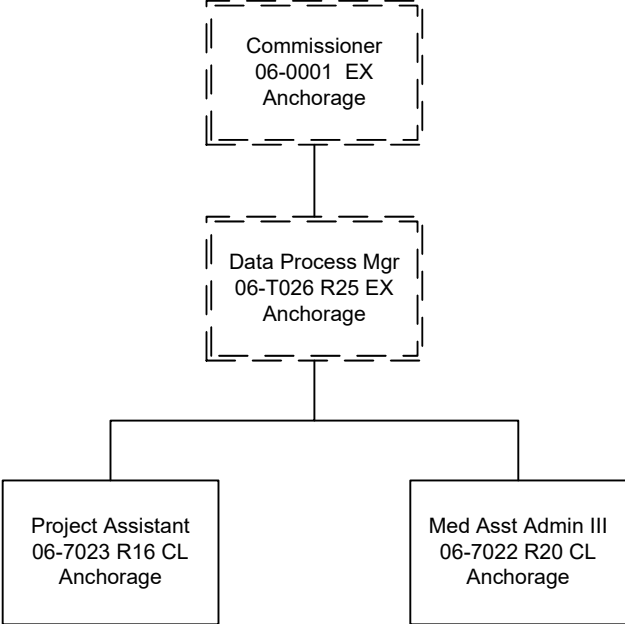

Department of Health & Social Services  
FY2019 Operating Budget  
Health Care Services  
Medical Assistance Administration  
PFT: 4 PPT: 0 NP: 0  
ANC: 4 JUN: 0

PHARMACY & ANCILLARY

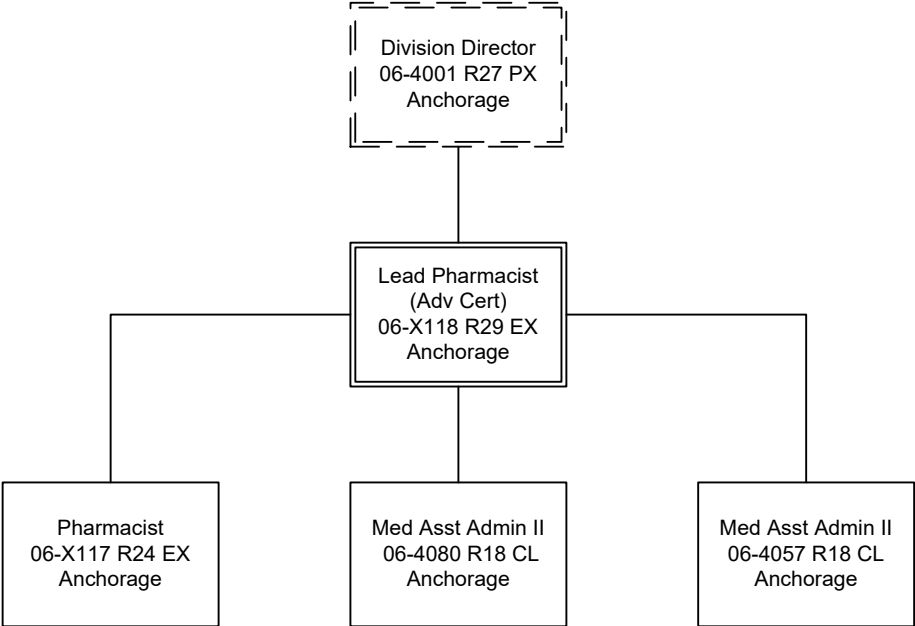

Department of Health & Social Services  
 FY2019 Operating Budget  
 Health Care Services  
 Medical Assistance Administration  
 PFT: 14 PPT: 0 NP: 2  
 ANC: 16 JUN: 0

## OPERATIONS

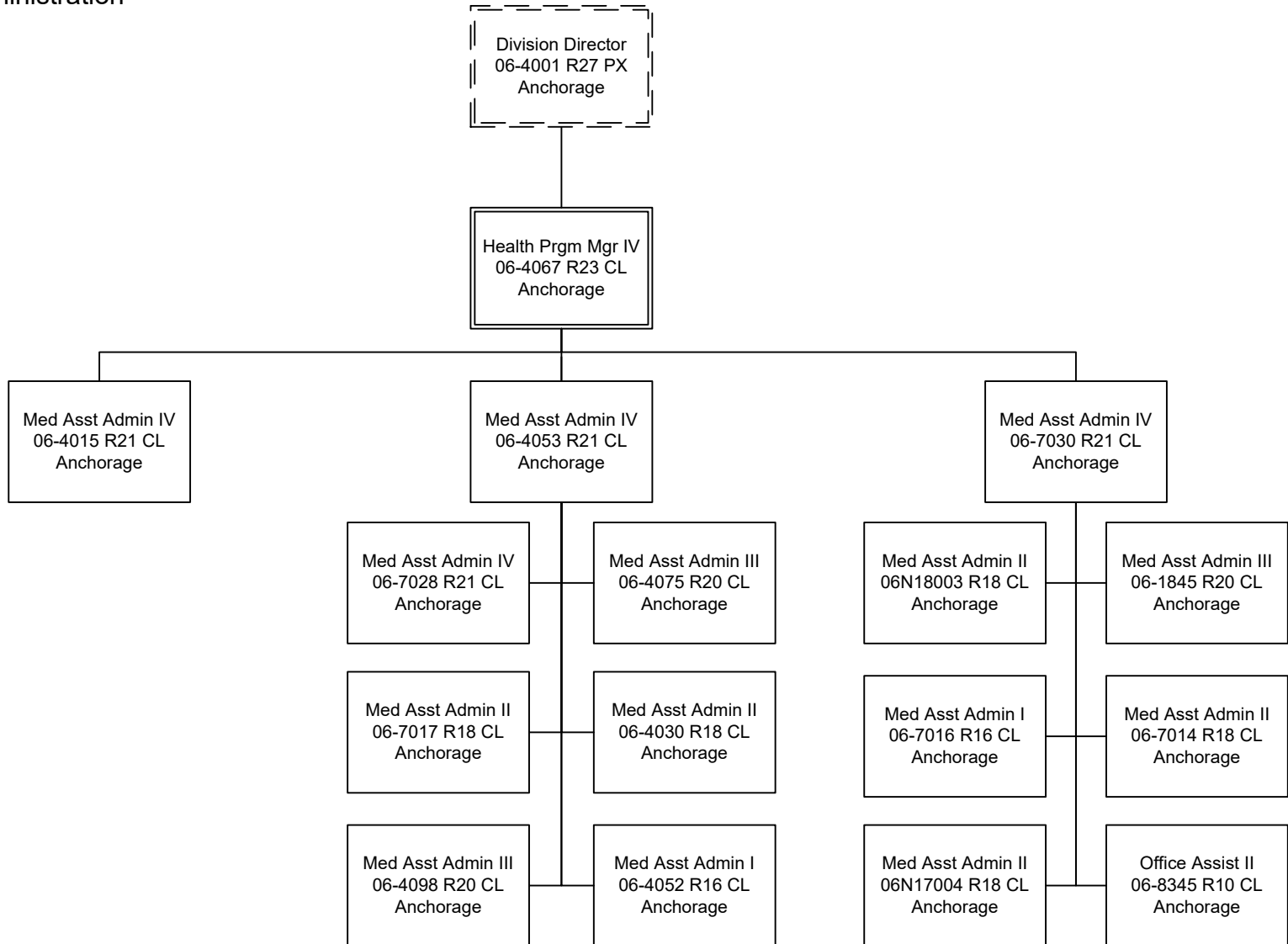

Department of Health & Social Services  
FY2019 Operating Budget  
Health Care Services  
Medical Assistance Administration  
PFT: 9 PPT: 0 NP: 1  
ANC: 10 JUN: 0

### QUALITY ASSURANCE

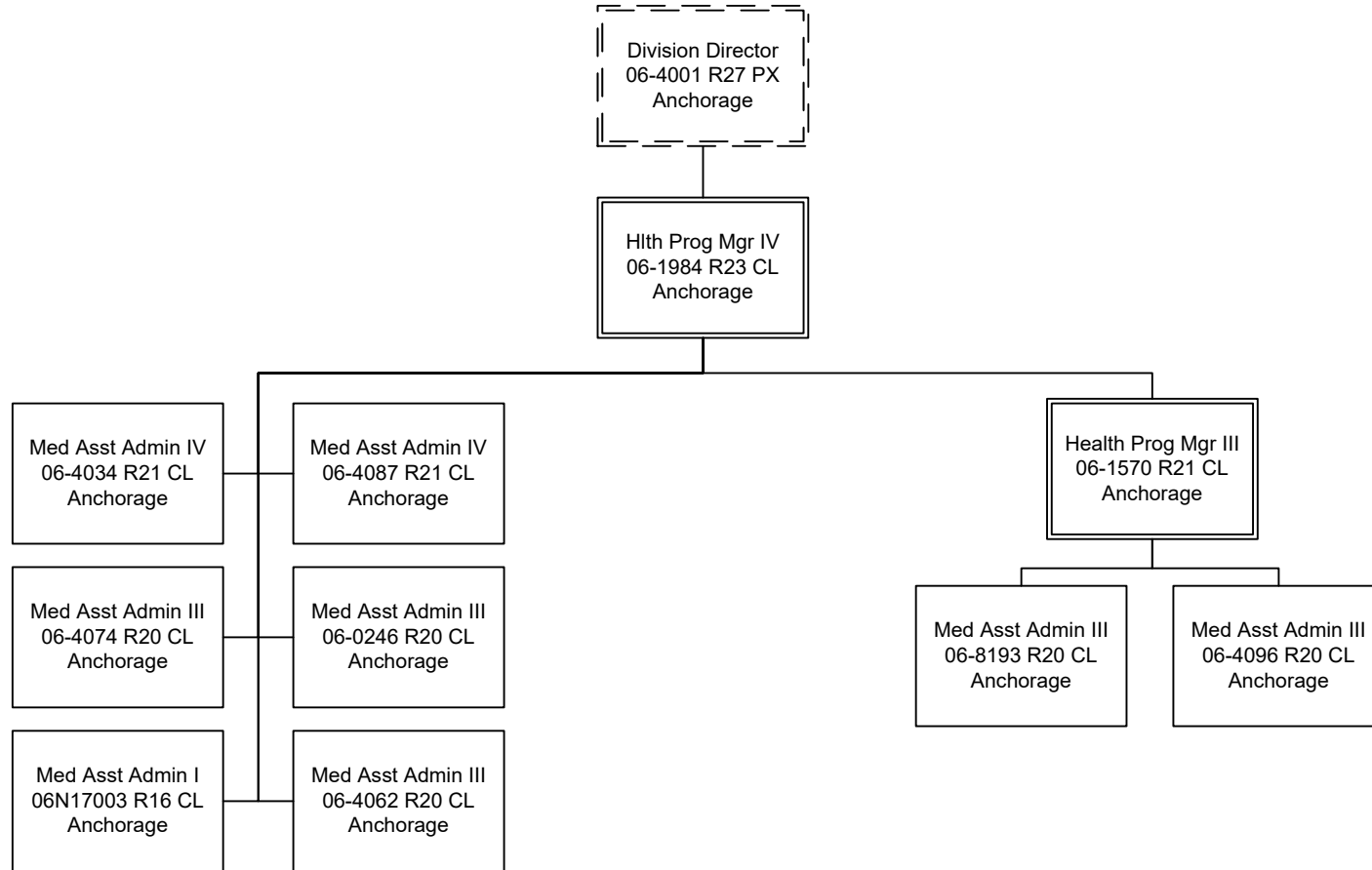



Department of Health & Social Services  
FY2019 Operating Budget  
Health Care Services  
Medical Assistance Administration  
PFT: 3 PPT: 0 NP: 1  
ANC: 3 JUN: 1

## PROGRAM REVIEW - MEDICAID

