

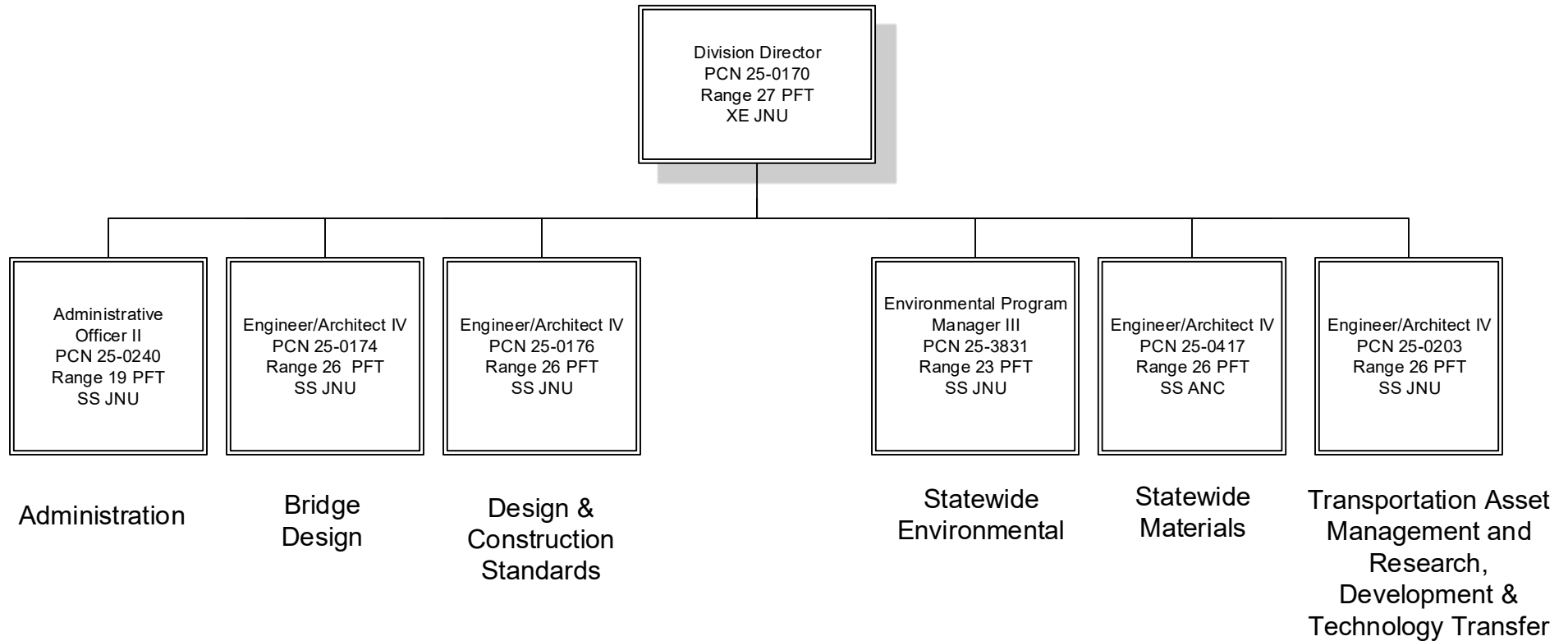

CHIEF ENGINEER'S OFFICE



Department of Transportation & Public Facilities
RDU: Design, Engineering and Construction
Component: Statewide Design and Engineering Services (2357)
FY2020 Governor's Budget
PFT – 65, PT – 1, NP – 4



ADMINISTRATION

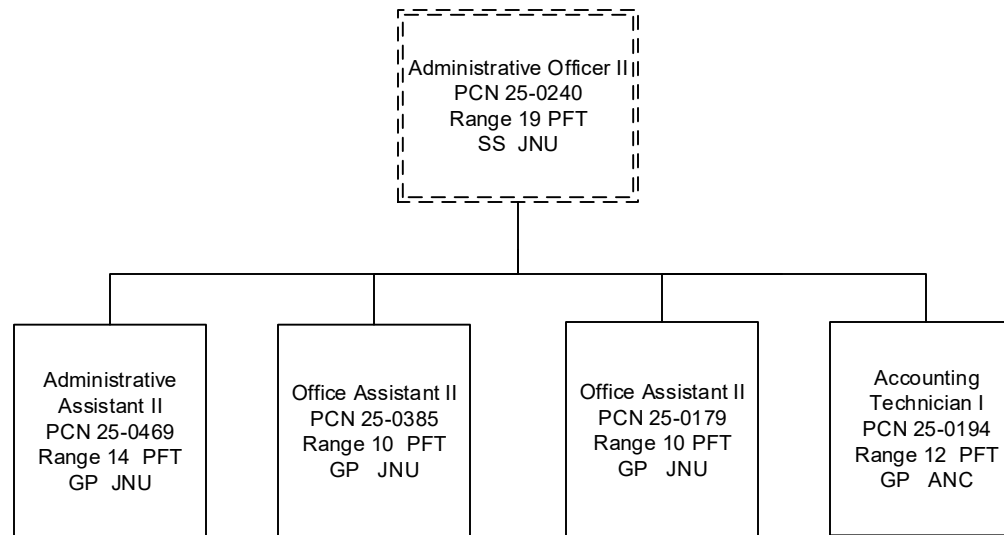



BRIDGE DESIGN

Engineer/Architect IV
 PCN 25-0174
 Range 26 PFT
 SS JNU

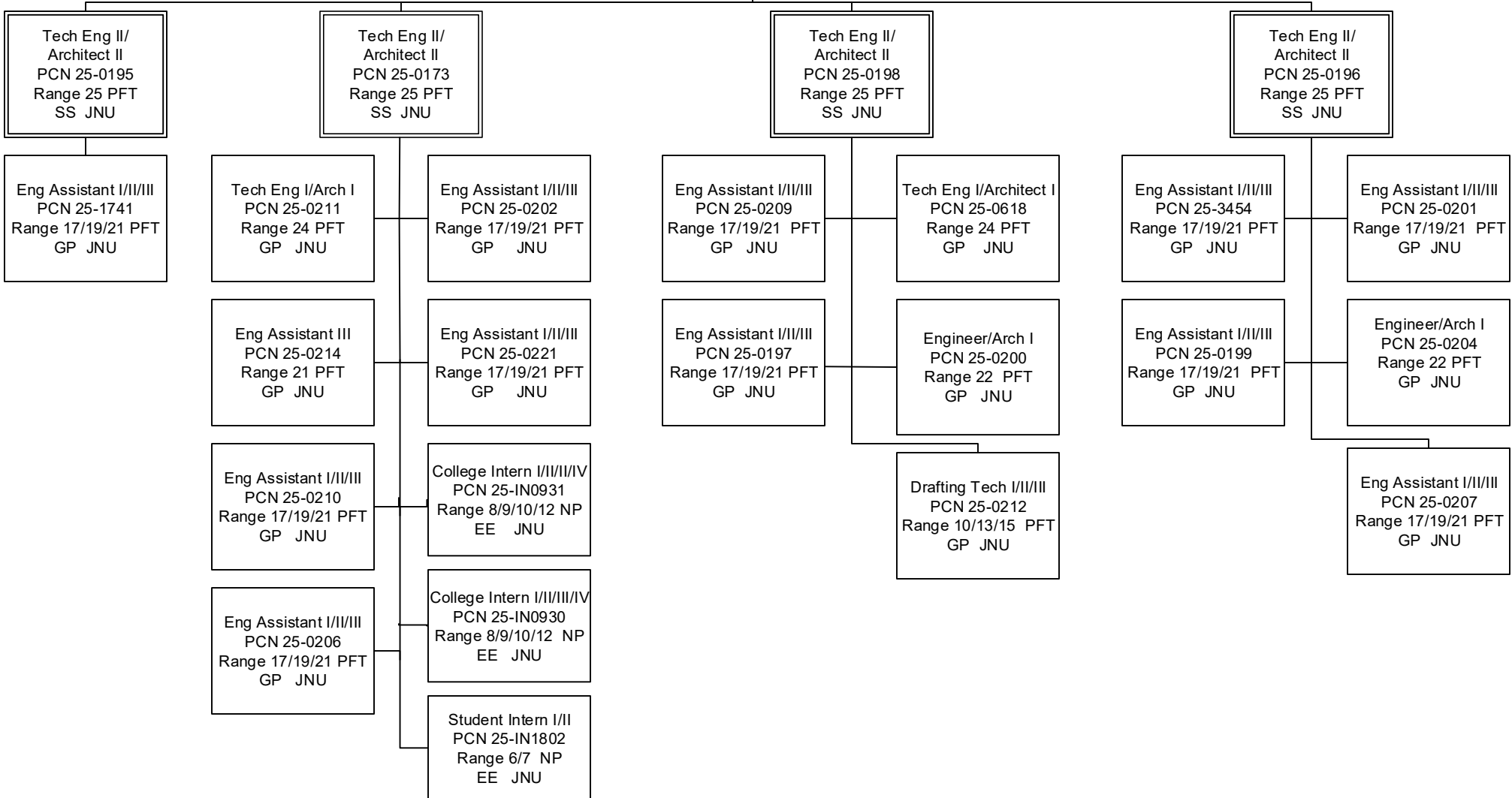



DESIGN & CONSTRUCTION STANDARDS

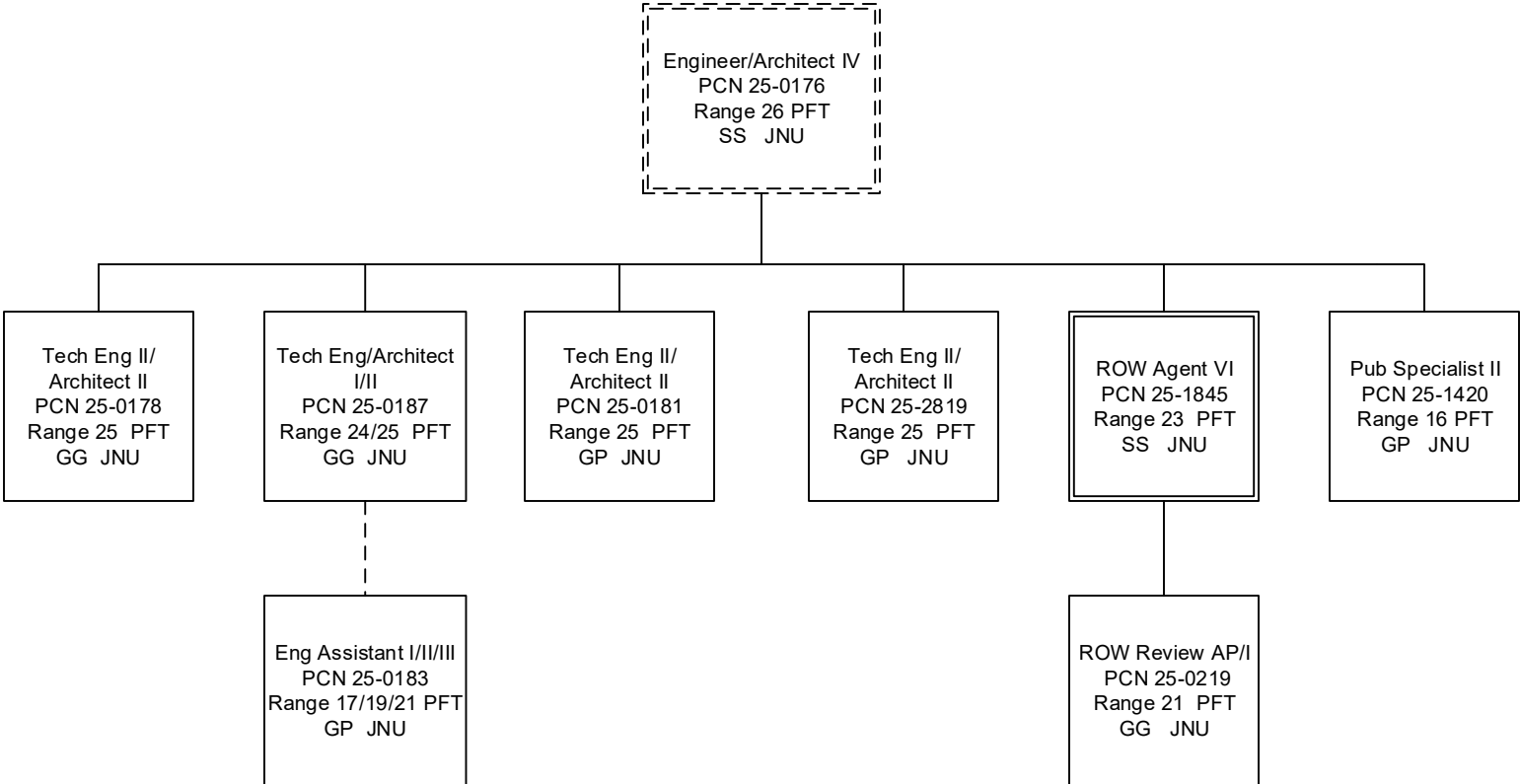

Department of Transportation & Public Facilities
RDU: Design, Engineering and Construction
Component: Statewide Design and Engineering Services (2357)
FY2020 Governor's Budget
PFT – 65, PT – 1, NP – 4



TRANSPORTATION ASSET MANAGEMENT AND RESEARCH, DEVELOPMENT AND TECHNOLOGY TRANSFER (RD&T2)

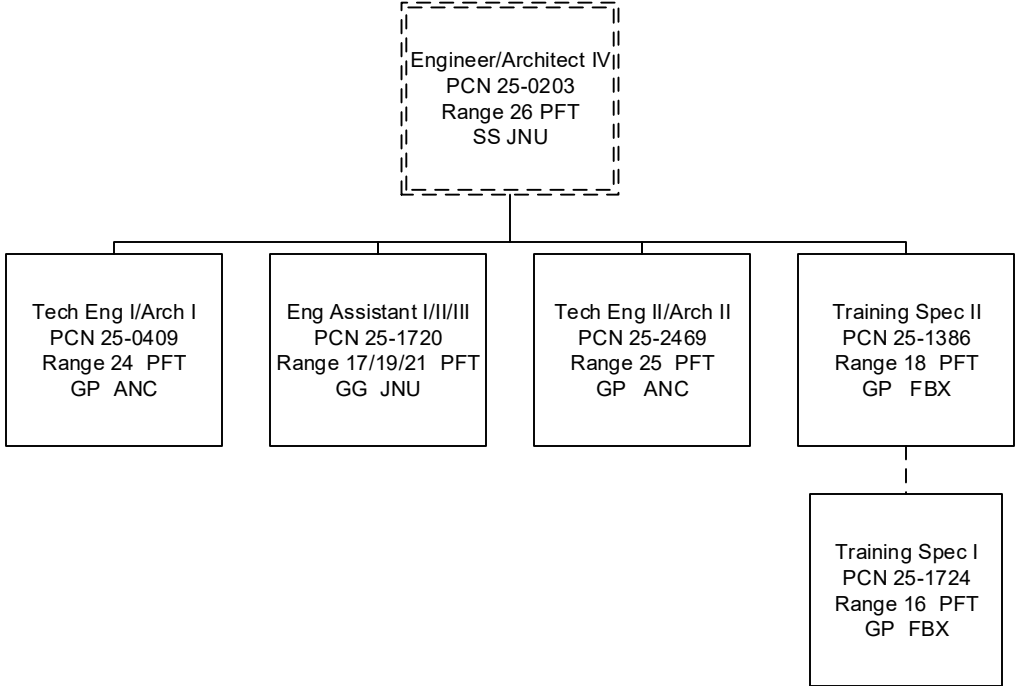

Department of Transportation & Public Facilities
RDU: Design, Engineering and Construction
Component: Statewide Design and Engineering Services (2357)
FY2020 Governor's Budget
PFT – 65, PT – 1, NP – 4



SPECIAL PROJECTS

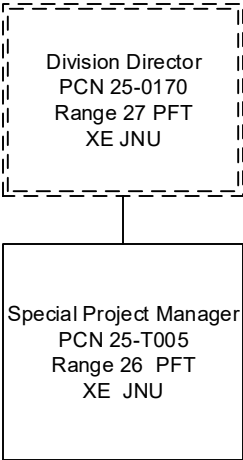



STATEWIDE ENVIRONMENTAL

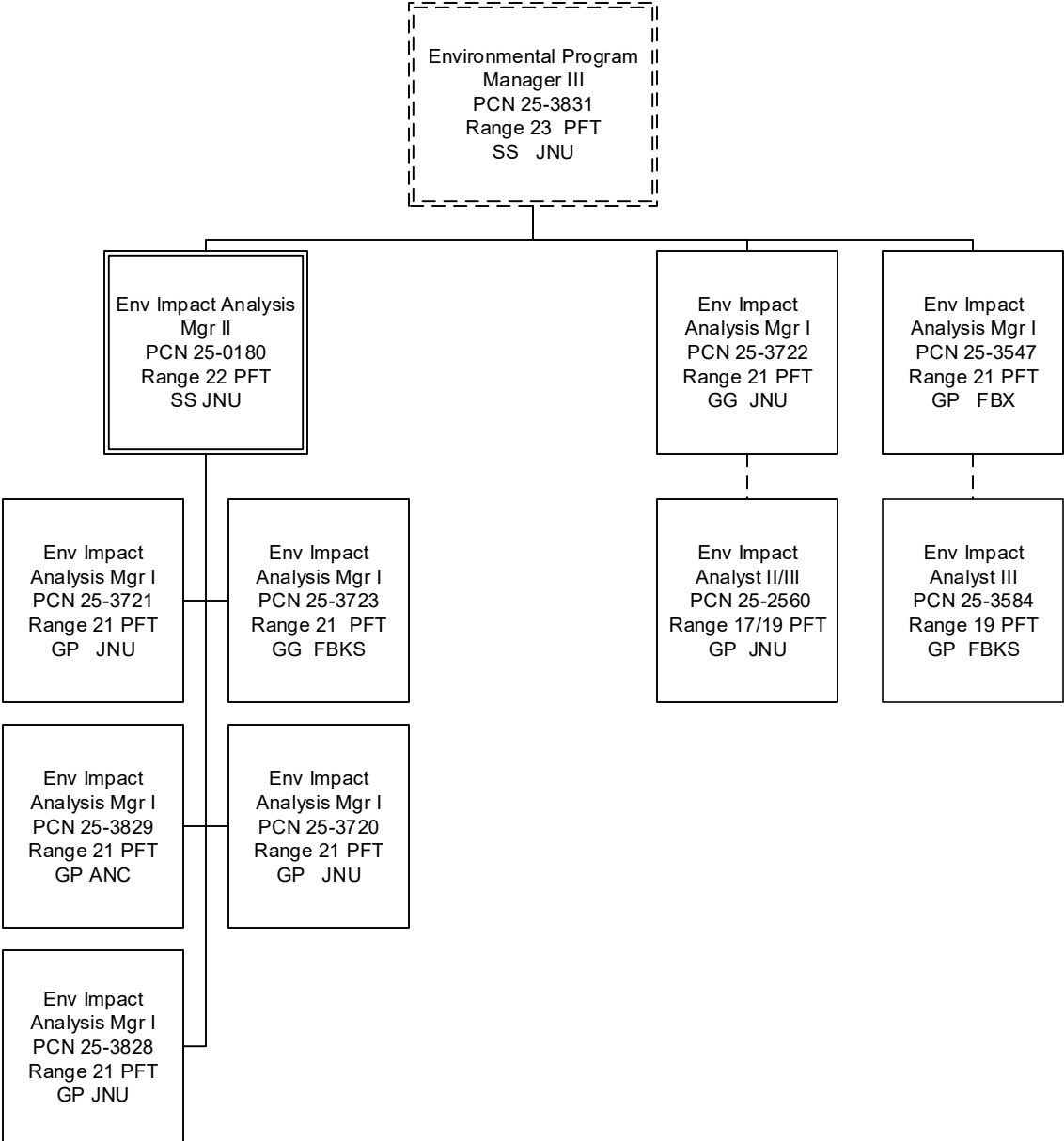



STATEWIDE MATERIALS

Engineer/Architect IV
 PCN 25-0417
 Range 26 PFT
 SS ANC

