

COMPONENT KEY

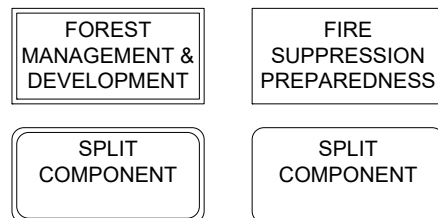

Fire Program Org Chart - 1 of 3

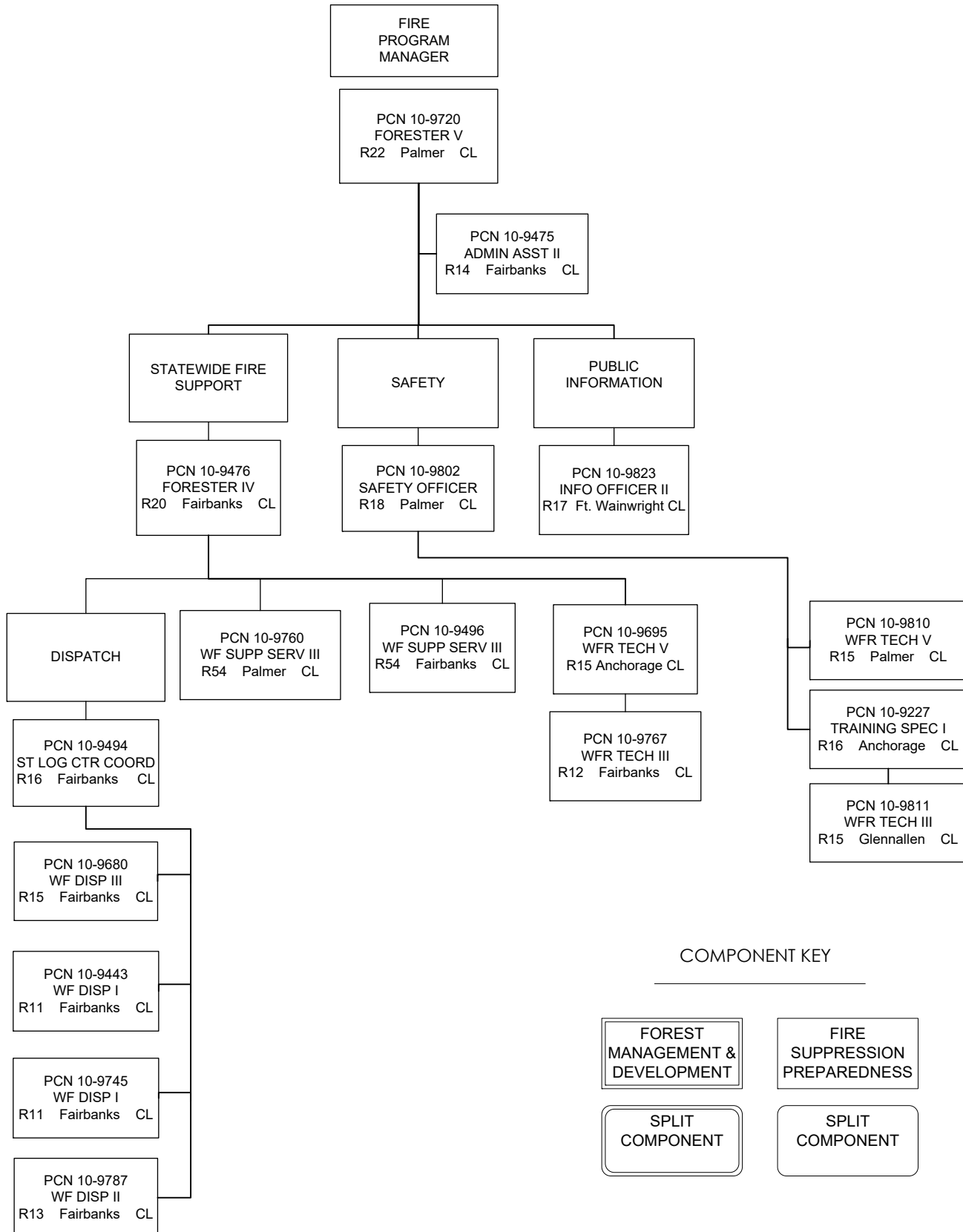

Fire Program Org Chart - 2 of 3

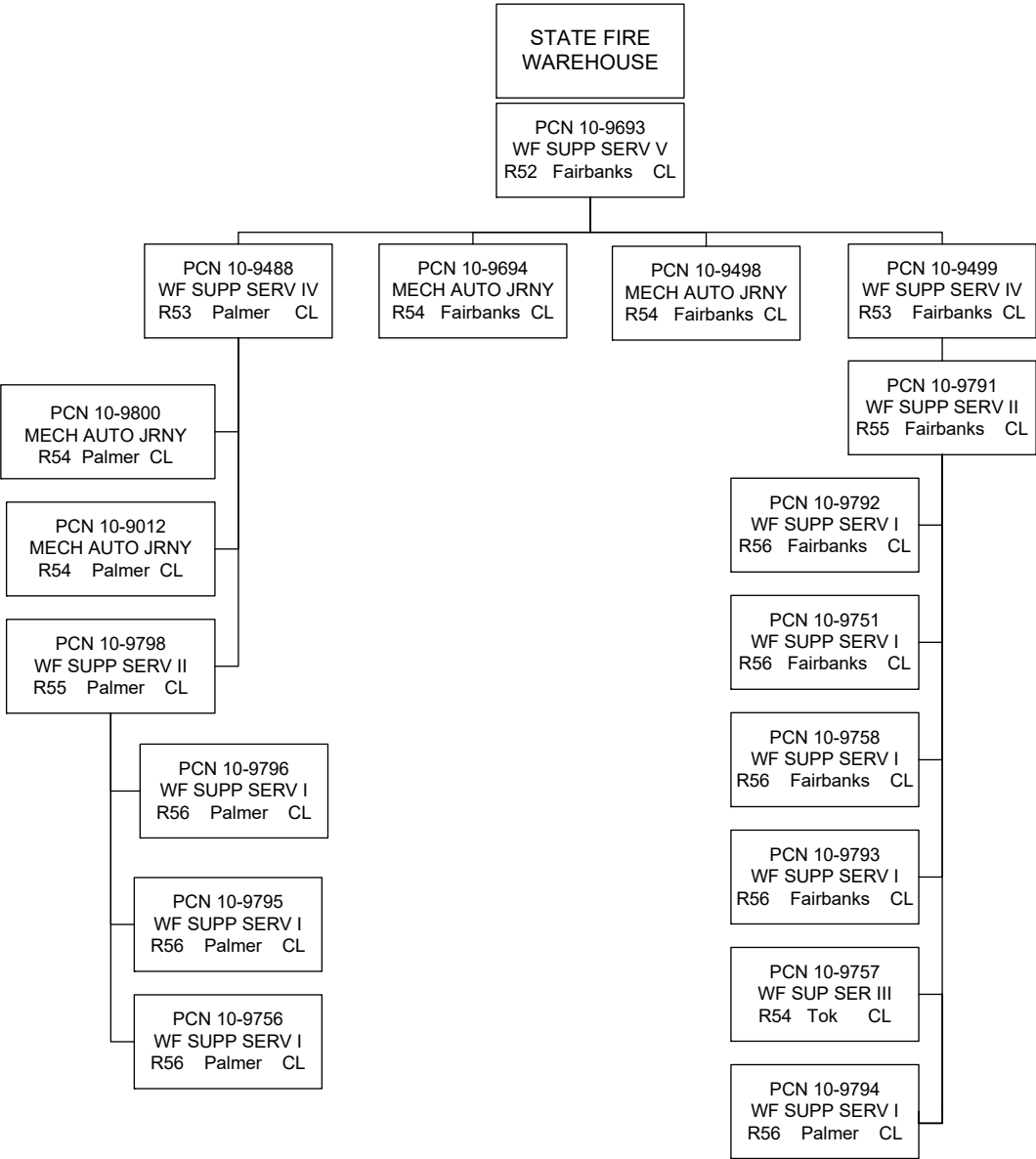

COMPONENT KEY

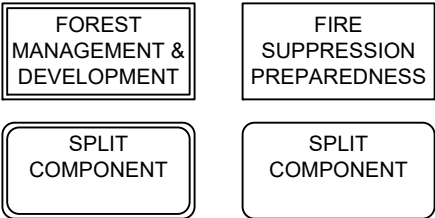

Fire Program Org Chart - 3 of 3

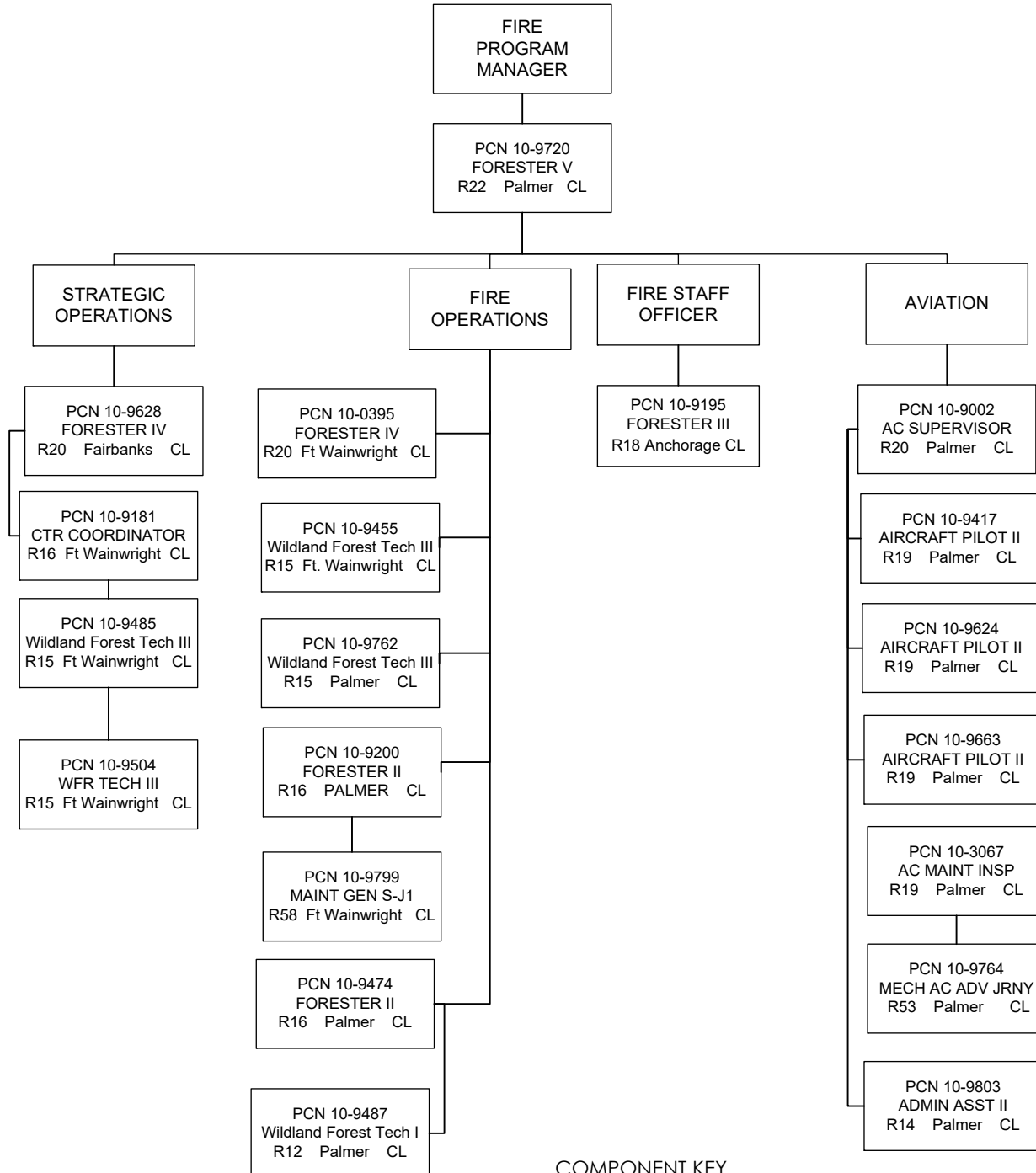

COMPONENT KEY

FOREST  
MANAGEMENT &  
DEVELOPMENT

FIRE  
SUPPRESSION  
PREPAREDNESS

SPLIT  
COMPONENT

SPLIT  
COMPONENT

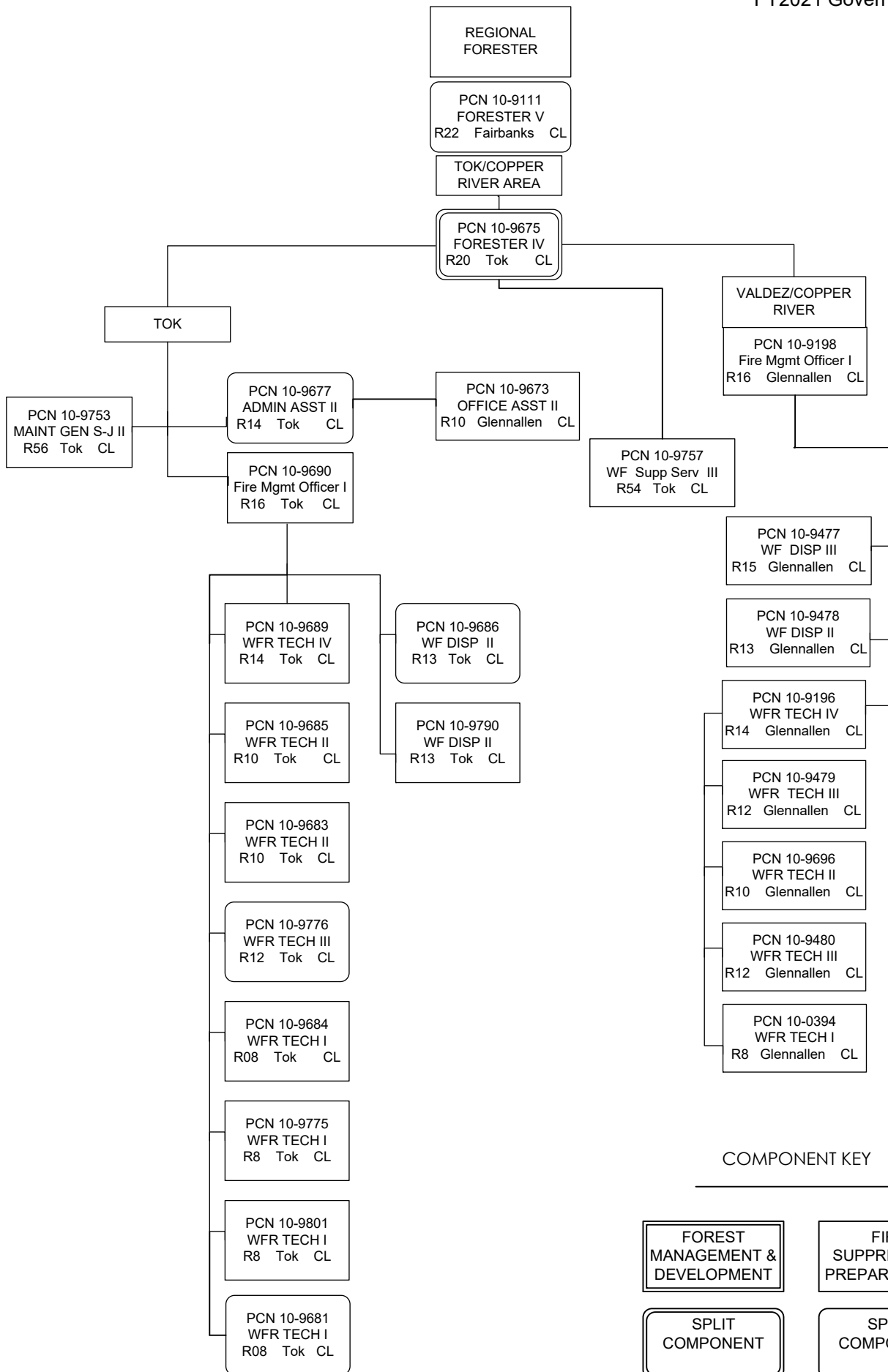

COMPONENT KEY

FOREST  
MANAGEMENT &  
DEVELOPMENT

FIRE  
SUPPRESSION  
PREPAREDNESS

SPLIT  
COMPONENT

SPLIT  
COMPONENT

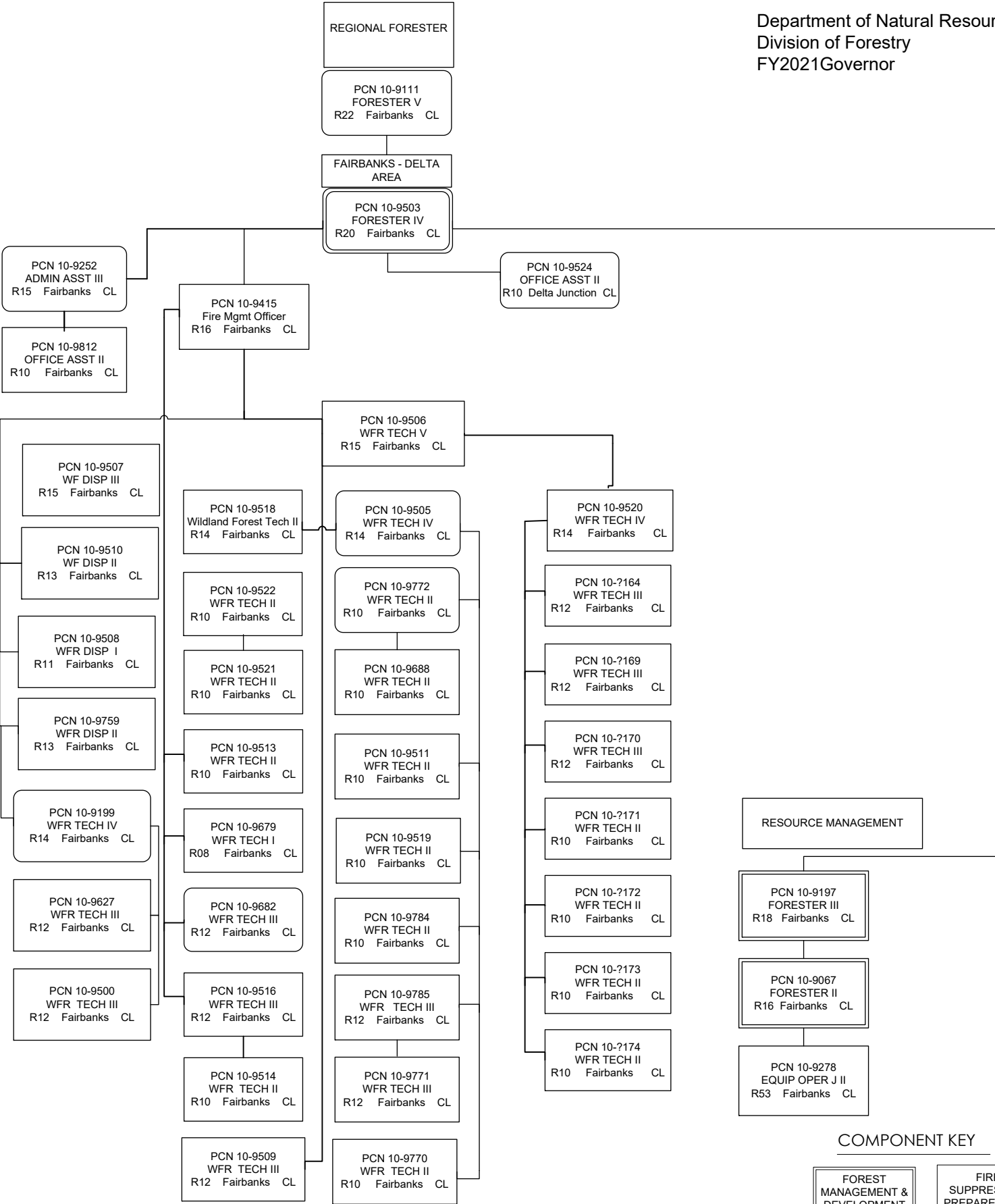

COMPONENT KEY

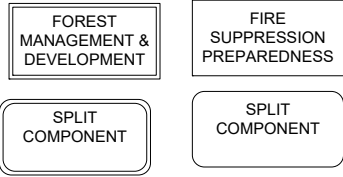

FBKS/DELTA AREA 2 of 2

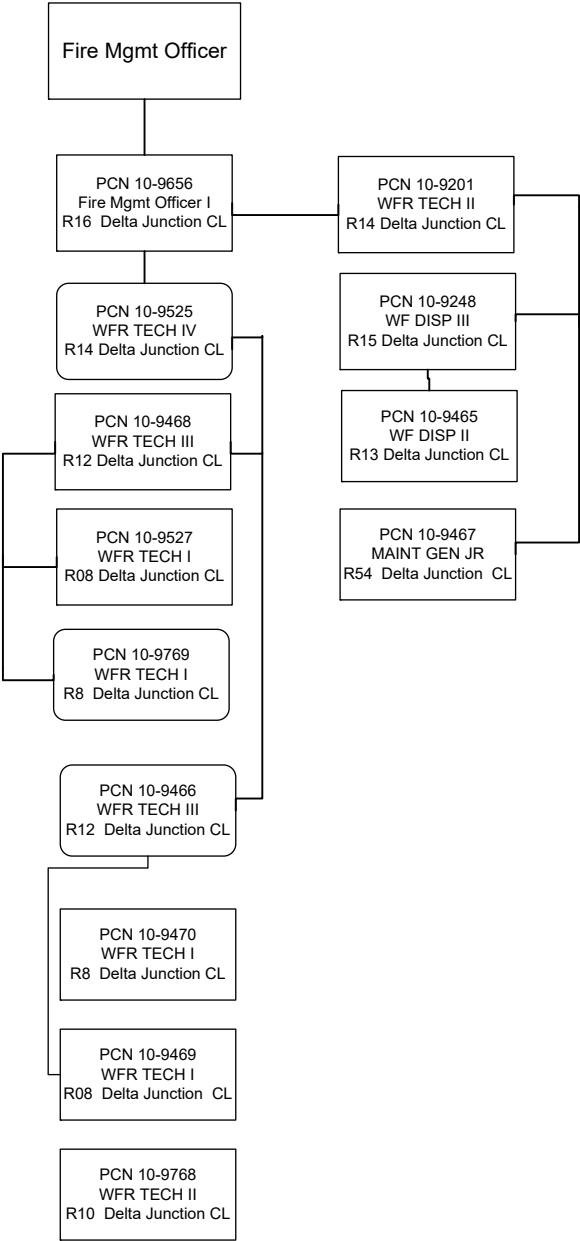

COMPONENT KEY

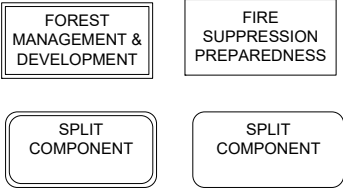

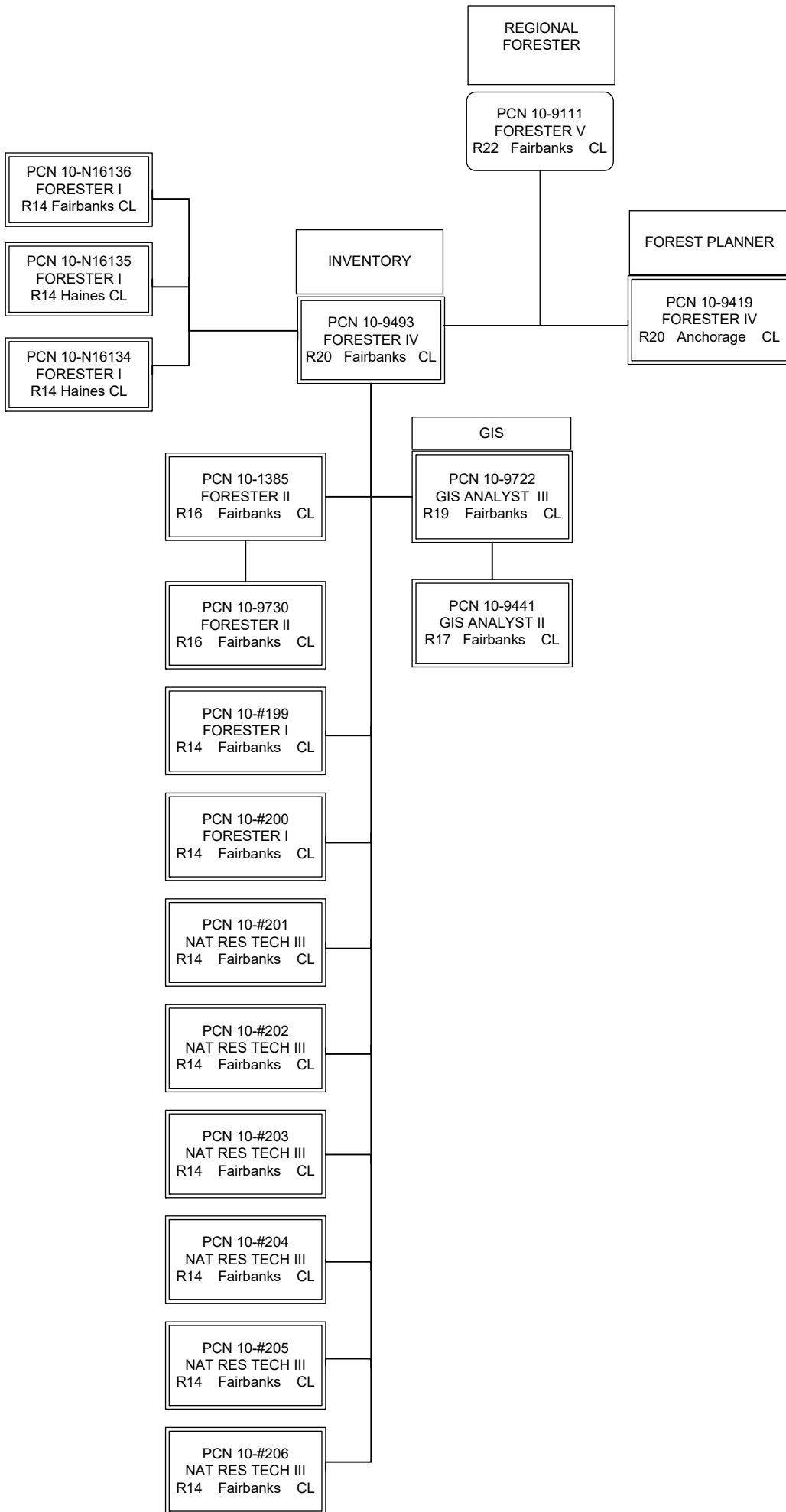

COMPONENT KEY

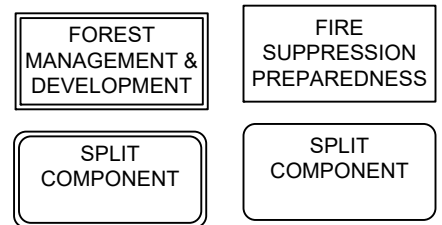



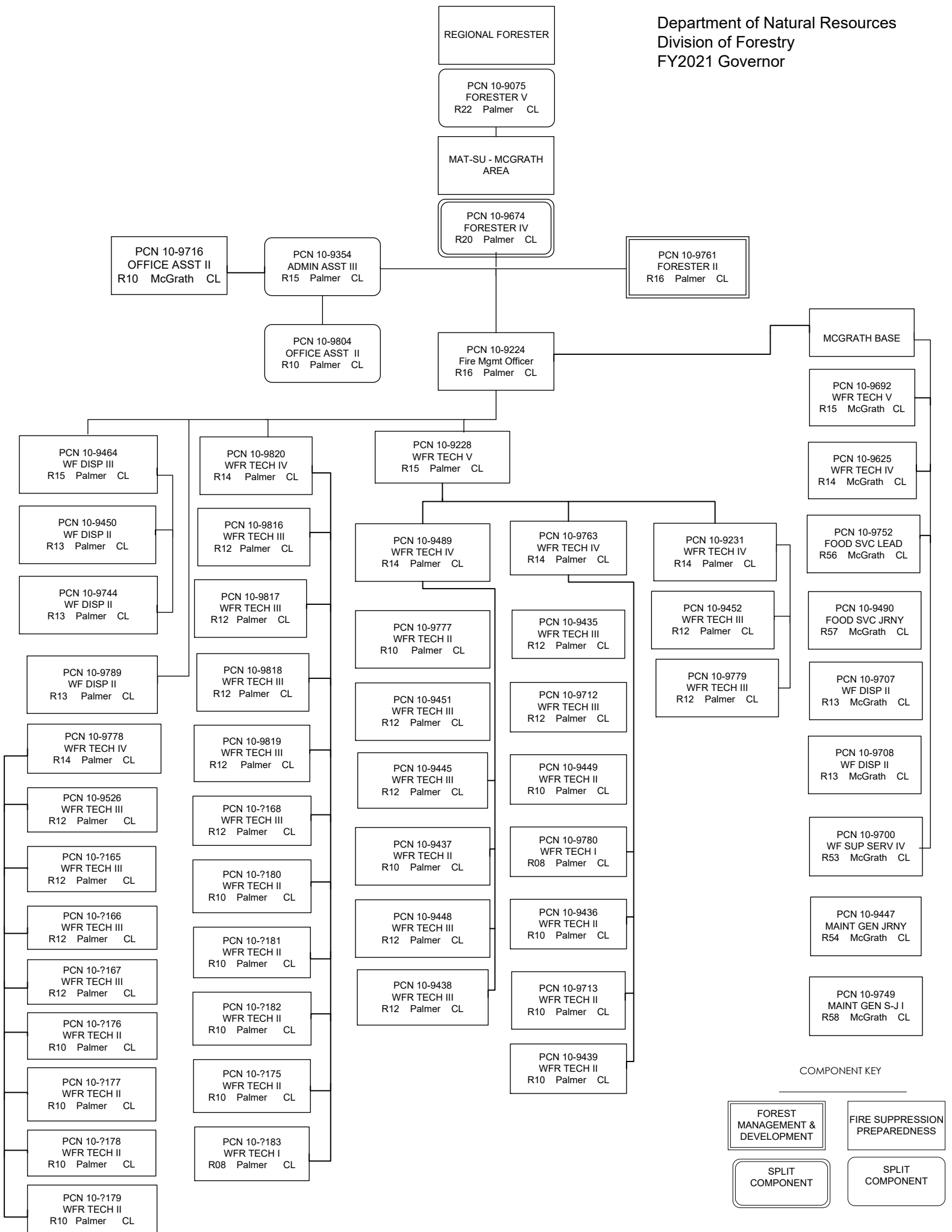

COMPONENT KEY

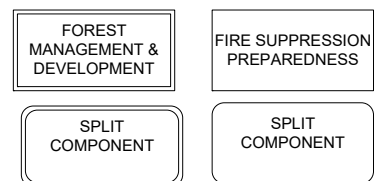

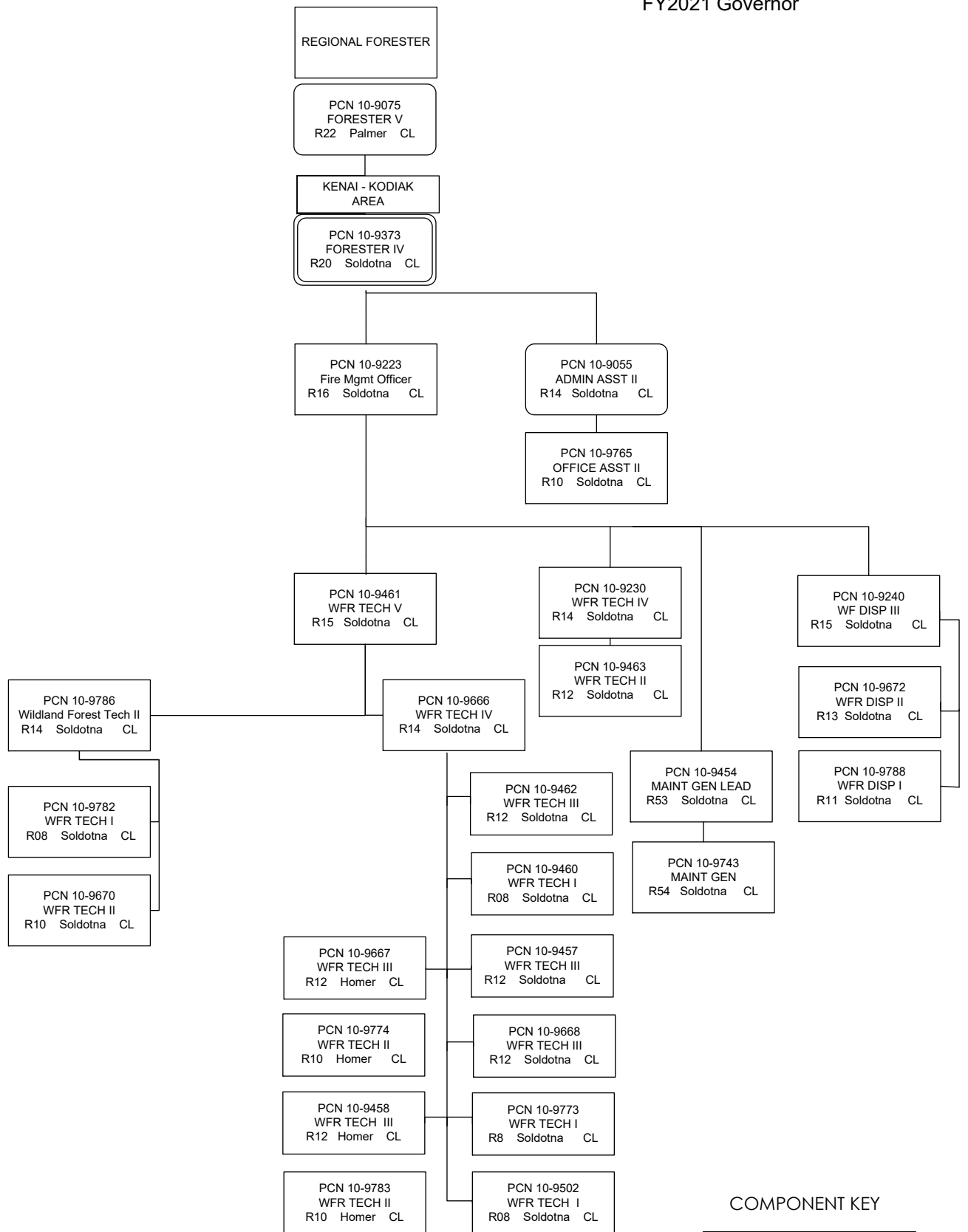

COMPONENT KEY

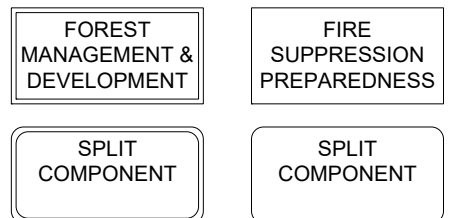

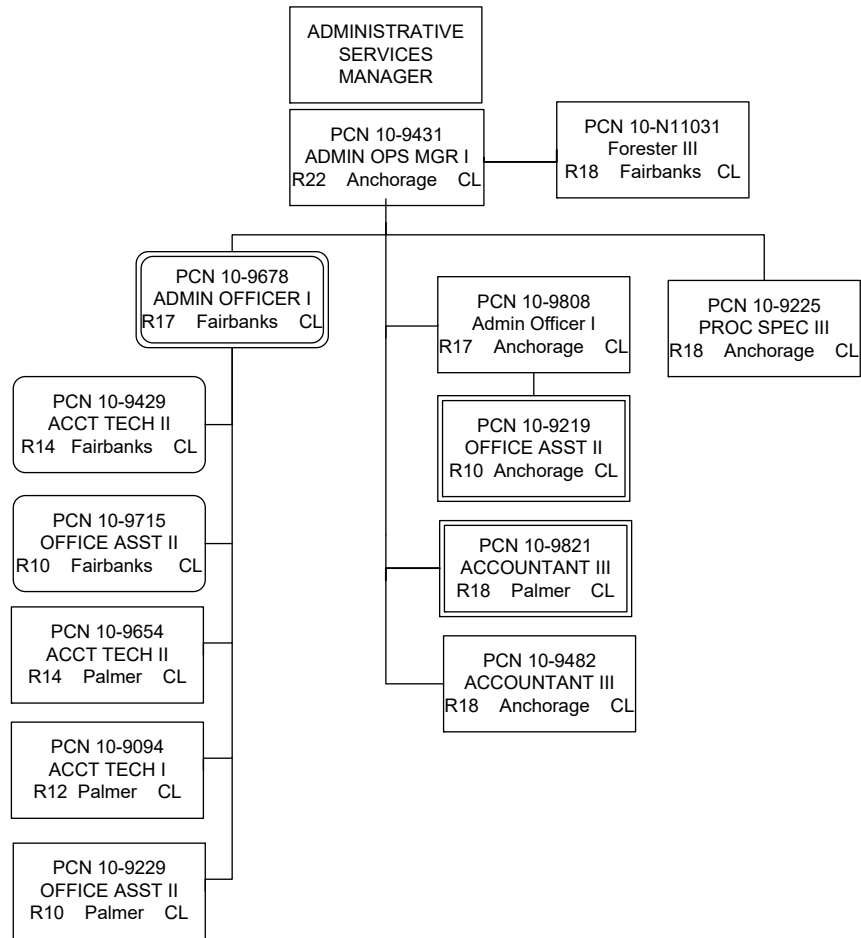

COMPONENT KEY

FOREST  
MANAGEMENT &  
DEVELOPMENT

FIRE  
SUPPRESSION  
PREPAREDNESS

SPLIT  
COMPONENT

SPLIT  
COMPONENT

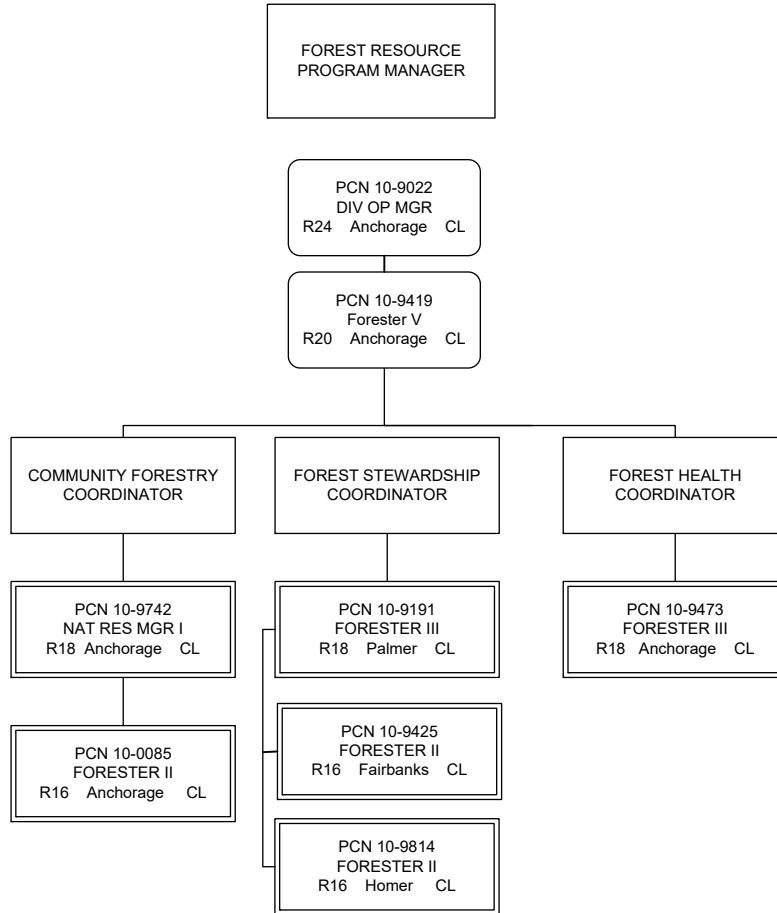

COMPONENT KEY

FOREST  
MANAGEMENT &  
DEVELOPMENT

FIRE  
SUPPRESSION  
PREPAREDNESS

SPLIT  
COMPONENT

SPLIT  
COMPONENT

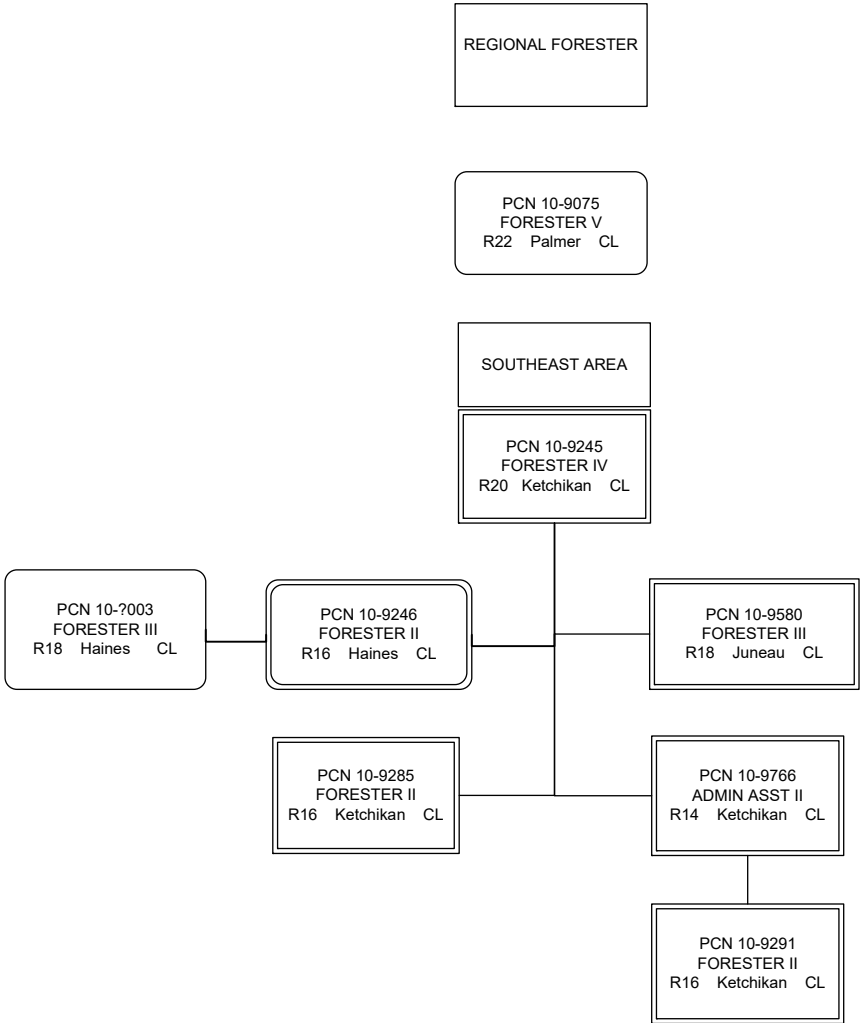

COMPONENT KEY

