

# **State of Alaska FY2021 Governor's Operating Budget**

## **Department of Fish and Game Wildlife Conservation Component Budget Summary**

**Component: Wildlife Conservation**

**Contribution to Department's Mission**

See RDU narrative.

**Core Services**

- See RDU narrative.

**Major Component Accomplishments in 2019**

See RDU narrative.

**Key Component Challenges**

See RDU narrative.

**Significant Changes in Results to be Delivered in FY2021**

See RDU narrative.

**Statutory and Regulatory Authority**

Alaska Statutes and Regulations

AS 16.05	Fish & Game Code
AS 16.20	Conservation and Protection of Alaska Fish and Game
AS 16.55	Shooting and Firearm Safety
5 AAC	Fish & Game

Federal Statutes and Regulations

Pittman-Robertson Wildlife Restoration Act (16 U.S.C. 669)	
43 CFR 12	Administration and Audit Requirements and Cost Principles for Assistance Programs
50 CFR 80	Administrative Requirements, Federal Aid in Wildlife Restoration Acts
2 CFR 225	Cost Principles for State, Local, Indian Tribal Governments (OMB Circular A-87)

**Contact Information**

**Contact:** Eddie Grasser, Director  
**Phone:** (907) 267-2339  
**E-mail:** eddie.grasser@alaska.gov

Wildlife Conservation Personal Services Information				
Authorized Positions			Personal Services Costs	
	FY2020 Management Plan	FY2021 Governor		
Full-time	227	228	Annual Salaries	19,780,920
Part-time	46	45	COLA	173,872
Nonpermanent	1	2	Premium Pay	112,159
			Annual Benefits	11,828,520
			<i>Less 6.62% Vacancy Factor</i>	(2,110,471)
			Lump Sum Premium Pay	160,000
<b>Totals</b>	<b>274</b>	<b>275</b>	<b>Total Personal Services</b>	<b>29,945,000</b>

Position Classification Summary					
Job Class Title	Anchorage	Fairbanks	Juneau	Others	Total
Accountant III	0	0	1	0	1
Accounting Technician I	2	2	1	0	5
Accounting Technician II	0	0	1	0	1
Administrative Assistant II	3	1	1	1	6
Administrative Assistant III	0	0	0	1	1
Administrative Officer I	2	1	2	1	6
Admn OPS Mgr I	0	0	1	0	1
Analyst/Programmer III	2	0	2	0	4
Analyst/Programmer IV	2	0	1	2	5
Analyst/Programmer V	1	1	1	0	3
Asst Dir F&G	0	0	1	1	2
Biometrician I	0	1	0	0	1
Biometrician II	0	1	1	1	3
Biometrician III	2	2	1	0	5
Boat Officer II	1	0	0	0	1
Budget Analyst II	0	0	1	0	1
Data Processing Manager I	0	0	1	0	1
Division Director - Px	0	0	0	1	1
Division Operations Manager	0	0	1	0	1
Education Associate II	2	1	1	0	4
Education Associate III	2	1	1	2	6
Fish & Game Coordinator	4	2	1	3	10
Fish & Game Program Technician	1	0	1	10	12
Fish & Wildlife Technician II	0	1	0	0	1
Fish & Wildlife Technician III	5	7	3	5	20
Fish & Wildlife Technician IV	5	0	1	4	10
Fish & Wildlife Technician V	2	0	1	1	4
Gis Analyst II	1	0	0	1	2
Gis Analyst III	2	1	0	0	3
Habitat Biologist II	1	0	0	1	2
Habitat Biologist III	3	1	0	0	4
Habitat Biologist IV	1	0	0	0	1
Information Officer II	1	0	1	0	2
Nat Res Speciii	1	0	0	0	1
Natural Resource Manager II	1	0	0	0	1
Natural Resource Manager III	1	0	0	0	1

Position Classification Summary					
Job Class Title	Anchorage	Fairbanks	Juneau	Others	Total
Natural Resource Specialist II	1	0	0	0	1
Office Assistant I	1	0	0	0	1
Office Assistant II	0	1	0	0	1
Office Assistant III	0	0	0	1	1
Office Assistant IV	1	0	0	0	1
Program Coordinator II	2	0	2	1	5
Project Assistant	1	0	0	2	3
Publications Specialist II	0	1	1	0	2
Research Analyst III	1	0	2	0	3
Statistical Technician I	1	0	0	0	1
Statistical Technician II	0	1	0	0	1
Training Specialist II	1	0	0	0	1
Wildlife Biologist I	2	2	3	4	11
Wildlife Biologist II	4	8	3	15	30
Wildlife Biologist III	7	17	8	24	56
Wildlife Biologist IV	4	4	2	5	15
Wildlife Physiologist II	1	1	0	2	4
Wildlife Physiologist III	0	0	1	0	1
Wildlife Scientist I	0	0	1	0	1
Wildlife Scientist II	0	0	1	0	1
Wildlife Veterinarian	0	1	0	1	2
<b>Totals</b>	<b>75</b>	<b>59</b>	<b>51</b>	<b>90</b>	<b>275</b>

**Component Detail All Funds**  
**Department of Fish and Game**

**Component:** Wildlife Conservation (473)  
**RDU:** Wildlife Conservation (147)

Non-Formula Component

	FY2019 Actuals	FY2020 Conference Committee	FY2020 Authorized	FY2020 Management Plan	FY2021 Governor	FY2020 Management Plan vs FY2021 Governor	
71000 Personal Services	28,978.6	29,057.0	29,057.0	29,807.0	29,945.0	138.0	0.5%
72000 Travel	1,055.6	1,305.2	1,305.2	1,305.2	1,305.2	0.0	0.0%
73000 Services	14,336.8	14,911.9	14,771.9	14,771.9	14,771.9	0.0	0.0%
74000 Commodities	3,055.9	3,359.0	3,359.0	3,359.0	3,329.0	-30.0	-0.9%
75000 Capital Outlay	279.6	0.0	0.0	50.0	80.0	30.0	60.0%
77000 Grants, Benefits	0.0	800.0	800.0	0.0	0.0	0.0	0.0%
78000 Miscellaneous	0.0	0.0	0.0	0.0	0.0	0.0	0.0%
<b>Totals</b>	<b>47,706.5</b>	<b>49,433.1</b>	<b>49,293.1</b>	<b>49,293.1</b>	<b>49,431.1</b>	<b>138.0</b>	<b>0.3%</b>
<b>Fund Sources:</b>							
1002 Fed Rcpts (Fed)	30,966.5	32,695.1	32,695.1	32,695.1	32,783.6	88.5	0.3%
1003 G/F Match (UGF)	41.2	41.6	41.6	41.6	41.6	0.0	0.0%
1004 Gen Fund (UGF)	1,921.5	1,810.0	1,670.0	1,670.0	1,665.6	-4.4	-0.3%
1007 I/A Rcpts (Other)	423.9	561.5	561.5	561.5	564.1	2.6	0.5%
1024 Fish/Game (Other)	12,005.0	12,875.0	12,875.0	12,875.0	12,920.0	45.0	0.3%
1061 CIP Rcpts (Other)	1,153.0	933.7	933.7	933.7	939.2	5.5	0.6%
1108 Stat Desig (Other)	195.4	516.2	516.2	516.2	517.0	0.8	0.2%
1223 CharterRLF (DGF)	1,000.0	0.0	0.0	0.0	0.0	0.0	0.0%
<b>Unrestricted General (UGF)</b>	<b>1,962.7</b>	<b>1,851.6</b>	<b>1,711.6</b>	<b>1,711.6</b>	<b>1,707.2</b>	<b>-4.4</b>	<b>-0.3%</b>
<b>Designated General (DGF)</b>	<b>1,000.0</b>	<b>0.0</b>	<b>0.0</b>	<b>0.0</b>	<b>0.0</b>	<b>0.0</b>	<b>0.0%</b>
<b>Other Funds</b>	<b>13,777.3</b>	<b>14,886.4</b>	<b>14,886.4</b>	<b>14,886.4</b>	<b>14,940.3</b>	<b>53.9</b>	<b>0.4%</b>
<b>Federal Funds</b>	<b>30,966.5</b>	<b>32,695.1</b>	<b>32,695.1</b>	<b>32,695.1</b>	<b>32,783.6</b>	<b>88.5</b>	<b>0.3%</b>
<b>Positions:</b>							
Permanent Full Time	223	223	223	227	228	1	0.4%
Permanent Part Time	47	47	47	46	45	-1	-2.2%
Non Permanent	1	1	1	1	2	1	100.0%

**Change Record Detail - Multiple Scenarios with Descriptions**  
**Department of Fish and Game**

**Component:** Wildlife Conservation (473)  
**RDU:** Wildlife Conservation (147)

Scenario/Change Record Title	Trans Type	Totals	Personal Services	Travel	Services	Commodities	Capital Outlay	Grants, Benefits	Miscellaneous	Positions		NP
										PFT	PPT	
***** Changes From FY2020 Conference Committee To FY2020 Authorized *****												
<b>FY2020 Conference Committee</b>												
	ConfCom	49,433.1	29,057.0	1,305.2	14,911.9	3,359.0	0.0	800.0	0.0	223	47	1
1002 Fed Rcpts		32,695.1										
1003 G/F Match		41.6										
1004 Gen Fund		1,810.0										
1007 I/A Rcpts		561.5										
1024 Fish/Game		12,875.0										
1061 CIP Rcpts		933.7										
1108 Stat Desig		516.2										
<b>Reduce Fish and Game Fund Authority to Provide Match for Pittman-Robertson Funds</b>												
	Veto	-300.0	0.0	0.0	0.0	0.0	0.0	-300.0	0.0	0	0	0
1024 Fish/Game		-300.0										
The State of Alaska receives an apportionment of federal funding for the Pittman-Robertson (PR) Act. The funding must then be matched 3:1. The Alaska Department of Fish & Game estimates the apportionment each year and then establishes the amount of match needed in order to not revert PR funding. The division can absorb this reduction with little impact to the department.												
The State's fiscal reality dictates a reduction in expenditures across all agencies.												
<b>Reverse Fish and Game Fund Authority to Provide Match for Pittman-Robertson Funds Reduction</b>												
	Inc	300.0	0.0	0.0	0.0	0.0	0.0	300.0	0.0	0	0	0
1024 Fish/Game		300.0										
Legislative add-back appropriation made in Chapter 2, SSSLA2019, of HB2001.												
Reverse the reduction of Fish and Game Fund authority to provide match for Pittman-Robertson funds.												
<b>Special Area Management Reduction</b>												
	Veto	-140.0	0.0	0.0	-140.0	0.0	0.0	0.0	0.0	0	0	0
1004 Gen Fund		-140.0										
General funds are not required for special area management, other sources of funding are available to support these activities. The department is confident a reduction will have little impact to the program or services provided.												
The State's fiscal reality dictates a reduction in expenditures across all agencies.												
<b>Reverse Special Area Management Reduction</b>												
	Inc	140.0	0.0	0.0	140.0	0.0	0.0	0.0	0.0	0	0	0
1004 Gen Fund		140.0										

**Change Record Detail - Multiple Scenarios with Descriptions**  
**Department of Fish and Game**

**Component:** Wildlife Conservation (473)  
**RDU:** Wildlife Conservation (147)

Scenario/Change Record Title	Trans Type	Totals	Personal Services	Travel	Services	Commodities	Capital Outlay	Grants, Benefits	Miscellaneous	Positions		NP
										PFT	PPT	
Legislative add-back appropriation made in Chapter 2, SSSLA2019, of HB2001.												
<b>Special Area Management Reduction</b>												
1004 Gen Fund	Veto	-140.0	0.0	0.0	-140.0	0.0	0.0	0.0	0.0	0	0	0
General funds are not required for special area management, other sources of funding are available to support these activities. The department is confident a reduction will have little impact to the program or services provided.												
The State's fiscal reality dictates a reduction in expenditures across all agencies.												
<b>Executive Branch 50% Travel Reduction</b>												
1002 Fed Rcpts	Veto	-399.7	0.0	-523.8	0.0	0.0	0.0	0.0	0.0	0	0	0
1007 I/A Rcpts		-1.3										
1024 Fish/Game		-116.1										
1108 Stat Desig		-6.7										
State agency travel budgets, not covered under the exemptions of public safety, health, and disaster management, were reduced 50% in the Governor's FY2020 budget. Veto action removes legislative increases to state travel. Agencies will rely on technology and management efficiencies to reduce the amount of state employee travel.												
The State's fiscal reality dictates a reduction in expenditures across all agencies.												
<b>Reverse Executive Branch 50% Travel Reduction</b>												
1002 Fed Rcpts	Inc	399.7	0.0	523.8	0.0	0.0	0.0	0.0	0.0	0	0	0
1007 I/A Rcpts		1.3										
1024 Fish/Game		116.1										
1108 Stat Desig		6.7										
Legislative add-back appropriation made in Chapter 2, SSSLA2019, of HB2001.												
Reverse Executive Branch 50% Travel Reduction.												
<b>Subtotal</b>		<b>49,293.1</b>	<b>29,057.0</b>	<b>1,305.2</b>	<b>14,771.9</b>	<b>3,359.0</b>	<b>0.0</b>	<b>800.0</b>	<b>0.0</b>	<b>223</b>	<b>47</b>	<b>1</b>
***** Changes From FY2020 Authorized To FY2020 Management Plan *****												
<b>Transfer Positions (11-1322, 11-5042 and 11-5201) from Commercial Fisheries for Pittman-Robertson Grant Projects</b>												
	Trin	0.0	0.0	0.0	0.0	0.0	0.0	0.0	0.0	2	1	0
Transfer three positions from the Division of Commercial Fisheries, Westward Region Fisheries Management (11-1322) and Southeast Region Fisheries												

**Change Record Detail - Multiple Scenarios with Descriptions**  
**Department of Fish and Game**

**Component:** Wildlife Conservation (473)  
**RDU:** Wildlife Conservation (147)

Scenario/Change Record Title	Trans Type	Totals	Personal Services	Travel	Services	Commodities	Capital Outlay	Grants, Benefits	Miscellaneous	Positions		NP	
										PFT	PPT		
Management (11-5042 and 11-5201) to Wildlife Conservation to address workload resulting from increased Pittman-Robertson grant projects. The remaining Westward Region Fisheries Management and Southeast Region Fisheries Management staff are sufficient to accommodate the anticipated workload.													
In Wildlife Conservation the positions are: Full-time Wildlife Biologist I (11-1322), range 14, located in Anchorage Full-time Wildlife Biologist II (11-5042), range 16, located in Nome Full-time Training Specialist II (11-5201), range 18, located in Anchorage													
<b>Change Wildlife Biologist I (11-1322) from Part-Time to Full-Time for Workload Adjustment</b>													
	PosAdj	0.0	0.0	0.0	0.0	0.0	0.0	0.0	0.0	0.0	1	-1	0
Change a part-time Wildlife Biologist I (11-1322), range 14, located in Anchorage, to full-time to address workload resulting from increased Pittman-Robertson grant projects.													
<b>Change Natural Resource Specialist I (11-4090) from Part-Time to Full-Time for Workload Adjustment</b>													
	PosAdj	0.0	0.0	0.0	0.0	0.0	0.0	0.0	0.0	0.0	1	-1	0
Change a part-time Natural Resource Specialist I (11-4090), range 14, located in Anchorage, to full-time to address an increased workload in the Southcentral region.													
<b>Align Authority for Pittman-Robertson Match</b>													
	LIT	0.0	750.0	0.0	0.0	0.0	50.0	-800.0	0.0	0.0	0	0	0
Transfer authority from grants to personal services and capital outlay to align Pittman-Robertson state match funding with anticipated Pittman-Robertson expenditures. Pittman-Robertson funding covers personnel, charter flights, and equipment.													
<b>Subtotal</b>		<b>49,293.1</b>	<b>29,807.0</b>	<b>1,305.2</b>	<b>14,771.9</b>	<b>3,359.0</b>	<b>50.0</b>	<b>0.0</b>	<b>0.0</b>	<b>0.0</b>	<b>227</b>	<b>46</b>	<b>1</b>
***** <b>Changes From FY2020 Management Plan To FY2021 Governor</b> *****													
<b>FY2021 Salary and Health Insurance Increases</b>													
	SalAdj	138.0	138.0	0.0	0.0	0.0	0.0	0.0	0.0	0.0	0	0	0
1002 Fed Rcpts		88.5											
1004 Gen Fund		4.6											
1007 I/A Rcpts		2.6											
1024 Fish/Game		36.0											
1061 CIP Rcpts		5.5											
1108 Stat Desig		0.8											
FY2021 GGU Salary Increases: \$123.3													
FY2021 increase to GGU Health Insurance from \$1530 to \$1555 per member per month: \$14.7													



**Change Record Detail - Multiple Scenarios with Descriptions**  
**Department of Fish and Game**

**Component:** Wildlife Conservation (473)  
**RDU:** Wildlife Conservation (147)

Scenario/Change Record Title	Trans Type	Totals	Personal Services	Travel	Services	Commodities	Capital Outlay	Grants, Benefits	Miscellaneous	Positions		NP
										PFT	PPT	
<b>Replace Funding Source for Programmatic Shift</b>												
	FndChg	0.0	0.0	0.0	0.0	0.0	0.0	0.0	0.0	0	0	0
1004 Gen Fund		-9.0										
1024 Fish/Game		9.0										
Change some activities funded by general fund to fish and game fund.												
<b>Change Wildlife Biologist II (11-4197) from Part-Time to Full-Time for Research and Management Programs</b>												
	PosAdj	0.0	0.0	0.0	0.0	0.0	0.0	0.0	0.0	1	-1	0
Change a part-time Wildlife Biologist II (11-4197), range 16, located in Kotzebue to full-time to assume responsibility for current and anticipated research and management programs.												
<b>Add Accounting Technician II (11-N20017) to Assist with Accounting Structures</b>												
	PosAdj	0.0	0.0	0.0	0.0	0.0	0.0	0.0	0.0	0	0	1
Add a non-permanent Accounting Technician II (11-N20017), range 14, located in Juneau, expiring 06/30/2022, to assist with accounting structures and grant tracking work resulting from the large increase in volume of federal Pittman-Robertson grant activity.												
<b>Align Authority with Anticipated Expenditures</b>												
	LIT	0.0	0.0	0.0	0.0	-30.0	30.0	0.0	0.0	0	0	0
Transfer authority from commodities to cover anticipated capital outlay costs based on prior year expenditures. The remaining commodities authority is sufficient to cover anticipated expenditures.												
<b>Totals</b>		<b>49,431.1</b>	<b>29,945.0</b>	<b>1,305.2</b>	<b>14,771.9</b>	<b>3,329.0</b>	<b>80.0</b>	<b>0.0</b>	<b>0.0</b>	<b>228</b>	<b>45</b>	<b>2</b>

**Line Item Detail (1676)**  
**Department of Fish and Game**  
**Travel**

**Component:** Wildlife Conservation (473)

Line Number	Line Name		FY2019 Actuals	FY2020 Management Plan	FY2021 Governor
2000	Travel		1,055.6	1,305.2	1,305.2
Object Class	Servicing Agency	Explanation	FY2019 Actuals	FY2020 Management Plan	FY2021 Governor
<b>2000 Travel Detail Totals</b>			<b>1,055.6</b>	<b>1,305.2</b>	<b>1,305.2</b>
2001	In-State Non-Employee Travel	In-state non-employee travel including transportation and lodging	866.2	1,071.0	1,071.0
2002	Out of State Employee Travel	Out-of-state employee travel including transportation and lodging	105.5	130.4	130.4
2003	Out of State Non-Employee Travel	Out-of-state non-employee travel including transportation and lodging	6.2	7.7	7.7
2005	Moving Costs	Move costs including transferring household goods, transportation and lodging	76.9	95.1	95.1
2006	Other Travel Costs	Other travel fees including cash advances	0.8	1.0	1.0

**Line Item Detail (1676)**  
**Department of Fish and Game**  
**Services**

**Component:** Wildlife Conservation (473)

<b>Line Number</b>	<b>Line Name</b>		<b>FY2019 Actuals</b>	<b>FY2020 Management Plan</b>	<b>FY2021 Governor</b>
3000	Services		14,336.8	14,771.9	14,771.9
<b>Object Class</b>	<b>Servicing Agency</b>	<b>Explanation</b>	<b>FY2019 Actuals</b>	<b>FY2020 Management Plan</b>	<b>FY2021 Governor</b>
<b>3000 Services Detail Totals</b>			<b>14,336.8</b>	<b>14,771.9</b>	<b>14,771.9</b>
3000	Education Services	Training/conference fees and memberships	176.3	186.6	186.6
3001	Financial Services	Management/consulting services and interest expenses HB39 - Bankcard Service Fees Reimbursed	6.2	6.6	6.6
3003	Information Technology	Information technology training and consulting services and software licensing and maintenance	145.9	154.4	154.4
3004	Telecommunications	Television, long distance, data/network and cell phone services	391.4	414.2	414.2
3005	Health Services	Physical exams and medical procedures for pilots and field employees, as well as veterinarian medical procedures	21.5	22.8	22.8
3006	Delivery Services	Freight and postage	257.1	272.1	272.1
3007	Advertising and Promotions	Classified newspaper, radio, and television advertisements	16.3	17.2	17.2
3008	Utilities	Electric, water, sewage, disposal and heating services	221.1	234.0	234.0
3009	Structure/Infrastructure/Land	Appraisal, architect, engineer services and structure/land maintenance and rentals	296.4	313.7	313.7
3010	Equipment/Machinery	Equipment rental, maintenance services and equipment operator charges	335.9	355.0	355.0

**Line Item Detail (1676)**  
**Department of Fish and Game**  
**Services**

**Component:** Wildlife Conservation (473)

Object Class		Servicing Agency	Explanation	FY2019 Actuals	FY2020 Management Plan	FY2021 Governor
<b>3000 Services Detail Totals</b>				<b>14,336.8</b>	<b>14,771.9</b>	<b>14,771.9</b>
3011	Other Services		Wildlife contracts with various organizations to conduct wildlife management activities, charters, print/copy/graphics, commission sales and future contracts and Reimbursable Service Agreement to be determined for various wildlife management activities.	5,063.9	5,738.6	5,738.6
3012	Inter-Agency Federal Indirect Rate Allocation	FishGm - Administrative Services (479)	Federal Indirect paid to Division of Admin Service via SB250 Reimbursable Service Agreement	3,974.7	4,134.3	4,134.3
3015	Inter-Agency Conservation/Environmental	FishGm - Administrative Services (479)	Licensing admin, data entry, ACCT SB250 Reimbursable Service Agreement	361.3	382.3	382.3
3015	Inter-Agency Conservation/Environmental	FishGm - Advisory Committees (2231)	Advisory Committee Board based regulatory process support Reimbursable Service Agreement	49.7	0.0	0.0
3015	Inter-Agency Conservation/Environmental	FishGm - Habitat (486)	Resource development coordination response Reimbursable Service Agreement	22.2	25.0	25.0
3015	Inter-Agency Conservation/Environmental	FishGm - Sport Fisheries (464)	Arlis bibliography project, arlis support services and digital preservation of Alaska National Interest Lands Act Reimbursable Service Agreement	147.4	176.0	176.0
3015	Inter-Agency Conservation/Environmental	FishGm - State Subsistence Research (2625)	Subsistence harvest in northwest Alaska Reimbursable Service Agreement	24.8	0.0	0.0
3015	Inter-Agency Conservation/Environmental	NatRes - Department-wide	Grouse habitat manipulation - Delta Junction, Palmer hay flat state game refuge, Homer airport display RSAs	64.1	68.1	68.1
3015	Inter-Agency Conservation/Environmental	Trans - Department-wide	Northern Region facilities support to F&G Glennallen shared office Reimbursable Services Agreement	0.7	2.0	2.0

**Line Item Detail (1676)**  
**Department of Fish and Game**  
**Services**

**Component:** Wildlife Conservation (473)

Object Class		Servicing Agency	Explanation	FY2019 Actuals	FY2020 Management Plan	FY2021 Governor
<b>3000 Services Detail Totals</b>				<b>14,336.8</b>	<b>14,771.9</b>	<b>14,771.9</b>
3015	Inter-Agency Conservation/Environmental	Univ - Department-wide	Wolf stable isotope analysis and samples, ice seal mercury analyses, Aleutian tern migration analysis, black bear isotope analysis, contaminants concentration in young steller sea lion fur, and pinniped steller sea lion contaminants UAF and UAA Reimbursable Service Agreements	56.3	59.6	59.6
3017	Inter-Agency Information Technology Non-Telecommunications	Admin - Department-wide	Computer Services	463.5	509.9	509.9
3018	Inter-Agency Information Technology Telecommunications	Admin - Department-wide	Telecommunications Services Phones	219.5	241.5	241.5
3020	Inter-Agency Building Maintenance	Trans - Department-wide	Miscellaneous building maintenance cost	5.0	5.3	5.3
3021	Inter-Agency Mail	Admin - Department-wide	Centralized mail services chargeback	15.2	16.7	16.7
3023	Inter-Agency Building Leases	Admin - Department-wide	Leases	295.6	720.0	720.0
3024	Inter-Agency Legal	Law - Department-wide	Alaska management of game, regulations review and endangered species act response RSAs	185.2	235.4	235.4
3026	Inter-Agency Insurance	Admin - Department-wide	Risk management, and property insurance	101.3	111.4	111.4
3027	Inter-Agency Financial	Admin - Department-wide	State payroll (HRM) and accounting (IRIS & ALDER) systems chargeback	41.1	45.2	45.2
3028	Inter-Agency Americans with Disabilities Act Compliance	Admin - Department-wide	Americans with Disabilities Act (ADA) chargeback	1.9	2.1	2.1
3029	Inter-Agency Education/Training	Admin - Department-wide	Education and training	2.8	3.0	3.0
3037	State Equipment Fleet	Trans - Department-wide	State Equipment Fleet	308.0	318.9	318.9
7001	Grants		Various cooperative agreements with regents of the University of Idaho,	464.4	0.0	0.0

**Line Item Detail (1676)**  
**Department of Fish and Game**  
**Services**

**Component:** Wildlife Conservation (473)

Object Class	Servicing Agency	Explanation	FY2019 Actuals	FY2020 Management Plan	FY2021 Governor
<b>3000 Services Detail Totals</b>			<b>14,336.8</b>	<b>14,771.9</b>	<b>14,771.9</b>
7003	Sub-Recipient Pass-Through Grants	University of Montana, University of Washington, Florida Atlantic University, National Audubon Society Inc, Oregon State University, Trent University, the governors of the University of Alberta, Colorado Mesa University, Regents of the University of Idaho, Wildlife Conservation Society, University of Kansas and The Peregrine Fund Inc.  Various University of Anchorage, University of Alaska Southeast and University of Fairbanks Reimbursable Service Agreements	600.1	0.0	0.0

**Line Item Detail (1676)**  
**Department of Fish and Game**  
**Commodities**

**Component:** Wildlife Conservation (473)

<b>Line Number</b>	<b>Line Name</b>		<b>FY2019 Actuals</b>	<b>FY2020 Management Plan</b>	<b>FY2021 Governor</b>
4000	Commodities		3,055.9	3,359.0	3,329.0
<b>Object Class</b>	<b>Servicing Agency</b>	<b>Explanation</b>	<b>FY2019 Actuals</b>	<b>FY2020 Management Plan</b>	<b>FY2021 Governor</b>
<b>4000 Commodities Detail Totals</b>			<b>3,055.9</b>	<b>3,359.0</b>	<b>3,329.0</b>
4000	Business	Books, furniture, tools, business supplies and information technology equipment <\$5,000	844.4	973.0	973.0
4001	Agricultural	Agricultural supplies and Alaska farmers cooperative	73.1	80.4	80.4
4002	Household/Institutional	Landscaping, food, and cleaning supplies	217.4	238.0	238.0
4003	Scientific and Medical	Instruments, lab and non-lab supplies (Scientific and Medical)	1,147.2	1,230.0	1,200.0
4004	Safety	Firearms, ammunition, and other safety supplies	228.3	250.9	250.9
4005	Building Materials	Screws, lumber, nuts, bolts, and other building materials	22.3	24.5	24.5
4006	Signs and Markers	Signs and marker supplies	14.0	15.4	15.4
4008	Aggregate	Aggregate Materials	0.2	0.3	0.3
4011	Electrical	Key-card readers, bulbs, batteries, and other electrical supplies	0.7	0.8	0.8
4012	Plumbing	Heaters, faucets, tubing, and other plumbing supplies	0.5	0.6	0.6
4013	Lube Oils/Grease/Solvents	Marine and motor oil, fuel stabilizer, and other lube oils, grease and solvents	3.7	4.1	4.1
4014	Bottled Gas	Propane, oxygen, and other bottled gases	7.1	7.8	7.8
4015	Parts and Supplies	Parts and supplies	151.0	158.9	158.9

**Line Item Detail (1676)**  
**Department of Fish and Game**  
**Commodities**

**Component:** Wildlife Conservation (473)

Object Class	Servicing Agency	Explanation	FY2019 Actuals	FY2020 Management Plan	FY2021 Governor
<b>4000 Commodities Detail Totals</b>			<b>3,055.9</b>	<b>3,359.0</b>	<b>3,329.0</b>
4016	Paint/Preservatives	Paint and preservatives	2.9	3.2	3.2
4017	Sand	Sand Supplies	1.1	1.2	1.2
4018	Surface Chemicals	Surface Chemicals	0.1	0.2	0.2
4019	Small Tools/Minor Equipment	Flat sockets, drill bits, hooks, hammers, and other small tools	82.9	85.0	85.0
4020	Equipment Fuel	Equipment fuel	259.0	284.7	284.7



**Line Item Detail (1676)**  
**Department of Fish and Game**  
**Capital Outlay**

**Component:** Wildlife Conservation (473)

Line Number	Line Name		FY2019 Actuals	FY2020 Management Plan	FY2021 Governor
5000	Capital Outlay		279.6	50.0	80.0
Object Class	Servicing Agency	Explanation	FY2019 Actuals	FY2020 Management Plan	FY2021 Governor
<b>5000 Capital Outlay Detail Totals</b>			<b>279.6</b>	<b>50.0</b>	<b>80.0</b>
5002	Structures and Infrastructure	Structures and infrastructure supplies	71.3	25.0	25.0
5004	Equipment	Automobile and marine equipment	208.3	25.0	55.0

**Revenue Detail (1681)**  
**Department of Fish and Game**

**Component:** Wildlife Conservation (473)

Revenue Type (OMB Fund Code) Revenue Source	Component	Comment	FY2019 Actuals	FY2020 Management Plan	FY2021 Governor
<b>5002 Fed Rcpts (1002 Fed Rcpts)</b>			<b>30,966.5</b>	<b>32,695.1</b>	<b>32,783.6</b>
5003 Federal - Indirect Recovery		SB250 Federal Indirect paid to Alaska Department of Fish and Game Division of Administrative Services	3,970.0	4,191.6	4,376.9
5010 Federal Natural Resources - Miscellaneous Grants		U.S. Fish and Wildlife Service Grants	24,330.0	25,688.0	25,583.4
5010 Federal Natural Resources - Miscellaneous Grants		US Forest Service Grants	67.5	71.3	71.4
5010 Federal Natural Resources - Miscellaneous Grants		National Oceanic and Atmospheric Administration and National Marine Fisheries Service Grants	1,688.5	1,782.8	1,787.6
5010 Federal Natural Resources - Miscellaneous Grants		Office of Naval Research Grants	454.9	480.3	481.6
5010 Federal Natural Resources - Miscellaneous Grants		Bureau of Land Management Grants	47.1	49.7	49.9
5010 Federal Natural Resources - Miscellaneous Grants		Bureau of Safety and Environmental Enforcement	363.3	383.6	384.7
5010 Federal Natural Resources - Miscellaneous Grants		United States Geological Survey Grants	41.7	44.0	44.1
5010 Federal Natural Resources - Miscellaneous Grants		National Park Service Grants	0.5	0.6	0.6
5021 Federal - Other Prior Year Reimbursement Recovery		Other prior year reimbursement recovery from federal projects	1.5	1.6	1.7
5022 Federal - Charges for Services Prior Year Reimbrsmnt Recovry		Charges for services prior year reimbursement recovery	1.5	1.6	1.7
<b>5007 I/A Rcpts (1007 I/A Rcpts)</b>			<b>423.9</b>	<b>561.5</b>	<b>564.1</b>
5301 Inter-Agency Receipts	Trans - Department-wide	Fairbanks Bird Management Project and Starrigavan Pittman Robertson Project Reimbursable Service Agreements	24.5	83.8	87.4
5301 Inter-Agency Receipts	FishGm - Statewide Fisheries Management (2171)	Access and State's Rights Program, Assert and Protect State's Rights and Subsistence Liaison Services Reimbursable Service Agreements	130.9	184.3	184.7

**Revenue Detail (1681)**  
**Department of Fish and Game**

**Component:** Wildlife Conservation (473)

<b>Revenue Type (OMB Fund Code)</b> <b>Revenue Source</b>	<b>Component</b>	<b>Comment</b>	<b>FY2019 Actuals</b>	<b>FY2020 Management Plan</b>	<b>FY2021 Governor</b>
5301 Inter-Agency Receipts	EnvCon - Department-wide	Rabies Testing Project and Rabies Surveillance Reimbursable Service Agreement	5.6	6.0	6.0
5301 Inter-Agency Receipts	NatRes - Department-wide	Kensington Gold Mine Project Reimbursable Service Agreement	32.8	40.0	40.0
5301 Inter-Agency Receipts	FishGm - EVOS Trustee Council (2693)	Exxon Valdez Oil Spill Trustee Council Trust Agency Support Reimbursable Service Agreement	3.4	7.6	6.2
5301 Inter-Agency Receipts	FishGm - Sport Fisheries (464)	Access and Defense, Access and State's Rights Program and Assert and Protect State's Rights Reimbursable Service Agreement	226.7	239.8	239.8
<b>5061 CIP Rcpts (1061 CIP Rcpts)</b>			<b>1,153.0</b>	<b>933.7</b>	<b>939.2</b>
5351 Capital Improvement Project Inter-Agency		Funds represent the salary costs for division employees who work on the departments Capital Improvement, facility maintenance and repair projects.	1,153.0	933.7	939.2
<b>5108 Stat Desig (1108 Stat Desig)</b>			<b>195.4</b>	<b>516.2</b>	<b>517.0</b>
5201 Statutory Dsgntd Prgrm Rcpts Pblc Prtctn - Permits and Fees		Permits and fees	3.8	4.1	4.2
5206 Statutory Designated Program Receipts - Contracts		Various agreements with Non-governmental Agencies: Conoco Phillips, National Science Board, Annenberg Foundation, Alaska Sea Life Center Foundation, Georgia Aquarium, National Fish and Wildlife Foundation and North Pacific Research Board	176.3	496.0	496.6
5207 Statutory Dsgntd Prgrm Rcpts Chrsgs for Srvcs - Rent/Royalties		Rent and royalties	15.3	16.1	16.2

**Inter-Agency Services (1682)**  
**Department of Fish and Game**

**Component:** Wildlife Conservation (473)

				FY2019 Actuals	FY2020 Management Plan	FY2021 Governor
<b>Component Totals</b>				<b>6,340.3</b>	<b>7,056.7</b>	<b>7,056.7</b>
With Department of Fish and Game				4,580.1	4,717.6	4,717.6
With Department of Natural Resources				64.1	68.1	68.1
With Department of Transportation/Public Facilities				313.7	326.2	326.2
With University of Alaska				56.3	59.6	59.6
With Department of Administration				1,140.9	1,649.8	1,649.8
With Department of Law				185.2	235.4	235.4
<b>Object Class</b>	<b>Servicing Agency</b>	<b>Explanation</b>	<b>FY2019 Actuals</b>	<b>FY2020 Management Plan</b>	<b>FY2021 Governor</b>	
3012	Inter-Agency Federal Indirect Rate Allocation	FishGm - Administrative Services (479)	3,974.7	4,134.3	4,134.3	
3015	Inter-Agency Conservation/Environmental	FishGm - Administrative Services (479)	361.3	382.3	382.3	
3015	Inter-Agency Conservation/Environmental	FishGm - Advisory Committees (2231)	49.7	0.0	0.0	
3015	Inter-Agency Conservation/Environmental	FishGm - Habitat (486)	22.2	25.0	25.0	
3015	Inter-Agency Conservation/Environmental	FishGm - Sport Fisheries (464)	147.4	176.0	176.0	
3015	Inter-Agency Conservation/Environmental	FishGm - State Subsistence Research (2625)	24.8	0.0	0.0	
3015	Inter-Agency Conservation/Environmental	NatRes - Department-wide	64.1	68.1	68.1	

**Inter-Agency Services (1682)**  
**Department of Fish and Game**

**Component:** Wildlife Conservation (473)

Object Class		Servicing Agency	Explanation	FY2019 Actuals	FY2020 Management Plan	FY2021 Governor
3015	Inter-Agency Conservation/Environmental	Trans - Department-wide	Northern Region facilities support to F&G Glennallen shared office Reimbursable Services Agreement	0.7	2.0	2.0
3015	Inter-Agency Conservation/Environmental	Univ - Department-wide	Wolf stable isotope analysis and samples, ice seal mercury analyses, Aleutian tern migration analysis, black bear isotope analysis, contaminants concentration in young steller sea lion fur, and pinniped steller sea lion contaminants UAF and UAA Reimbursable Service Agreements	56.3	59.6	59.6
3017	Inter-Agency Information Technology Non-Telecommunications	Admin - Department-wide	Computer Services	463.5	509.9	509.9
3018	Inter-Agency Information Technology Telecommunications	Admin - Department-wide	Telecommunications Services Phones	219.5	241.5	241.5
3020	Inter-Agency Building Maintenance	Trans - Department-wide	Miscellaneous building maintenance cost	5.0	5.3	5.3
3021	Inter-Agency Mail	Admin - Department-wide	Centralized mail services chargeback	15.2	16.7	16.7
3023	Inter-Agency Building Leases	Admin - Department-wide	Leases	295.6	720.0	720.0
3024	Inter-Agency Legal	Law - Department-wide	Alaska management of game, regulations review and endangered species act response RSAs	185.2	235.4	235.4
3026	Inter-Agency Insurance	Admin - Department-wide	Risk management, and property insurance	101.3	111.4	111.4
3027	Inter-Agency Financial	Admin - Department-wide	State payroll (HRM) and accounting (IRIS & ALDER) systems chargeback	41.1	45.2	45.2
3028	Inter-Agency Americans with Disabilities Act Compliance	Admin - Department-wide	Americans with Disabilities Act (ADA) chargeback	1.9	2.1	2.1
3029	Inter-Agency Education/Training	Admin - Department-wide	Education and training	2.8	3.0	3.0
3037	State Equipment Fleet	Trans - Department-wide	State Equipment Fleet	308.0	318.9	318.9

**Personal Services Expenditure Detail**  
**Department of Fish and Game**

**Scenario:** FY2021 Governor (16414)  
**Component:** Wildlife Conservation (473)  
**RDU:** Wildlife Conservation (147)

PCN	Job Class Title	Time Status	Retire Code	Barg Unit	Location	Salary Sched	Range / Step	Comp Months	Split / Count	Annual Salaries	COLA	Premium Pay	Annual Benefits	Total Costs	UGF Amount
11-0112	Fish & Wildlife Technician IV	PT	A	GP	Anchorage	200	13D / E	12.0		46,867	631	0	35,011	82,509	0
11-0131	Information Officer II	FT	A	GP	Juneau	99	17O	12.0		86,748	1,168	0	48,814	136,730	0
11-0290	Wildlife Biologist I	FT	A	GP	Fairbanks	203	14C / D	12.0		49,752	670	0	36,009	86,431	0
11-0420	Fish & Game Program Technician	FT	A	GP	Kotzebue	260	12D	7.2	**	42,418	571	0	25,955	68,944	0
11-0452	Fish & Game Program Technician	FT	A	GP	Dillingham	99	12O	12.0		79,944	1,076	0	46,459	127,479	0
11-1152	Wildlife Biologist III	FT	A	GP	Palmer	200	18M	12.0		82,872	1,116	0	47,472	131,460	0
11-1171	Wildlife Biologist I	PT	A	GP	Fairbanks	203	14J	12.0		58,908	830	2,718	40,119	102,575	29,921
11-1201	Nat Res Specii	FT	A	GP	Anchorage	200	18B / C	12.0		62,824	846	0	40,534	104,204	0
11-1322	Wildlife Biologist I	FT	A	GP	Anchorage	200	14A	12.0		44,628	601	0	34,236	79,465	0
11-1387	Wildlife Biologist IV	FT	A	GP	Anchorage	200	20L / M	12.0		91,988	1,238	0	50,627	143,853	50,349
11-1391	Wildlife Biologist III	FT	A	GP	Palmer	200	18J / K	12.0		75,900	1,028	469	45,222	122,619	0
11-1393	Wildlife Biologist III	FT	A	GP	Nome	237	18C / D	12.0		87,537	1,192	1,000	49,433	139,162	0
11-1411	Wildlife Biologist III	FT	A	GP	Fairbanks	203	18M	12.0		85,356	1,149	0	48,332	134,837	0
11-1443	Fish & Game Program Technician	PT	A	GP	Haines	200	12G	1.5	*	6,031	81	0	4,436	10,548	0
11-1445	Fish & Game Program Technician	PT	A	GG	Wrangell	99	12N	2.2	*	0	0	0	0	0	0
11-1518	Fish & Wildlife Technician V	FT	A	GP	Soldotna	200	14A / B	12.0		46,025	620	0	34,720	81,365	0
11-1579	Fish & Game Program Technician	FT	A	GP	Nome	237	12C / D	12.0		58,334	785	0	38,980	98,099	3,757
11-1600	Wildlife Veterinarian	FT	A	GP	Palmer	200	22B / C	12.0		82,164	1,106	0	47,227	130,497	0
11-1615	Fish & Wildlife Technician III	FT	A	GP	Homer	200	11K	3.0	*	12,016	174	0	8,856	21,046	0
11-1659	Wildlife Biologist I	PT	A	GP	Anchorage	200	14K	12.0		59,052	795	0	39,228	99,075	34,676
11-1688	Habitat Biologist III	FT	A	GP	Anchorage	200	18J / K	12.0		76,614	1,031	0	45,306	122,951	0
11-1739	Biometrician III	FT	A	GP	Anchorage	200	20L	12.0		91,740	1,235	0	50,542	143,517	0
11-1938	Wildlife Biologist III	FT	A	GP	Fairbanks	203	18J / K	12.0		79,644	1,072	0	46,355	127,071	44,475
11-2001	Division Director - Px	FT	A	XE	Palmer	N00	27F / J	12.0		124,986	0	0	61,944	186,930	28,040
11-2002	Program Coordinator II	FT	A	SS	Juneau	205	20C / D	12.0		84,304	0	0	48,008	132,312	6,748
11-2003	Fish & Game Coordinator	FT	A	SS	Anchorage	200	22D / E	12.0		92,896	0	0	50,982	143,878	0
11-2006	Administrative Assistant II	FT	A	GP	Juneau	205	14C / D	12.0		50,953	696	770	36,692	89,111	13,367
11-2007	Fish & Game Coordinator	FT	A	SS	Juneau	205	22J / K	12.0		109,473	0	196	56,787	166,456	6,941
11-2008	Wildlife Biologist III	FT	A	SS	Kotzebue	260	18D / E	12.0		114,579	0	579	58,686	173,844	0
11-2010	Wildlife Biologist IV	FT	A	SS	Juneau	205	20A	12.0		76,536	0	177	45,381	122,094	0
11-2011	Research Analyst III	FT	A	GP	Anchorage	200	18K / L	12.0		78,053	1,051	0	45,804	124,908	7,295
11-2013	Wildlife Biologist III	FT	A	SS	Fairbanks	99	18O	12.0		94,416	0	331	51,622	146,369	0
11-2014	Wildlife Biologist III	FT	A	SS	Soldotna	200	18A	12.0		63,852	0	176	40,990	105,018	0
11-2015	Wildlife Biologist III	FT	A	GP	Utqiagvik	250	18D / E	12.0		98,541	1,326	0	52,895	152,762	0

Note: If a position is split, an asterisk (\*) will appear in the Split/Count column. If the split position is also counted in the component, two asterisks (\*\*) will appear in this column. [No valid job title] appearing in the Job Class Title indicates that the PCN has an invalid class code or invalid range for the class code effective date of this scenario.

**Personal Services Expenditure Detail**  
**Department of Fish and Game**

**Scenario:** FY2021 Governor (16414)  
**Component:** Wildlife Conservation (473)  
**RDU:** Wildlife Conservation (147)

PCN	Job Class Title	Time Status	Retire Code	Barg Unit	Location	Salary Sched	Range / Step	Comp Months	Split / Count	Annual Salaries	COLA	Premium Pay	Annual Benefits	Total Costs	UGF Amount
11-2016	Wildlife Biologist III	FT	A	SS	Juneau	205	18B / C	12.0		71,628	0	132	43,666	115,426	0
11-2018	Administrative Officer I	FT	A	SS	Anchorage	200	17J / K	12.0		74,889	0	0	44,749	119,638	5,982
11-2020	Wildlife Biologist II	FT	A	GP	Anchorage	200	16F / G	12.0		62,384	840	43	40,396	103,663	0
11-2023	Fish & Wildlife Technician III	PT	A	GP	Anchorage	200	11A	4.5		13,910	187	0	11,861	25,958	0
11-2024	Wildlife Biologist III	FT	A	SS	Cordova	99	18N	12.0		98,544	0	702	53,179	152,425	0
11-2025	Fish & Game Coordinator	FT	A	SS	Nome	237	22J / K	12.0		141,894	0	1,238	67,980	211,112	0
11-2026	Wildlife Biologist III	FT	A	SS	Palmer	200	18K / L	12.0		82,299	0	689	47,552	130,540	0
11-2028	Wildlife Biologist IV	FT	A	SS	Sitka	205	20F	12.0		90,720	0	118	50,269	141,107	0
11-2029	Education Associate II	FT	A	GP	Anchorage	200	15B / C	12.0		50,524	680	0	36,277	87,481	0
11-2031	Wildlife Biologist IV	FT	A	SS	Fairbanks	203	20C	12.0		80,340	0	0	46,636	126,976	0
11-2032	Fish & Game Coordinator	FT	A	SS	Fairbanks	203	22E / F	12.0		100,929	0	0	53,762	154,691	6,188
11-2033	Wildlife Biologist III	FT	A	GP	Delta Junction	200	18D / E	12.0		65,604	883	0	41,496	107,983	0
11-2034	Wildlife Physiologist II	FT	A	GP	Anchorage	99	19P	12.0		97,488	1,320	550	52,721	152,079	0
11-2035	Fish & Game Coordinator	FT	A	SS	Fairbanks	203	22K / L	12.0		108,677	0	0	56,443	165,120	0
11-2036	Wildlife Physiologist II	FT	A	GP	Palmer	99	19R / S	12.0		107,023	1,441	0	55,831	164,295	0
11-2038	Wildlife Biologist III	FT	A	SS	Mcgrath	237	18J / K	12.0		107,318	0	540	56,160	164,018	0
11-2039	Wildlife Biologist III	FT	A	SS	Glennallen	200	18D	12.0		70,704	0	300	43,405	114,409	0
11-2041	Administrative Officer I	FT	A	SS	Anchorage	200	17F	12.0		70,704	0	0	43,301	114,005	57,003
11-2042	Wildlife Biologist III	FT	A	SS	Anchorage	200	18C	12.0		68,304	0	0	42,470	110,774	0
11-2043	Administrative Assistant III	FT	A	GP	Nome	237	15C / D	12.0		71,222	981	1,620	44,001	117,824	0
11-2044	Wildlife Biologist IV	FT	A	GP	Fairbanks	99	20N	12.0		100,740	1,356	0	53,656	155,752	0
11-2045	Wildlife Biologist III	FT	A	SS	Fairbanks	203	18K / L	12.0		83,312	0	300	47,768	131,380	0
11-2049	Division Operations Manager	FT	A	SS	Juneau	205	24K	12.0		126,480	0	0	62,605	189,085	14,181
11-2050	Wildlife Biologist III	FT	A	GP	Fairbanks	203	18G	12.0		74,496	1,006	270	44,667	120,439	0
11-2052	Wildlife Biologist III	FT	A	GP	Fairbanks	203	18F / G	12.0		72,873	984	260	44,102	118,219	0
11-2053	Administrative Assistant II	FT	A	GP	Anchorage	200	14D / E	12.0		50,228	689	951	36,503	88,371	4,419
11-2055	Administrative Assistant II	FT	A	GP	Anchorage	200	14C / D	12.0		49,118	674	917	36,107	86,816	43,408
11-2056	Wildlife Biologist II	FT	A	SS	Anchorage	200	16D / E	12.0		63,104	0	0	40,671	103,775	0
11-2059	Wildlife Biologist II	FT	A	GP	Palmer	200	16B / C	12.0		53,326	719	100	37,281	91,426	0
11-2060	Wildlife Biologist II	FT	A	GP	Palmer	200	16J / K	12.0		66,147	898	600	41,891	109,536	0
11-2061	Wildlife Biologist III	FT	A	GP	Kotzebue	260	18G	12.0		115,716	1,566	650	59,065	176,997	0
11-2062	Analyst/Programmer IV	FT	A	GP	Anchorage	99	20P	12.0		104,256	1,403	0	54,873	160,532	0
11-2063	Fish & Wildlife Technician III	FT	A	GP	Palmer	200	11B / C	12.0		39,264	557	2,112	33,111	75,044	0
11-2064	Administrative Assistant II	FT	A	GP	Fairbanks	203	14K / L	12.0		62,632	859	1,169	40,872	105,532	5,277
11-2066	Wildlife Biologist III	FT	A	SS	Bethel	250	18J	12.0		117,180	0	650	59,611	177,441	0
11-2067	Wildlife Biologist III	FT	A	SS	King Salmon	99	18P	12.0		141,972	0	950	67,920	210,842	0
11-2068	Wildlife Biologist II	FT	A	GP	Nome	237	16B / C	12.0		74,028	1,011	1,050	44,775	120,864	0

Note: If a position is split, an asterisk (\*) will appear in the Split/Count column. If the split position is also counted in the component, two asterisks (\*\*) will appear in this column. [No valid job title] appearing in the Job Class Title indicates that the PCN has an invalid class code or invalid range for the class code effective date of this scenario.

**Personal Services Expenditure Detail**  
**Department of Fish and Game**

**Scenario:** FY2021 Governor (16414)  
**Component:** Wildlife Conservation (473)  
**RDU:** Wildlife Conservation (147)

PCN	Job Class Title	Time Status	Retire Code	Barg Unit	Location	Salary Sched	Range / Step	Comp Months	Split / Count	Annual Salaries	COLA	Premium Pay	Annual Benefits	Total Costs	UGF Amount
11-2069	Wildlife Biologist III	FT	A	SS	Dillingham	237	18B / C	12.0		90,690	0	950	50,547	142,187	0
11-2070	Wildlife Biologist III	FT	A	GP	Fairbanks	203	18J	12.0		77,544	1,044	0	45,628	124,216	0
11-2072	Fish & Game Program Technician	FT	A	GP	Cordova	211	12G	6.0	**	26,478	357	0	18,559	45,394	0
11-2073	Wildlife Biologist III	FT	A	SS	Tok	99	18O	12.0		91,668	0	700	50,799	143,167	0
11-2074	Education Associate II	FT	A	GP	Fairbanks	99	15R	12.0		81,509	1,097	0	47,001	129,607	0
11-2075	Fish & Wildlife Technician V	FT	A	GP	Anchorage	200	14L / M	12.0		61,220	863	2,914	40,987	105,984	0
11-2076	Publications Specialist II	FT	A	GP	Juneau	99	16N	12.0		78,600	1,058	0	45,994	125,652	0
11-2078	Information Officer II	FT	A	GP	Anchorage	200	17A	12.0		54,888	739	0	37,787	93,414	0
11-2081	Publications Specialist II	FT	A	GP	Fairbanks	203	16B / C	12.0		56,386	759	0	38,306	95,451	0
11-2082	Wildlife Veterinarian	FT	A	GP	Fairbanks	99	22M	12.0		111,864	1,506	0	57,506	170,876	1,282
11-2083	Administrative Assistant II	FT	A	GP	Palmer	200	14G	12.0		54,888	753	1,055	38,152	94,848	4,742
11-2084	Office Assistant I	FT	A	GP	Anchorage	200	8B / C	12.0		32,748	441	0	30,124	63,313	0
11-2085	Wildlife Biologist III	FT	A	GP	Fairbanks	203	18M	12.0		85,356	1,158	700	48,574	135,788	0
11-2086	Wildlife Biologist II	FT	A	GP	King Salmon	250	16J	12.0		98,820	1,340	700	53,234	154,094	0
11-2089	Project Assistant	FT	A	GP	Palmer	200	16J / K	12.0		66,948	931	2,226	42,731	112,836	0
11-2090	Wildlife Biologist II	FT	A	GP	Homer	200	16G / J	12.0		65,335	882	200	41,472	107,889	0
11-2091	Fish & Game Coordinator	FT	A	SS	Anchorage	200	22C / D	12.0		90,251	0	300	50,170	140,721	7,036
11-2092	Wildlife Biologist II	FT	A	GP	Glennallen	200	16A	12.0		51,264	698	600	36,740	89,302	0
11-2093	Administrative Officer I	FT	A	SS	Juneau	205	17F / J	12.0		76,355	0	0	45,257	121,612	6,081
11-2097	Wildlife Biologist II	FT	A	SS	Fairbanks	99	16L / M	12.0		75,756	0	0	45,049	120,805	0
11-2098	Wildlife Biologist III	FT	A	SS	Petersburg	200	18F	12.0		75,672	0	200	45,090	120,962	0
11-2099	Wildlife Biologist III	FT	A	SS	Ketchikan	200	18B / C	12.0		67,389	0	200	42,223	109,812	0
11-2100	Wildlife Biologist III	FT	A	GP	Juneau	205	18G	12.0		75,936	1,025	200	45,141	122,302	0
11-2101	Wildlife Biologist III	FT	A	SS	Kodiak	211	18F / J	12.0		86,486	0	400	48,902	135,788	0
11-2102	Wildlife Scientist I	FT	A	SS	Juneau	205	22E / F	12.0		102,885	0	0	54,439	157,324	42,902
11-2104	Wildlife Biologist III	FT	A	GP	Palmer	200	18F / G	12.0		71,862	967	0	43,662	116,491	0
11-2105	Wildlife Biologist III	FT	A	GP	Fairbanks	203	18G / J	12.0		77,036	1,037	0	45,452	123,525	0
11-2106	Accounting Technician I	FT	A	GP	Anchorage	200	12B / C	12.0		41,718	572	778	33,498	76,566	3,828
11-2107	Statistical Technician II	FT	A	GP	Fairbanks	203	14L	12.0		62,796	845	0	40,524	104,165	0
11-2109	Accounting Technician I	FT	A	GP	Fairbanks	203	12G	12.0		49,140	674	945	36,125	86,884	4,344
11-2111	Analyst/Programmer V	FT	A	SS	Anchorage	99	22M	12.0		112,176	0	0	57,654	169,830	0
11-2113	Biometrician I	FT	A	GP	Fairbanks	203	17B / C	12.0		60,828	819	0	39,843	101,490	0
11-2115	Wildlife Biologist IV	FT	A	SS	Fairbanks	99	20O / P	12.0		110,314	0	0	57,010	167,324	13,001
11-2116	Fish & Game Program Technician	FT	A	GP	Glennallen	200	12B / C	6.0	**	20,831	281	0	16,605	37,717	0
11-2117	Fish & Game Program Technician	FT	A	GP	Sitka	205	12B / C	12.0		43,266	582	0	33,765	77,613	0
11-2118	Fish & Game Program	FT	N	GP	King Salmon	250	12A	4.8	**	23,948	270	0	10,536	34,754	0

Note: If a position is split, an asterisk (\*) will appear in the Split/Count column. If the split position is also counted in the component, two asterisks (\*\*) will appear in this column. [No valid job title] appearing in the Job Class Title indicates that the PCN has an invalid class code or invalid range for the class code effective date of this scenario.



**Personal Services Expenditure Detail**  
**Department of Fish and Game**

**Scenario:** FY2021 Governor (16414)  
**Component:** Wildlife Conservation (473)  
**RDU:** Wildlife Conservation (147)

PCN	Job Class Title	Time Status	Retire Code	Barg Unit	Location	Salary Sched	Range / Step	Comp Months	Split / Count	Annual Salaries	COLA	Premium Pay	Annual Benefits	Total Costs	UGF Amount
	Technician														
11-2119	Biometrician III	FT	A	GP	Anchorage	99	20S	12.0		114,983	1,548	0	58,586	175,117	0
11-2121	Wildlife Biologist III	FT	A	SS	Fairbanks	203	18F	12.0		77,940	0	0	45,805	123,745	0
11-2122	Wildlife Biologist III	FT	A	SS	Anchorage	200	18F / J	12.0		76,080	0	0	45,162	121,242	0
11-2123	Asst Dir F&G	FT	A	SS	Palmer	99	22K	12.0		105,228	0	0	55,250	160,478	8,024
11-2125	Wildlife Biologist I	FT	A	GP	Palmer	200	14B / C	12.0		46,607	627	0	34,921	82,155	0
11-2126	Accountant III	FT	A	GP	Juneau	205	18E / F	12.0		71,848	967	0	43,657	116,472	17,471
11-2127	Wildlife Biologist III	FT	A	GP	Douglas	205	18C / D	12.0		66,999	902	0	41,979	109,880	0
11-2128	Project Assistant	FT	A	SS	Anchorage	600	16P	12.0		81,864	0	0	47,163	129,027	0
11-2129	Office Assistant II	FT	A	GP	Fairbanks	203	10C / D	12.0		38,831	523	0	32,230	71,584	3,579
11-2130	Wildlife Biologist III	FT	A	GP	Fairbanks	203	18J	12.0		77,544	1,057	1,000	45,974	125,575	0
11-2131	Project Assistant	FT	A	GP	Juneau	205	16K / L	3.0	*	18,314	304	8,459	13,964	41,041	0
11-2132	Wildlife Biologist III	FT	A	GP	Anchorage	200	18G	12.0		72,324	974	0	43,822	117,120	0
11-2133	Wildlife Biologist III	FT	A	GP	Nome	237	18C / D	12.0		87,045	1,172	0	48,917	137,134	0
11-2134	Analyst/Programmer III	FT	A	GP	Juneau	205	18A / B	12.0		63,660	857	0	40,823	105,340	0
11-2135	Fish & Wildlife Technician IV	PT	A	GP	Delta Junction	200	13D / E	12.0		47,387	638	0	35,191	83,216	0
11-2136	Wildlife Biologist III	FT	A	GP	Fairbanks	203	18J	12.0		77,544	1,044	0	45,628	124,216	0
11-2137	Analyst/Programmer V	FT	A	GP	Fairbanks	203	22A	12.0		79,548	1,071	0	46,322	126,941	0
11-2139	Administrative Officer I	FT	A	SS	Juneau	99	17N	12.0		87,120	0	0	48,983	136,103	20,416
11-2140	Wildlife Biologist II	FT	A	GP	Juneau	205	16C / D	12.0		57,726	777	0	38,769	97,272	0
11-2141	Education Associate III	FT	A	GP	Anchorage	200	17K	12.0		72,696	979	0	43,950	117,625	0
11-2142	Analyst/Programmer III	FT	A	GP	Anchorage	200	18A / B	12.0		59,315	798	0	39,319	99,432	0
11-2144	Fish & Game Program Technician	PT	A	GP	Tok	200	12L / M	11.0		53,216	716	0	27,030	80,962	0
11-2145	Wildlife Biologist I	PT	A	GP	Douglas	205	14G / J	11.0		54,240	766	2,680	36,924	94,610	0
11-2146	Fish & Wildlife Technician IV	PT	A	GP	Anchorage	200	13D	6.0		23,076	339	2,130	18,119	43,664	0
11-2150	Fish & Wildlife Technician IV	PT	A	GP	Anchorage	200	13C / D	12.0		44,755	602	0	34,280	79,637	0
11-2152	Fish & Wildlife Technician III	PT	A	GP	Fairbanks	203	11J	12.0		47,880	658	1,002	35,708	85,248	0
11-2153	Analyst/Programmer IV	FT	A	GP	Juneau	205	20F / G	12.0		85,172	1,147	0	48,268	134,587	0
11-2154	Fish & Wildlife Technician III	PT	A	GP	Tok	100	11K	12.0		48,432	687	2,585	36,447	88,151	0
11-2156	Fish & Wildlife Technician V	FT	A	GP	Juneau	99	14O	12.0		70,464	995	3,454	44,373	119,286	0
11-2157	Wildlife Biologist III	FT	A	GP	Fairbanks	203	18K / L	12.0		81,263	1,094	0	46,915	129,272	39,712
11-2160	Fish & Wildlife Technician III	PT	A	GP	Fairbanks	203	11L	12.0		51,048	712	1,870	37,105	90,735	0
11-2161	Accounting Technician I	FT	A	GP	Juneau	205	12J	12.0		52,212	716	1,004	37,208	91,140	4,557
11-2162	Wildlife Biologist III	FT	A	GP	Juneau	205	18K / L	12.0		84,166	1,136	200	47,989	133,491	0
11-2163	Office Assistant IV	FT	A	SS	Anchorage	99	12P / Q	12.0		62,569	0	1,127	40,875	104,571	0
11-2164	Fish & Wildlife Technician IV	PT	A	GP	Juneau	205	13L	7.8		38,852	523	0	25,660	65,035	1,203
11-2166	Analyst/Programmer IV	FT	A	GP	Palmer	200	20M	12.0		94,716	1,275	0	51,572	147,563	0

Note: If a position is split, an asterisk (\*) will appear in the Split/Count column. If the split position is also counted in the component, two asterisks (\*\*) will appear in this column. [No valid job title] appearing in the Job Class Title indicates that the PCN has an invalid class code or invalid range for the class code effective date of this scenario.

**Personal Services Expenditure Detail**  
**Department of Fish and Game**

**Scenario:** FY2021 Governor (16414)  
**Component:** Wildlife Conservation (473)  
**RDU:** Wildlife Conservation (147)

PCN	Job Class Title	Time Status	Retire Code	Barg Unit	Location	Salary Sched	Range / Step	Comp Months	Split / Count	Annual Salaries	COLA	Premium Pay	Annual Benefits	Total Costs	UGF Amount
11-2168	Program Coordinator II	FT	A	SS	Palmer	200	20F / J	12.0		87,102	0	0	48,976	136,078	0
11-2169	Wildlife Biologist II	PT	A	GP	Soldotna	200	16J	11.0		60,390	813	0	38,125	99,328	0
11-2174	Asst Dir F&G	FT	A	SS	Juneau	205	22J / K	12.0		110,195	0	0	56,969	167,164	8,358
11-2177	Fish & Wildlife Technician IV	FT	A	GP	Anchorage	200	13G / J	12.0		51,887	730	2,366	37,567	92,550	0
11-2178	Wildlife Biologist II	FT	A	GP	Mcgrath	237	16C / D	12.0		75,664	1,023	339	45,095	122,121	0
11-2179	Wildlife Biologist III	FT	A	GP	Anchorage	200	18F / G	12.0		70,289	946	0	43,117	114,352	40,023
11-2182	Wildlife Biologist IV	FT	A	SS	Soldotna	200	20P	12.0		108,096	0	0	56,242	164,338	0
11-2183	Wildlife Biologist IV	FT	A	SS	Bethel	250	20L / M	12.0		143,660	0	900	68,387	212,947	0
11-2184	Wildlife Biologist III	FT	A	SS	Anchorage	200	18E / F	12.0		74,396	0	400	44,717	119,513	0
11-2186	Wildlife Biologist IV	FT	A	SS	Juneau	205	20C	12.0		81,900	0	150	47,228	129,278	0
11-2187	Admn OPS Mgr I	FT	A	SS	Juneau	205	22E / F	12.0		100,642	0	0	53,662	154,304	23,146
11-2188	Fish & Wildlife Technician III	PT	A	GP	Fairbanks	203	11E / F	8.5		31,349	422	0	24,160	55,931	0
11-2190	Fish & Game Program Technician	FT	A	GP	Juneau	205	12J / K	12.0		53,703	733	750	37,637	92,823	0
11-2195	Statistical Technician I	FT	A	GP	Anchorage	200	12G	12.0		47,712	642	0	35,303	83,657	0
11-2196	Fish & Wildlife Technician III	PT	A	GP	Anchorage	200	11G	10.0		37,190	501	0	28,530	66,221	0
11-2197	Wildlife Physiologist II	FT	A	SS	Soldotna	99	19M / N	12.0		93,279	0	500	51,287	145,066	0
11-2201	Program Coordinator II	FT	A	SS	Anchorage	200	20F / J	12.0		87,102	0	0	48,976	136,078	0
11-2202	Fish & Wildlife Technician III	PT	A	GP	Mcgrath	237	11G	9.0		45,855	640	1,710	30,555	78,760	0
11-2203	Gis Analyst III	FT	A	GP	Anchorage	200	19E / F	12.0		74,405	1,002	0	44,542	119,949	0
11-2204	Fish & Game Coordinator	FT	A	SS	Anchorage	99	22M / N	12.0		115,531	0	0	58,816	174,347	0
11-2205	Analyst/Programmer IV	FT	A	GP	Anchorage	200	20L / M	12.0		91,864	1,237	0	50,584	143,685	0
11-2206	Biometrician III	FT	A	GP	Fairbanks	203	20C / D	12.0		75,959	1,022	0	45,080	122,061	0
11-2208	Wildlife Biologist III	FT	A	SS	Anchorage	99	18Q	12.0		97,716	0	0	52,650	150,366	0
11-2209	Wildlife Biologist II	FT	A	GP	Fairbanks	99	16P	12.0		82,200	1,107	0	47,240	130,547	0
11-2211	Wildlife Biologist II	FT	A	GP	Juneau	205	16J	12.0		69,180	933	150	42,785	113,048	0
11-2213	Fish & Game Program Technician	FT	A	GP	Anchorage	200	12G	12.0		47,712	642	0	35,303	83,657	0
11-2214	Wildlife Biologist III	FT	A	GP	Anchorage	200	18C / D	12.0		65,334	879	0	41,402	107,615	0
11-2215	Wildlife Biologist III	FT	A	GP	Fairbanks	99	18N	12.0		88,128	1,187	50	49,309	138,674	0
11-2216	Wildlife Biologist IV	FT	A	SS	Palmer	99	20O / P	12.0		105,824	0	0	55,456	161,280	0
11-2217	Analyst/Programmer III	FT	A	GP	Anchorage	200	18A	12.0		59,052	795	0	39,228	99,075	0
11-2218	Habitat Biologist II	FT	A	GP	Palmer	99	16M	12.0		72,504	976	0	43,884	117,364	0
11-2220	Wildlife Physiologist III	FT	A	SS	Juneau	205	21F	12.0		96,876	0	0	52,359	149,235	746
11-2221	Wildlife Biologist III	FT	A	GP	Juneau	205	18O / P	12.0		95,521	1,286	0	51,850	148,657	5,619
11-2222	Education Associate II	FT	A	GP	Juneau	205	15A / B	12.0		51,495	693	0	36,613	88,801	0
11-2223	Fish & Wildlife Technician IV	PT	N	GP	Anchorage	200	13B / C	6.5		23,670	267	0	13,163	37,100	0
11-2224	Wildlife Biologist I	PT	A	GP	Ketchikan	200	14F / G	11.0		49,746	690	1,500	34,961	86,897	0
11-2225	Wildlife Biologist III	FT	A	SS	Nome	237	18C / D	12.0		95,357	0	1,000	52,179	148,536	0

Note: If a position is split, an asterisk (\*) will appear in the Split/Count column. If the split position is also counted in the component, two asterisks (\*\*) will appear in this column. [No valid job title] appearing in the Job Class Title indicates that the PCN has an invalid class code or invalid range for the class code effective date of this scenario.

**Personal Services Expenditure Detail**  
**Department of Fish and Game**

**Scenario:** FY2021 Governor (16414)  
**Component:** Wildlife Conservation (473)  
**RDU:** Wildlife Conservation (147)

PCN	Job Class Title	Time Status	Retire Code	Barg Unit	Location	Salary Sched	Range / Step	Comp Months	Split / Count	Annual Salaries	COLA	Premium Pay	Annual Benefits	Total Costs	UGF Amount
11-2226	Wildlife Biologist II	FT	A	GP	Anchorage	200	16K	12.0		68,016	916	0	42,331	111,263	8,790
11-2227	Wildlife Biologist II	PT	A	GP	Juneau	205	16J / K	11.0		65,182	880	175	39,845	106,082	0
11-2228	Wildlife Biologist III	FT	A	GP	Juneau	99	18M / N	12.0		89,490	1,207	200	49,832	140,729	0
11-2229	Wildlife Biologist IV	FT	A	SS	Palmer	200	20B / C	12.0		76,836	0	325	45,536	122,697	0
11-2230	Administrative Officer I	FT	A	SS	Fairbanks	99	17M	12.0		82,764	0	0	47,475	130,239	6,512
11-2231	Wildlife Biologist II	FT	A	GP	Bethel	250	16C / D	12.0		82,848	1,121	450	47,620	132,039	0
11-2232	Gis Analyst II	FT	A	GP	Homer	200	17G	12.0		67,584	910	0	42,181	110,675	0
11-2233	Analyst/Programmer III	FT	A	GP	Juneau	205	18G	12.0		75,936	1,022	0	45,072	122,030	30,508
11-2234	Wildlife Biologist I	FT	A	GP	Kodiak	99	14N / O	12.0		73,607	1,042	3,832	45,592	124,073	0
11-2235	Natural Resource Manager II	FT	A	SS	Anchorage	200	20B / C	12.0		77,612	0	0	45,692	123,304	0
11-2236	Fish & Wildlife Technician III	PT	A	GP	Palmer	200	11B / C	11.0		35,663	510	2,260	30,350	68,783	0
11-2237	Fish & Wildlife Technician III	PT	A	GP	Anchorage	200	11D / E	10.0		34,689	496	2,167	28,414	65,766	0
11-2238	Wildlife Biologist III	FT	A	GP	Fairbanks	99	18O / P	12.0		93,333	1,267	800	51,370	146,770	0
11-2239	Gis Analyst III	FT	A	GP	Fairbanks	203	19D / E	12.0		74,305	1,004	300	44,611	120,220	0
11-2240	Accounting Technician I	FT	A	GP	Fairbanks	203	12J	12.0		51,216	689	0	36,516	88,421	14,731
11-2242	Wildlife Biologist II	FT	A	GP	Fairbanks	203	16G / J	12.0		67,185	911	500	42,216	110,812	0
11-2243	Fish & Wildlife Technician III	PT	A	GP	Fairbanks	203	11B / C	12.0		40,149	565	1,812	33,313	75,839	0
11-2244	Education Associate III	FT	A	GP	Fairbanks	99	17N / O	12.0		83,424	1,123	0	47,663	132,210	5,513
11-2246	Wildlife Biologist II	FT	A	GP	Fairbanks	203	16C / D	12.0		58,302	792	500	39,142	98,736	0
11-2248	Research Analyst III	FT	A	GP	Juneau	99	18N	12.0		89,844	1,209	0	49,885	140,938	4,115
11-2249	Analyst/Programmer V	FT	A	SS	Juneau	99	22M / N	12.0		119,385	0	0	60,149	179,534	1,041
11-2250	Education Associate II	FT	A	GP	Anchorage	200	15A / B	12.0		49,266	663	0	35,841	85,770	0
11-2252	Wildlife Biologist III	FT	A	GP	Haines	200	18N	12.0		85,560	1,152	0	48,403	135,115	2,648
11-2253	Wildlife Biologist I	PT	A	GP	Juneau	205	14F / G	11.0		51,343	730	2,877	35,990	90,940	0
11-2254	Accounting Technician I	FT	A	GP	Anchorage	200	12C / D	12.0		42,528	583	804	33,788	77,703	38,852
11-2255	Program Coordinator II	FT	A	GP	Anchorage	200	20J	12.0		86,052	1,158	0	48,573	135,783	0
11-2256	Wildlife Biologist III	FT	A	GP	Juneau	205	18L / M	12.0		84,390	1,136	0	47,998	133,524	46,733
11-2257	Fish & Wildlife Technician III	PT	A	GP	Juneau	205	11F / G	11.0		42,361	605	2,589	32,782	78,337	0
11-2258	Gis Analyst II	FT	A	GP	Anchorage	200	17G	12.0		67,584	910	0	42,181	110,675	0
11-2259	Fish & Wildlife Technician III	PT	A	GP	Fairbanks	203	11B	6.0		19,638	264	0	16,192	36,094	0
11-2260	Wildlife Biologist II	PT	A	GP	Fairbanks	203	16K / L	12.0		71,861	967	0	43,661	116,489	0
11-2262	Fish & Wildlife Technician III	PT	A	GP	Juneau	205	11G	3.5		13,668	213	2,162	10,959	27,002	0
11-2263	Wildlife Physiologist II	FT	A	GP	Fairbanks	203	19A	12.0		65,160	877	0	41,342	107,379	0
11-2264	Wildlife Biologist IV	FT	A	SS	Fairbanks	203	20J	12.0		91,884	0	0	50,631	142,515	0
11-2265	Wildlife Biologist IV	FT	A	SS	Anchorage	200	20L	12.0		95,124	0	0	51,753	146,877	9,341
11-2266	Fish & Wildlife Technician II	PT	A	GP	Fairbanks	203	9D / E	12.0		38,104	513	0	31,978	70,595	0
11-2267	Education Associate III	FT	A	GP	Nome	237	17B / C	12.0		80,424	1,083	0	46,625	128,132	5,343
11-2268	Fish & Game Coordinator	FT	A	SS	Anchorage	200	22E / F	12.0		96,848	0	0	52,349	149,197	52,219

Note: If a position is split, an asterisk (\*) will appear in the Split/Count column. If the split position is also counted in the component, two asterisks (\*\*) will appear in this column. [No valid job title] appearing in the Job Class Title indicates that the PCN has an invalid class code or invalid range for the class code effective date of this scenario.

**Personal Services Expenditure Detail**  
**Department of Fish and Game**

**Scenario:** FY2021 Governor (16414)  
**Component:** Wildlife Conservation (473)  
**RDU:** Wildlife Conservation (147)

PCN	Job Class Title	Time Status	Retire Code	Barg Unit	Location	Salary Sched	Range / Step	Comp Months	Split / Count	Annual Salaries	COLA	Premium Pay	Annual Benefits	Total Costs	UGF Amount
11-2269	Wildlife Scientist II	FT	A	SS	Juneau	205	24E / F	12.0		116,217	0	0	59,053	175,270	14,968
11-2270	Budget Analyst II	FT	A	SS	Juneau	205	19F / J	12.0		87,341	0	0	49,059	136,400	20,460
11-2273	Education Associate III	FT	A	GP	Juneau	205	17E / F	12.0		67,755	912	0	42,240	110,907	6,466
11-2274	Wildlife Biologist IV	FT	A	SS	Anchorage	99	20M	12.0		98,220	0	500	52,997	151,717	0
11-2275	Fish & Wildlife Technician III	PT	A	GP	Anchorage	200	11A	3.0		9,272	125	0	5,558	14,955	0
11-2276	Fish & Wildlife Technician IV	PT	A	GP	Tenakee Springs	200	13G / J	5.0		21,627	291	0	11,400	33,318	0
11-2277	Boat Officer II	FT	A	GP	Anchorage	200	15K	10.0		52,878	712	0	33,960	87,550	1,340
11-2278	Program Coordinator II	FT	A	SS	Juneau	99	20L / M	12.0		100,012	0	0	53,444	153,456	12,783
11-2281	Fish & Wildlife Technician III	PT	A	GP	Anchorage	200	11D	4.0		13,488	207	1,867	8,446	24,008	0
11-2282	Fish & Wildlife Technician V	PT	A	GP	Anchorage	200	14J / K	10.3		49,911	707	2,639	34,316	87,573	0
11-2283	Education Associate III	FT	A	GP	Anchorage	200	17C / D	12.0		59,315	798	0	39,319	99,432	6,215
11-2284	Wildlife Biologist II	PT	A	GP	Fairbanks	203	16B / C	12.0		56,240	757	0	38,255	95,252	0
11-2285	Biometrician II	PT	A	GP	Fairbanks	203	19L / M	12.0		90,137	1,213	0	49,987	141,337	9,017
11-2286	Wildlife Biologist II	FT	A	GP	Ketchikan	200	16B / C	12.0		53,397	720	100	37,306	91,523	0
11-2287	Wildlife Biologist III	FT	A	GP	Fairbanks	203	18A	12.0		60,828	819	0	39,843	101,490	0
11-2288	Wildlife Biologist II	FT	A	GP	Tok	200	16F / G	12.0		61,592	834	400	40,246	103,072	0
11-2289	Fish & Game Coordinator	FT	A	SS	Palmer	200	22O	12.0		119,604	0	0	60,225	179,829	8,992
11-2290	Fish & Game Coordinator	FT	A	SS	Palmer	200	22D / E	12.0		95,029	0	150	51,772	146,951	0
11-2291	Administrative Officer I	FT	A	SS	Palmer	200	17D / E	12.0		66,383	0	0	41,805	108,188	5,409
11-2292	Wildlife Biologist III	FT	A	GP	Homer	99	18N	12.0		85,560	1,156	350	48,524	135,590	0
11-2293	Biometrician II	FT	A	GP	Palmer	200	19C / D	12.0		67,689	911	0	42,218	110,818	0
11-2294	Wildlife Biologist II	FT	A	GP	Anchorage	200	16A	12.0		51,264	690	0	36,533	88,487	0
11-2295	Administrative Assistant II	FT	A	GP	Anchorage	200	14C / D	12.0		48,748	656	0	35,662	85,066	42,533
11-4004	Research Analyst III	FT	A	GP	Juneau	205	18J / K	12.0		79,270	1,067	0	46,226	126,563	0
11-4009	Wildlife Biologist I	PT	A	GP	Juneau	205	14D / E	12.0		52,506	707	0	36,963	90,176	31,562
11-4047	Fish & Game Program Technician	FT	A	GP	Soldotna	200	12K / L	6.0	*	26,508	390	2,448	19,417	48,763	0
11-4053	Fish & Game Program Technician	FT	A	GP	Kodiak	211	12E	6.0	*	24,803	335	50	17,997	43,185	0
11-4090	Natural Resource Specialist II	FT	A	GP	Anchorage	200	16J / K	12.0		67,571	910	0	42,177	110,658	0
11-4093	Fish & Wildlife Technician III	PT	A	GP	Fairbanks	203	11D / E	12.0		42,974	578	0	33,664	77,216	0
11-4100	Wildlife Biologist II	PT	A	GP	Palmer	200	16F / G	11.0		57,112	775	470	37,154	95,511	0
11-4117	Wildlife Biologist II	FT	A	GP	Fairbanks	203	16G	12.0		65,160	877	0	41,342	107,379	0
11-4140	Natural Resource Manager III	FT	A	SS	Anchorage	200	22D	12.0		92,268	0	0	50,764	143,032	0
11-4173	Biometrician III	FT	A	GP	Juneau	99	20Q	12.0		113,028	1,521	0	57,909	172,458	27,662
11-4197	Wildlife Biologist II	FT	A	GP	Kotzebue	260	16B / C	12.0		86,681	1,167	0	48,791	136,639	0

Note: If a position is split, an asterisk (\*) will appear in the Split/Count column. If the split position is also counted in the component, two asterisks (\*\*) will appear in this column. [No valid job title] appearing in the Job Class Title indicates that the PCN has an invalid class code or invalid range for the class code effective date of this scenario.

**Personal Services Expenditure Detail**  
**Department of Fish and Game**

**Scenario:** FY2021 Governor (16414)  
**Component:** Wildlife Conservation (473)  
**RDU:** Wildlife Conservation (147)

PCN	Job Class Title	Time Status	Retire Code	Barg Unit	Location	Salary Sched	Range / Step	Comp Months	Split / Count	Annual Salaries	COLA	Premium Pay	Annual Benefits	Total Costs	UGF Amount
11-4201	Fish & Wildlife Technician III	PT	A	GP	Delta Junction	200	11G	3.3	*	12,273	239	0	9,415	21,927	0
11-4209	Wildlife Biologist I	PT	A	GP	Palmer	200	14E / F	10.5		46,056	653	2,466	33,235	82,410	0
11-4227	Wildlife Biologist IV	FT	A	GP	Anchorage	200	20C	12.0		72,324	974	0	43,822	117,120	0
11-4236	Office Assistant III	PT	A	GP	Galena	237	11E / F	4.0		19,396	261	0	9,845	29,502	0
11-4281	Education Associate III	FT	A	GP	Palmer	200	17G	12.0		67,584	910	0	42,181	110,675	7,836
11-4283	Fish & Wildlife Technician III	PT	A	GP	Soldotna	99	11N	11.0		48,433	685	2,440	34,832	86,390	0
11-4319	Analyst/Programmer IV	FT	A	GP	Palmer	200	20E / F	12.0		79,120	1,065	0	46,174	126,359	0
11-4325	Fish & Wildlife Technician III	PT	A	GP	Fairbanks	203	11J	11.0		43,890	591	0	32,415	76,896	0
11-4339	Data Processing Manager I	FT	A	SS	Juneau	99	22L	12.0		114,072	0	0	58,311	172,383	0
11-5019	Biometrician II	FT	A	GP	Juneau	205	19J / K	12.0		85,625	1,153	0	48,425	135,203	0
11-5029	Fish & Game Program Technician	PT	A	GP	Yakutat	200	12D	3.0	*	10,779	149	450	8,584	19,962	0
11-5042	Wildlife Biologist II	FT	A	GP	Nome	237	16A	12.0		70,236	945	0	43,099	114,280	0
11-5050	Fish & Wildlife Technician III	PT	A	GP	Juneau	205	11A	3.0		9,740	131	0	8,069	17,940	6,279
11-5108	Fish & Wildlife Technician IV	PT	A	GP	Soldotna	200	13F / G	11.0		46,400	655	2,284	34,074	83,413	0
11-5119	Biometrician III	FT	A	GP	Fairbanks	99	20N / O	12.0		101,964	1,373	0	54,080	157,417	0
11-5195	Fish & Game Program Technician	FT	A	GP	Petersburg	200	12O	6.0	**	29,534	406	682	19,853	50,475	0
11-5201	Training Specialist II	FT	A	GP	Anchorage	200	18C	12.0		63,264	852	0	40,686	104,802	0
11-6007	Gis Analyst III	FT	A	GP	Anchorage	200	19F / G	12.0		75,617	1,018	0	44,961	121,596	0
11-6009	Wildlife Biologist III	FT	P	GP	Fairbanks	99	18S / T	12.0		105,084	1,415	0	55,160	161,659	0
11-6028	Habitat Biologist IV	FT	A	SS	Anchorage	200	20F / J	12.0		86,517	0	0	48,774	135,291	0
11-6045	Habitat Biologist II	FT	A	GP	Anchorage	200	16A	12.0		51,264	690	0	36,533	88,487	0
11-6055	Fish & Game Program Technician	FT	A	GP	Craig	99	12N	4.0	*	18,333	254	0	12,608	31,195	0
11-6096	Fish & Game Program Technician	FT	A	GP	Ketchikan	200	12J	12.0		49,728	669	0	36,001	86,398	0
11-6098	Habitat Biologist III	FT	A	GP	Anchorage	200	18A / B	12.0		60,802	818	0	39,834	101,454	0
11-6118	Fish & Wildlife Technician IV	FT	A	GP	Glennallen	200	13B / C	12.0		43,557	618	2,389	34,692	81,256	0
11-6142	Habitat Biologist III	FT	A	GP	Anchorage	99	18N / O	12.0		85,908	1,156	0	48,523	135,587	0
11-6151	Wildlife Biologist II	PT	A	GP	Fairbanks	203	16G / J	12.0		65,948	888	0	41,615	108,451	0
11-7012	Project Assistant	FT	A	GP	Palmer	200	16C / D	12.0		55,060	741	0	37,847	93,648	0
11-7073	Wildlife Biologist III	FT	A	GP	Juneau	205	18G / J	12.0		77,236	1,040	0	45,522	123,798	43,329
11-7083	Wildlife Biologist II	FT	A	GP	Soldotna	200	16C / D	12.0		55,490	747	0	37,995	94,232	8,952
11-N18034	Habitat Biologist III	NP	N	GP	Fairbanks	203	18A	5.0		25,345	285	0	11,025	36,655	0
11-N20017	Accounting Technician II	NP	A	GP	Juneau	205	14A	12.0		46,860	528	0	24,699	72,087	0

Note: If a position is split, an asterisk (\*) will appear in the Split/Count column. If the split position is also counted in the component, two asterisks (\*\*) will appear in this column. [No valid job title] appearing in the Job Class Title indicates that the PCN has an invalid class code or invalid range for the class code effective date of this scenario.

**Personal Services Expenditure Detail**  
**Department of Fish and Game**

**Scenario:** FY2021 Governor (16414)  
**Component:** Wildlife Conservation (473)  
**RDU:** Wildlife Conservation (147)

PCN	Job Class Title	Time Status	Retire Code	Barg Unit	Location	Salary Sched	Range / Step	Comp Months	Split / Count	Annual Salaries	COLA	Premium Pay	Annual Benefits	Total Costs	UGF Amount
		<b>Total Positions</b>	<b>New</b>	<b>Deleted</b>										<b>Total Salary Costs:</b>	19,780,920
														<b>Total COLA:</b>	173,872
	<b>Full Time Positions:</b>	228	0	0										<b>Total Premium Pay:</b>	112,159
	<b>Part Time Positions:</b>	45	0	0										<b>Total Benefits:</b>	11,828,520
	<b>Non Permanent Positions:</b>	2	0	0											
	<b>Positions in Component:</b>	275	0	0											
	<b>Total Component Months:</b>	3,186.4													
														<b>Total Pre-Vacancy:</b>	31,895,471
														<b>Minus Vacancy Adjustment of 6.62%:</b>	(2,110,471)
														<b>Total Post-Vacancy:</b>	29,785,000
														<b>Plus Lump Sum Premium Pay:</b>	160,000
														<b>Personal Services Line 100:</b>	29,945,000

<b>PCN Funding Sources:</b>	<b>Pre-Vacancy</b>	<b>Post-Vacancy</b>	<b>Percent</b>
1002 Federal Receipts	20,059,413	18,732,115	62.89%
1004 General Fund Receipts	1,098,244	1,025,575	3.44%
1007 Interagency Receipts	490,535	458,077	1.54%
1024 Fish and Game Fund	9,053,816	8,454,739	28.39%
1061 Capital Improvement Project Receipts	1,005,084	938,580	3.15%
1108 Statutory Designated Program Receipts	188,376	175,912	0.59%
<b>Total PCN Funding:</b>	<b>31,895,468</b>	<b>29,784,997</b>	<b>100.00%</b>

<b>Lump Sum Funding Sources:</b>	<b>Amount</b>	<b>Percent</b>
1108 Federal Receipts	120,000	75.00%
1108 Fish and Game Fund	40,000	25.00%
<b>Total Lump Sum Funding:</b>	<b>160,000</b>	<b>100.00%</b>

Note: If a position is split, an asterisk (\*) will appear in the Split/Count column. If the split position is also counted in the component, two asterisks (\*\*) will appear in this column. [No valid job title] appearing in the Job Class Title indicates that the PCN has an invalid class code or invalid range for the class code effective date of this scenario.

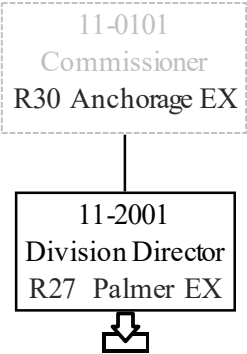

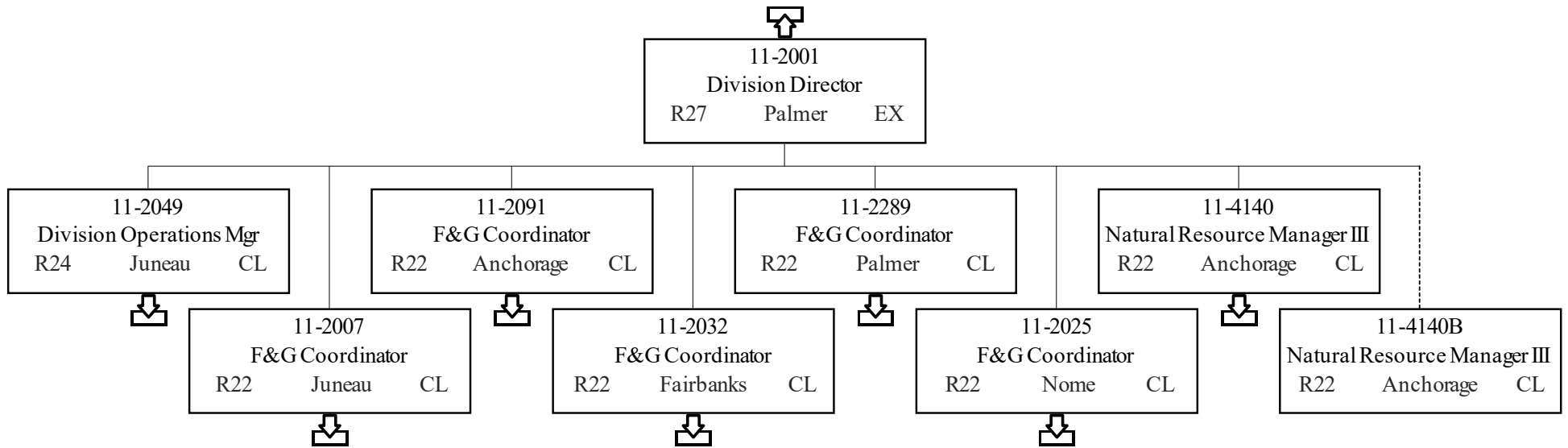



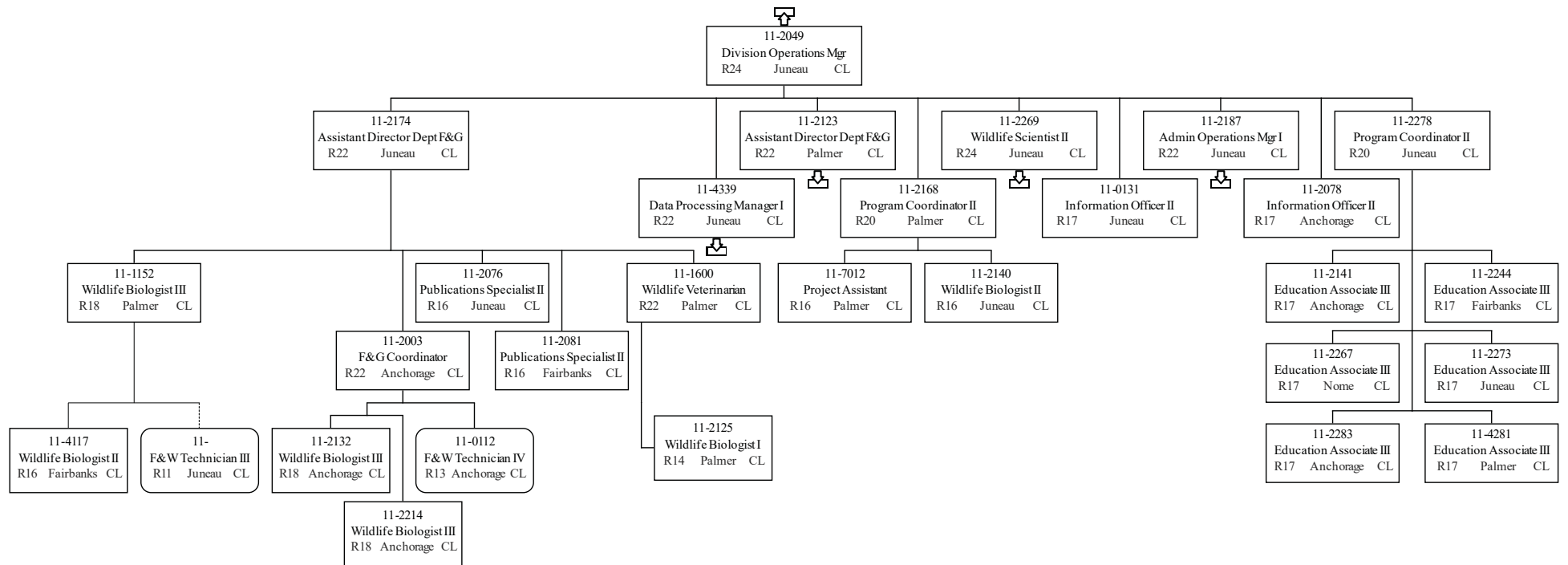

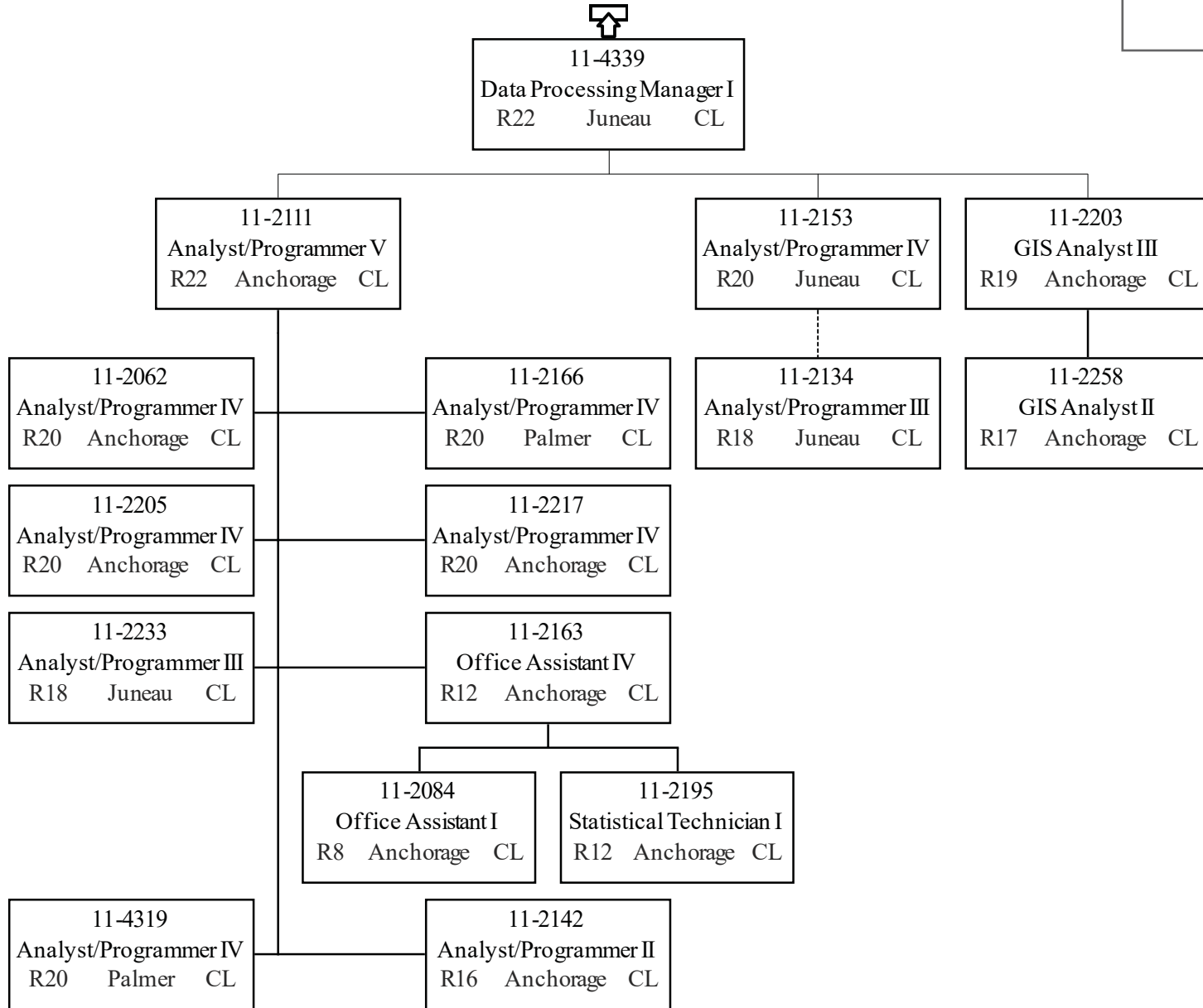

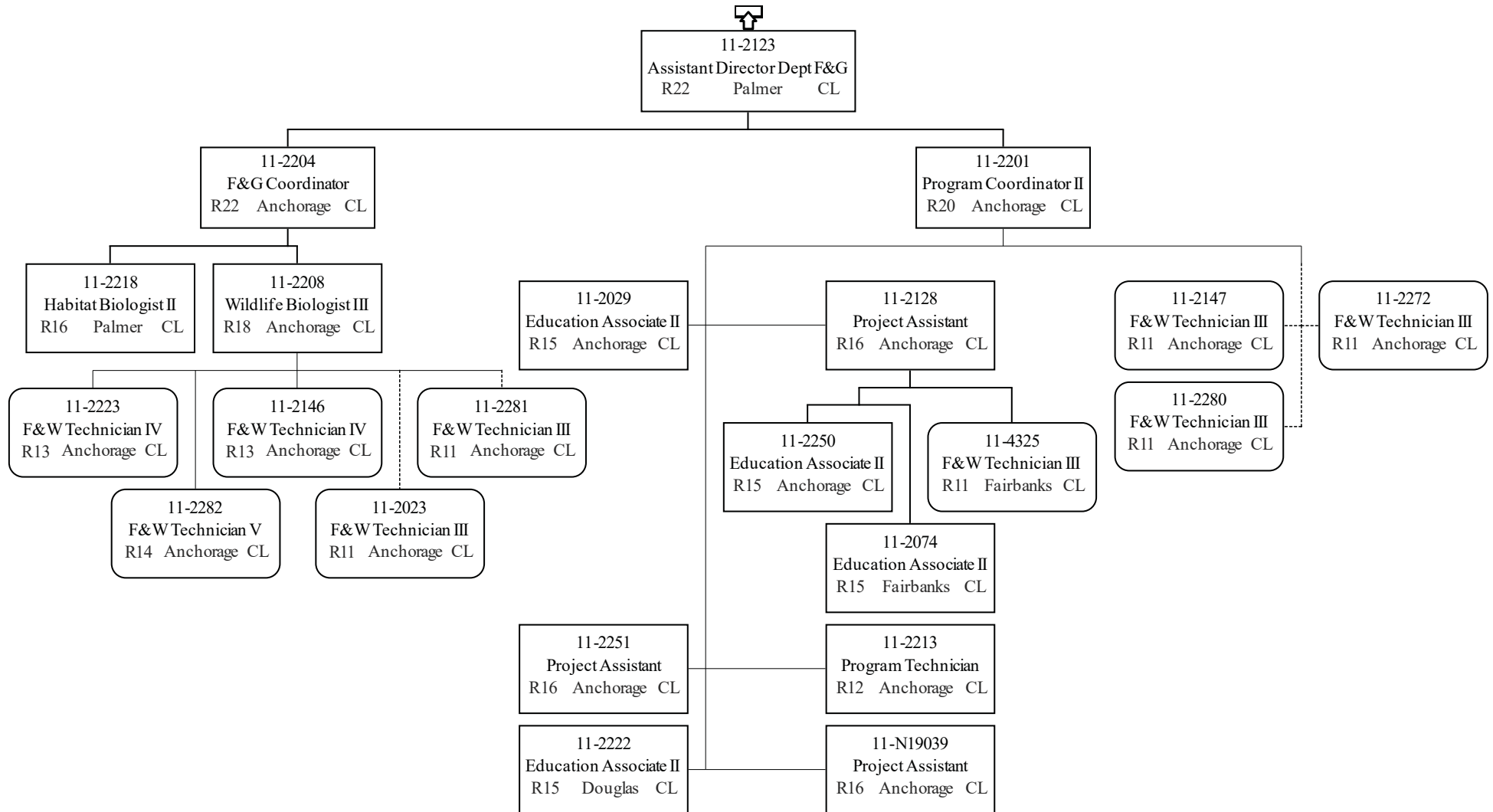

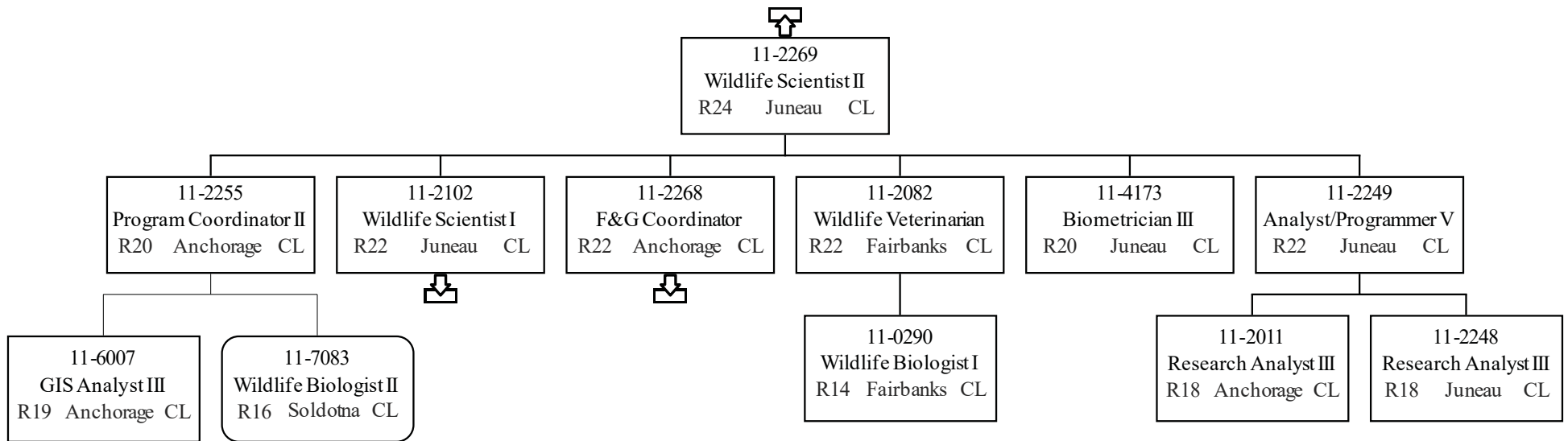

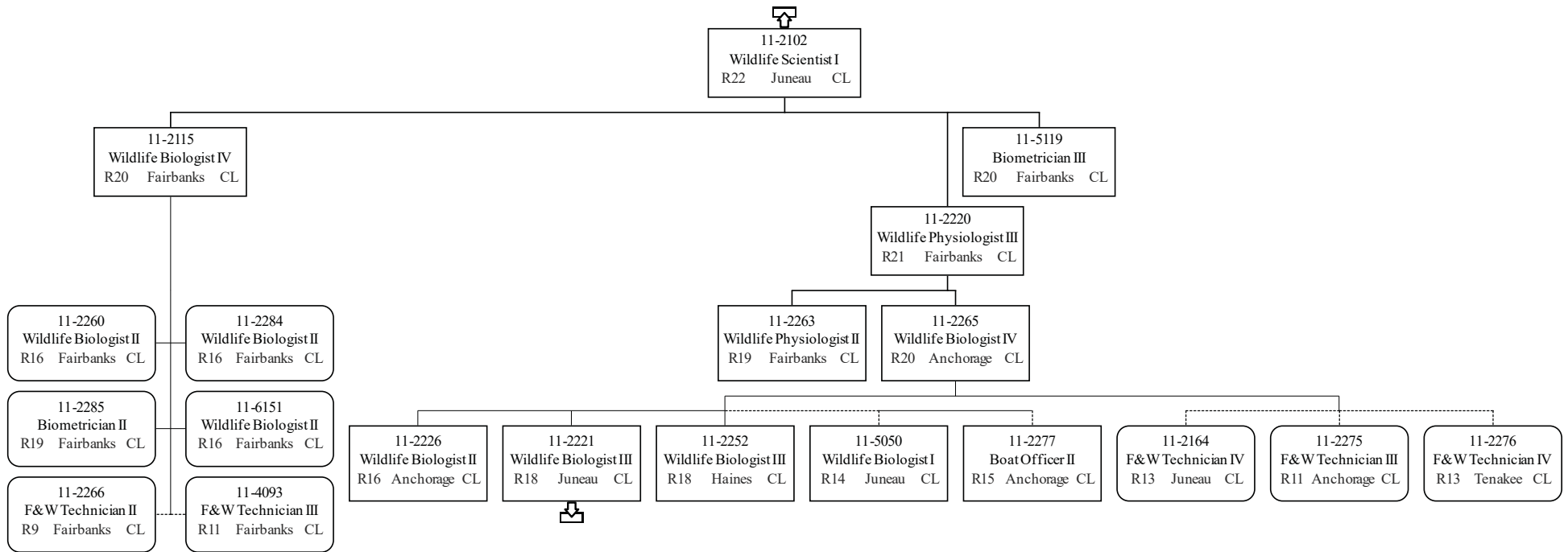

 Permanent Full-time  
 Permanent Part-Time & Seasonal



11-2221  
Wildlife Biologist III  
R18 Juneau CL

