

<span style="border: 1px solid black; display: inline-block; width: 20px; height: 10px;"></span>	Permanent Full-time
<span style="border: 1px solid black; border-radius: 50%; display: inline-block; width: 20px; height: 10px;"></span>	Permanent Part-Time & Seasonal

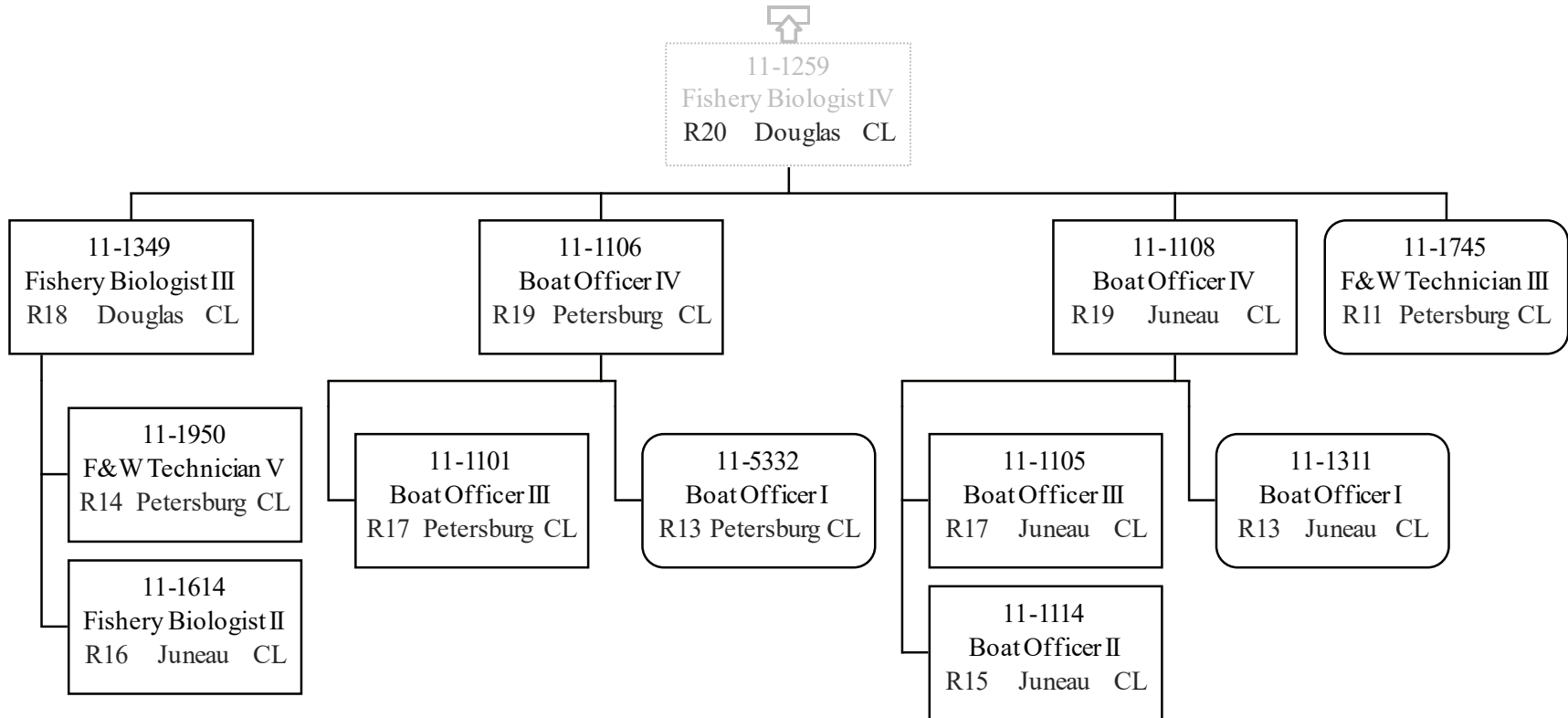

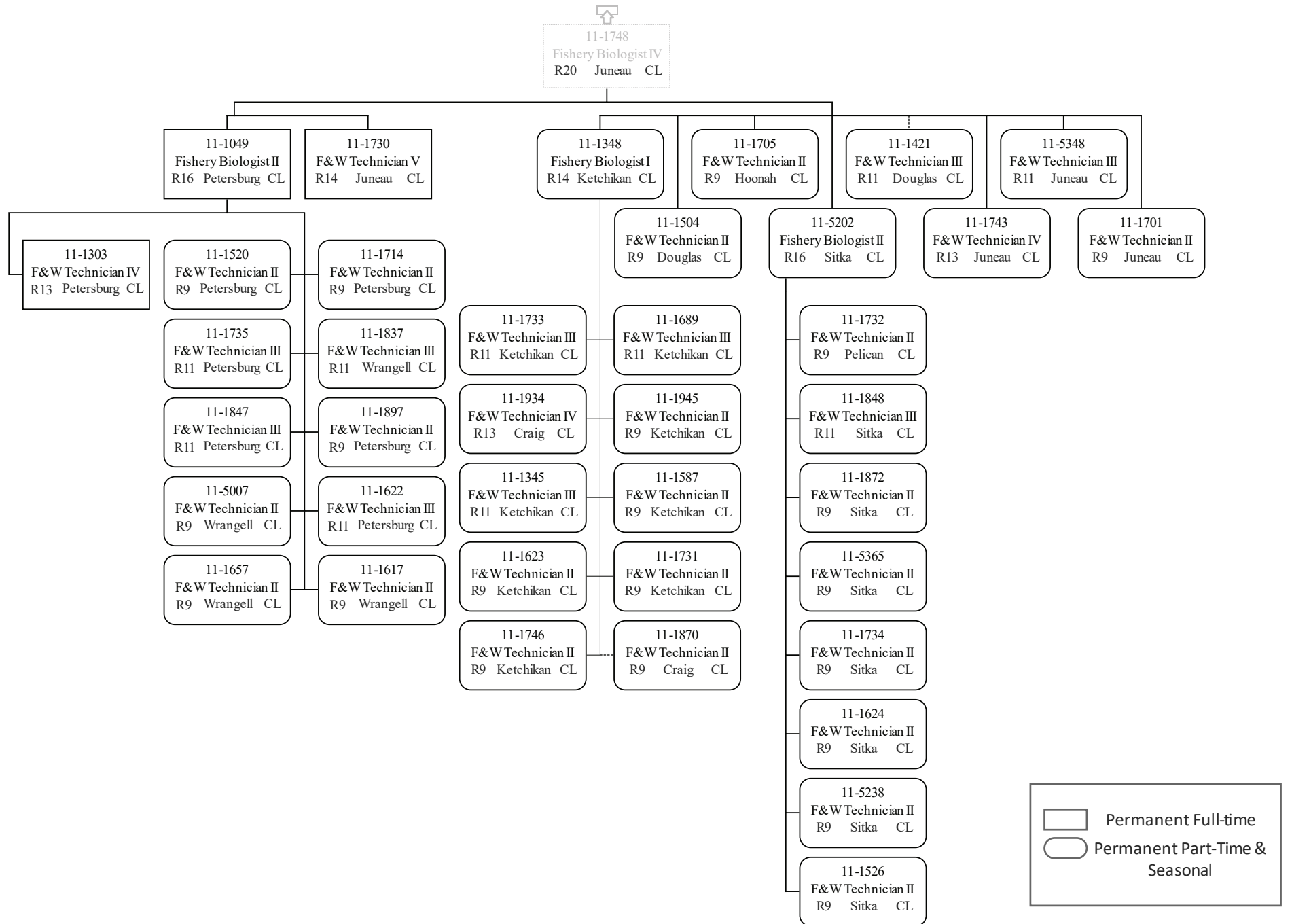

Permanent Full-time  
 Permanent Part-Time & Seasonal

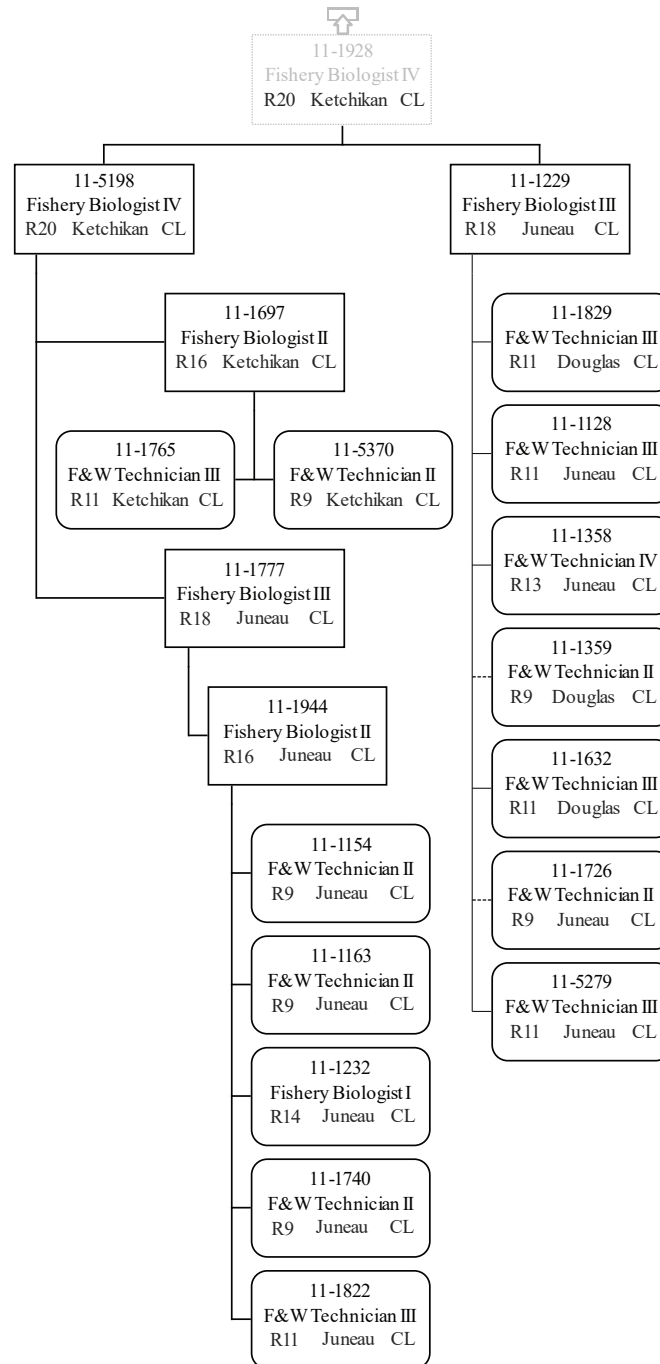

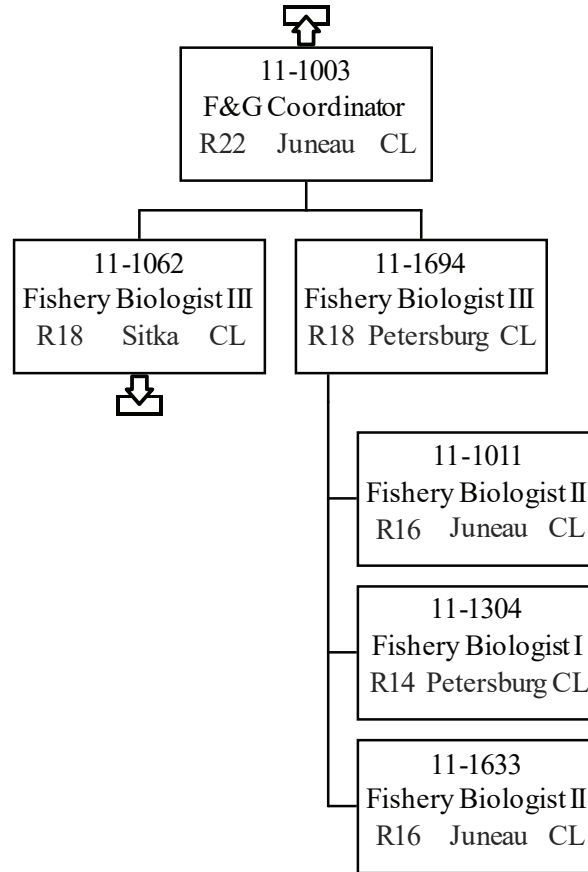



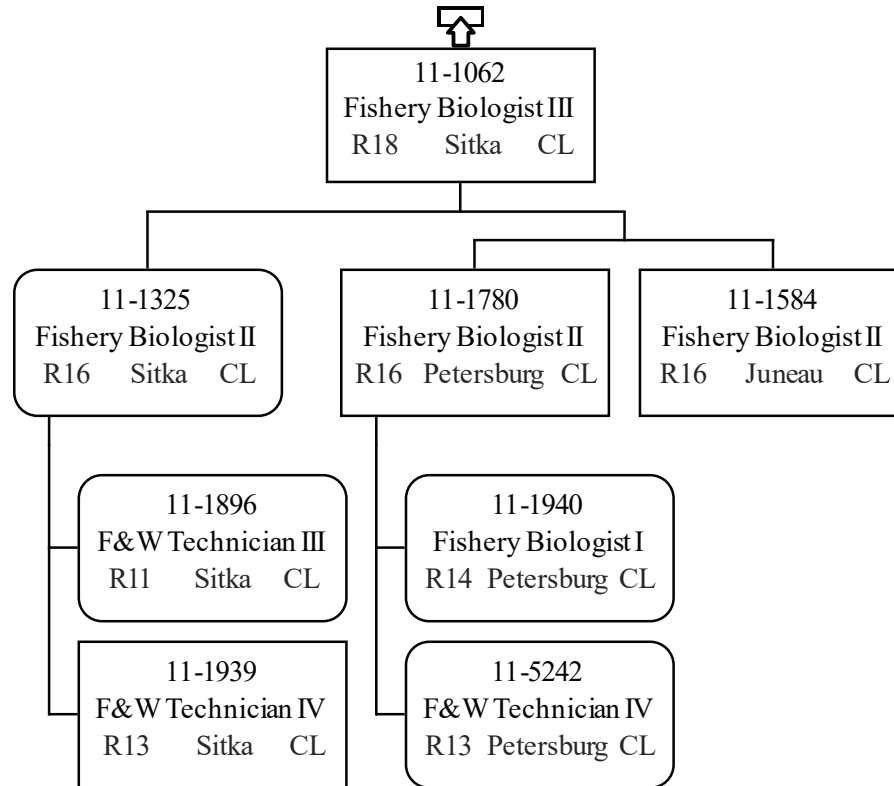

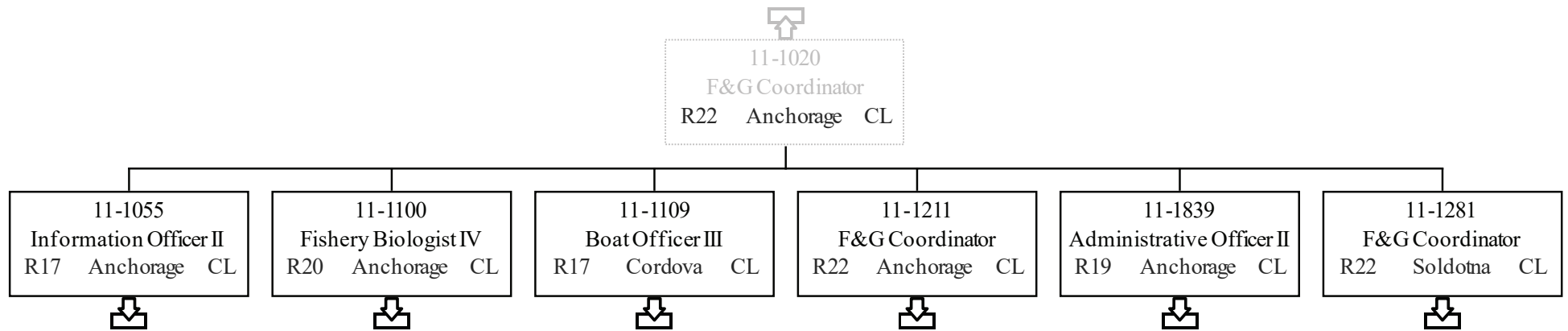

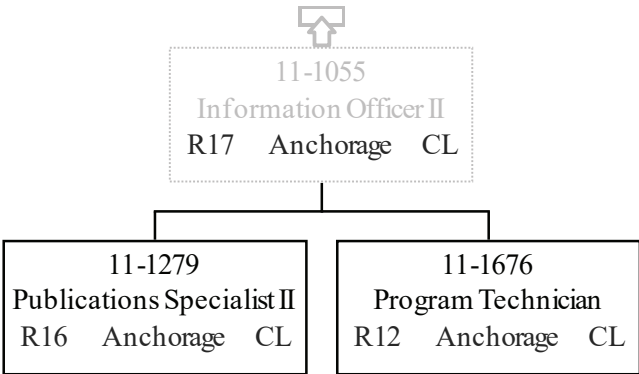

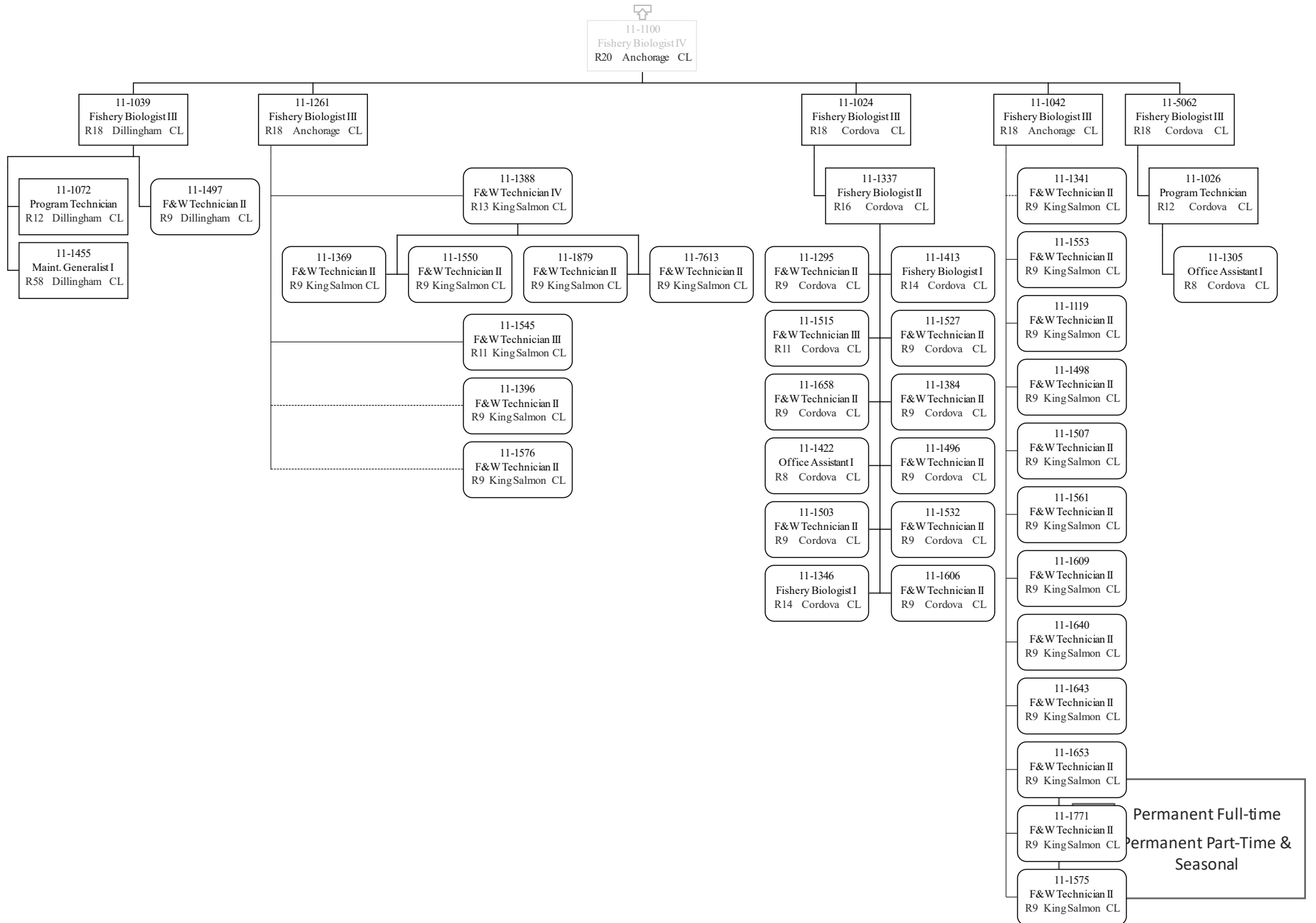

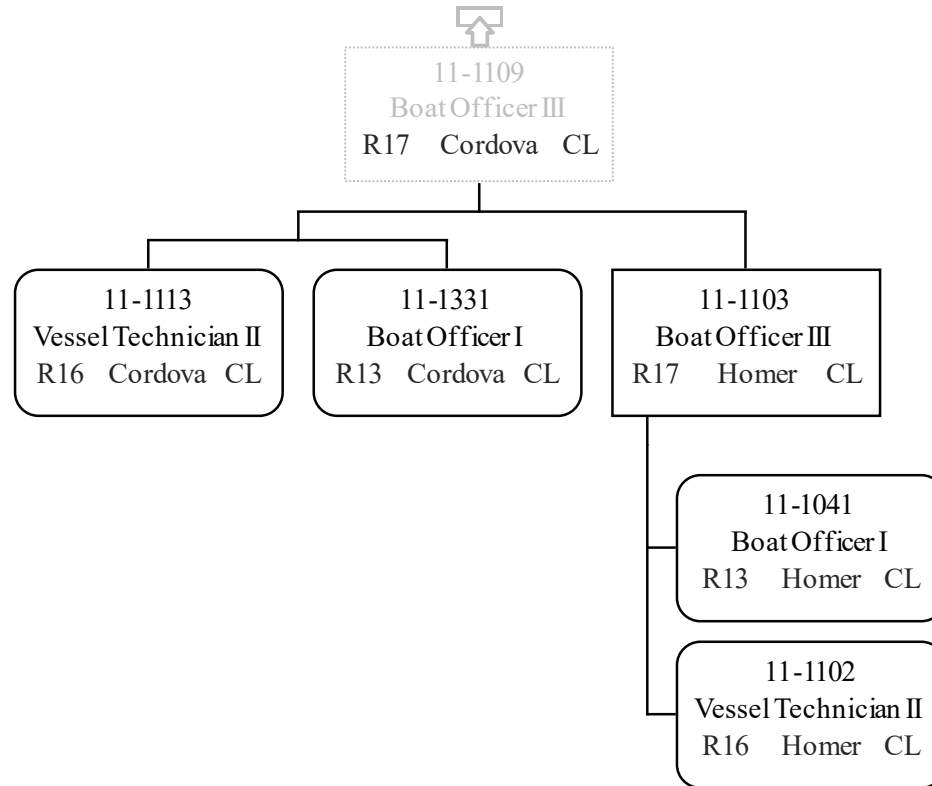

Department of Fish & Game  
 2171 - Headquarters Fish Management  
 FY2021 Governor Budget

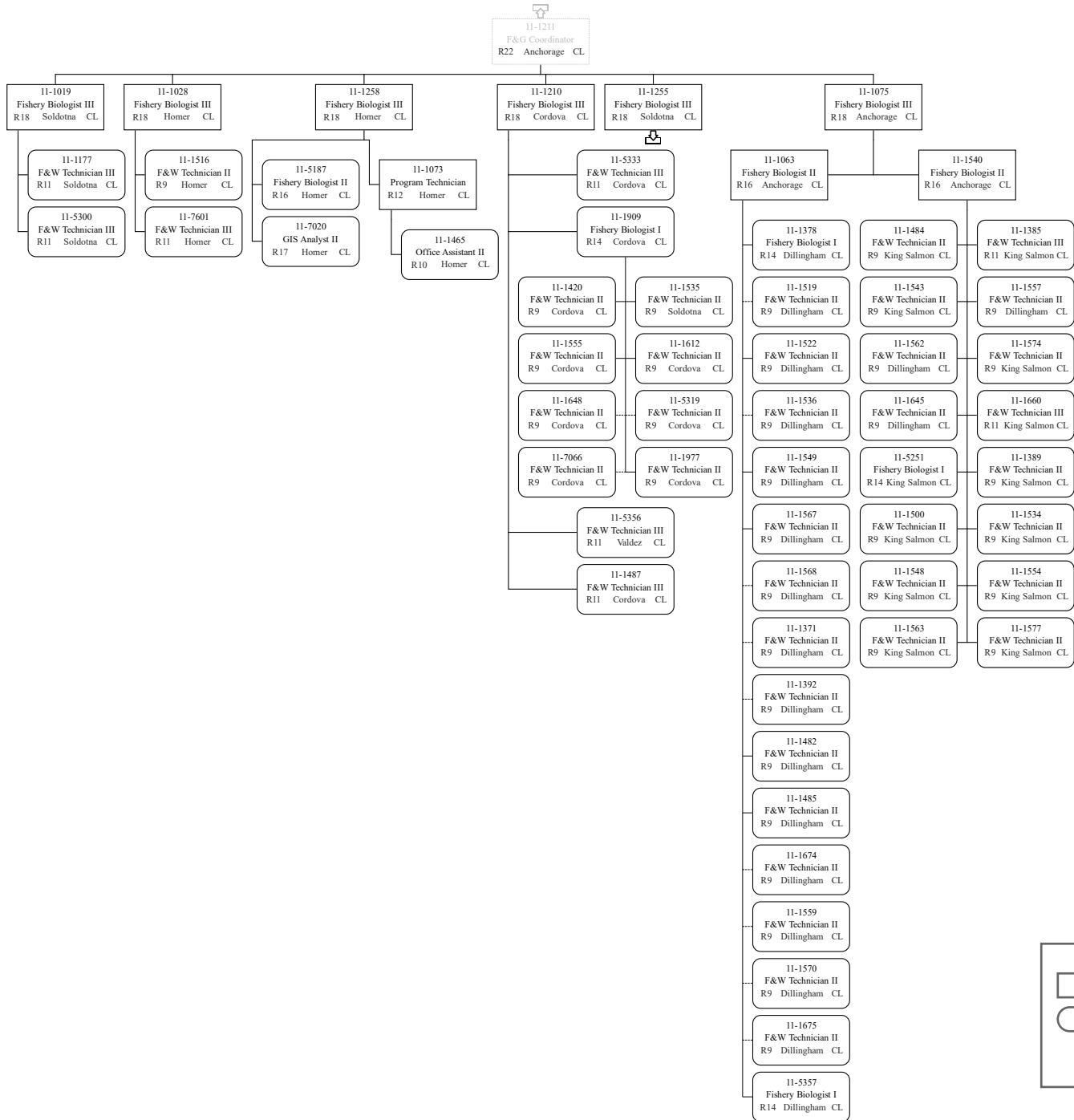

	Permanent Full-time
	Permanent Part-Time & Seasonal

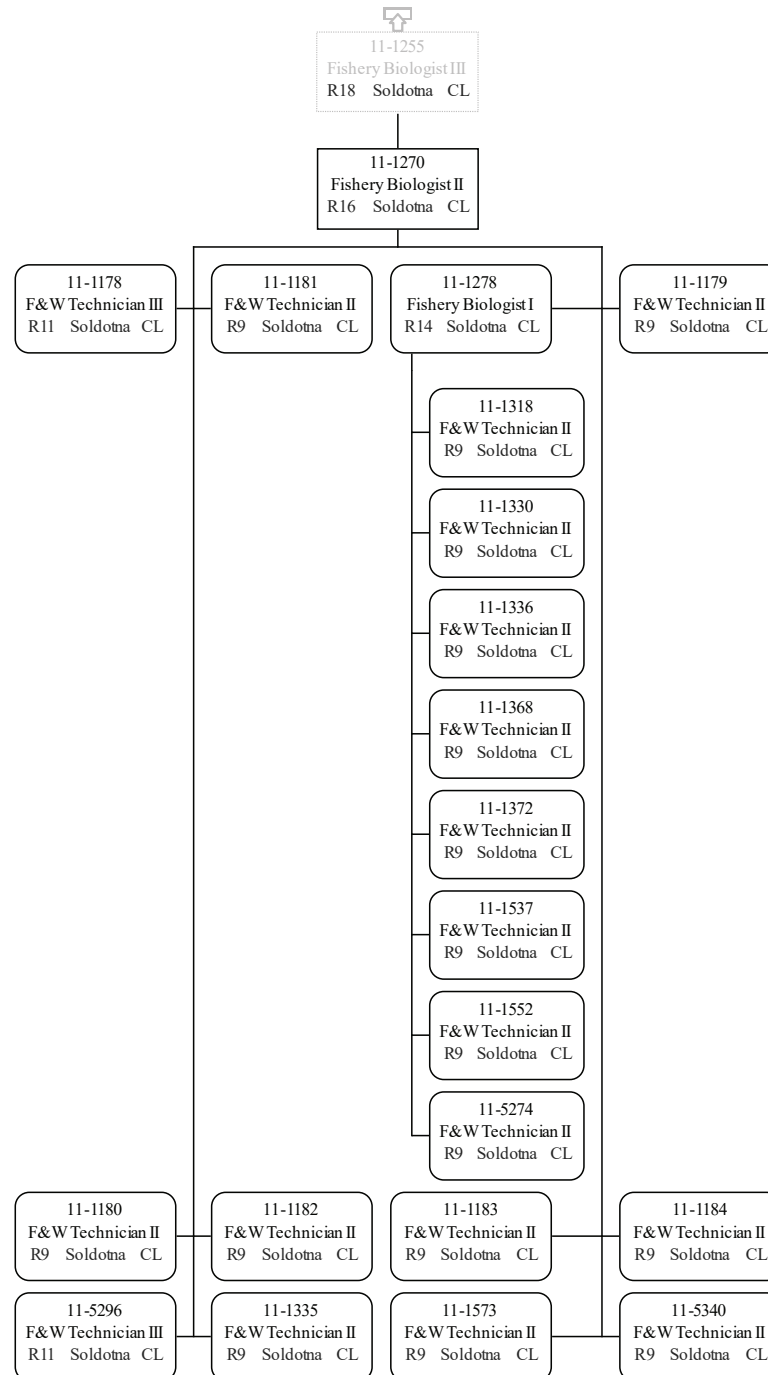

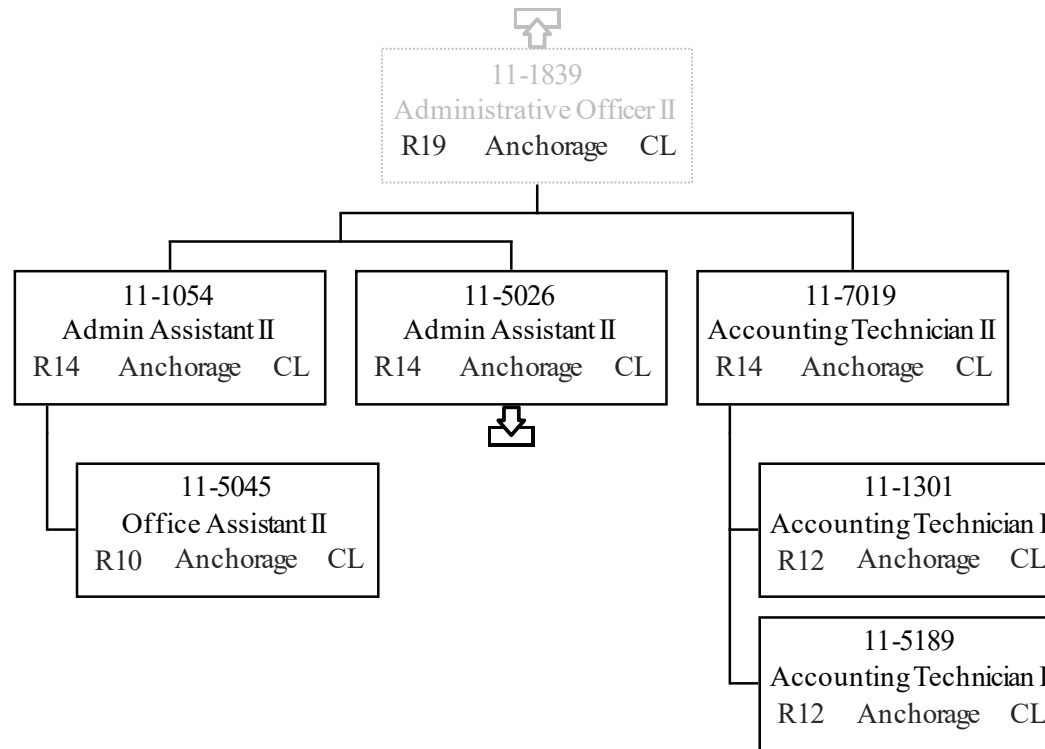



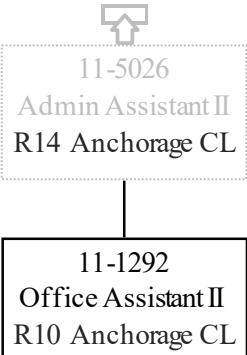

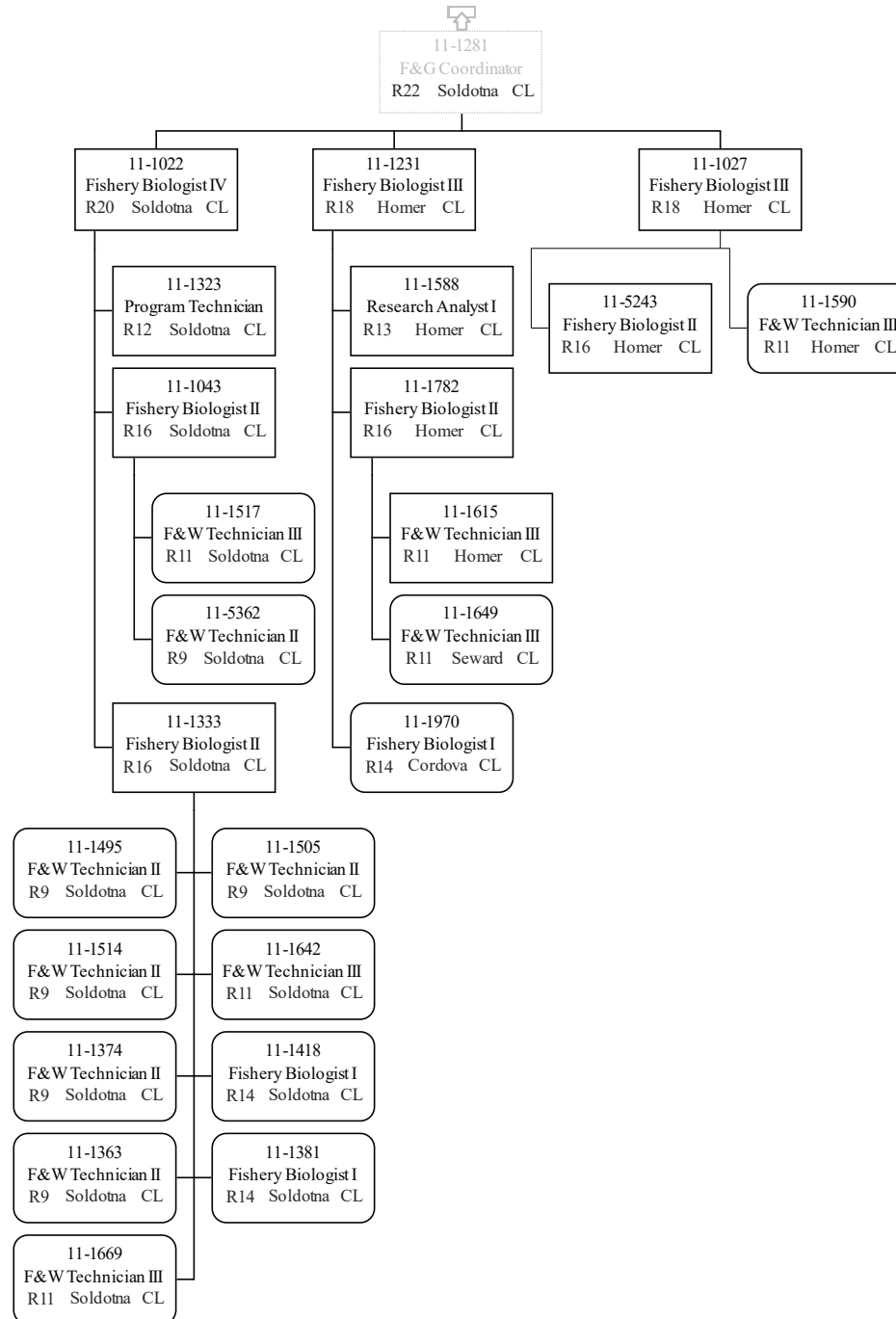

Department of Fish & Game  
 2171 - Headquarters Fish Management  
 FY2021 Governor Budget

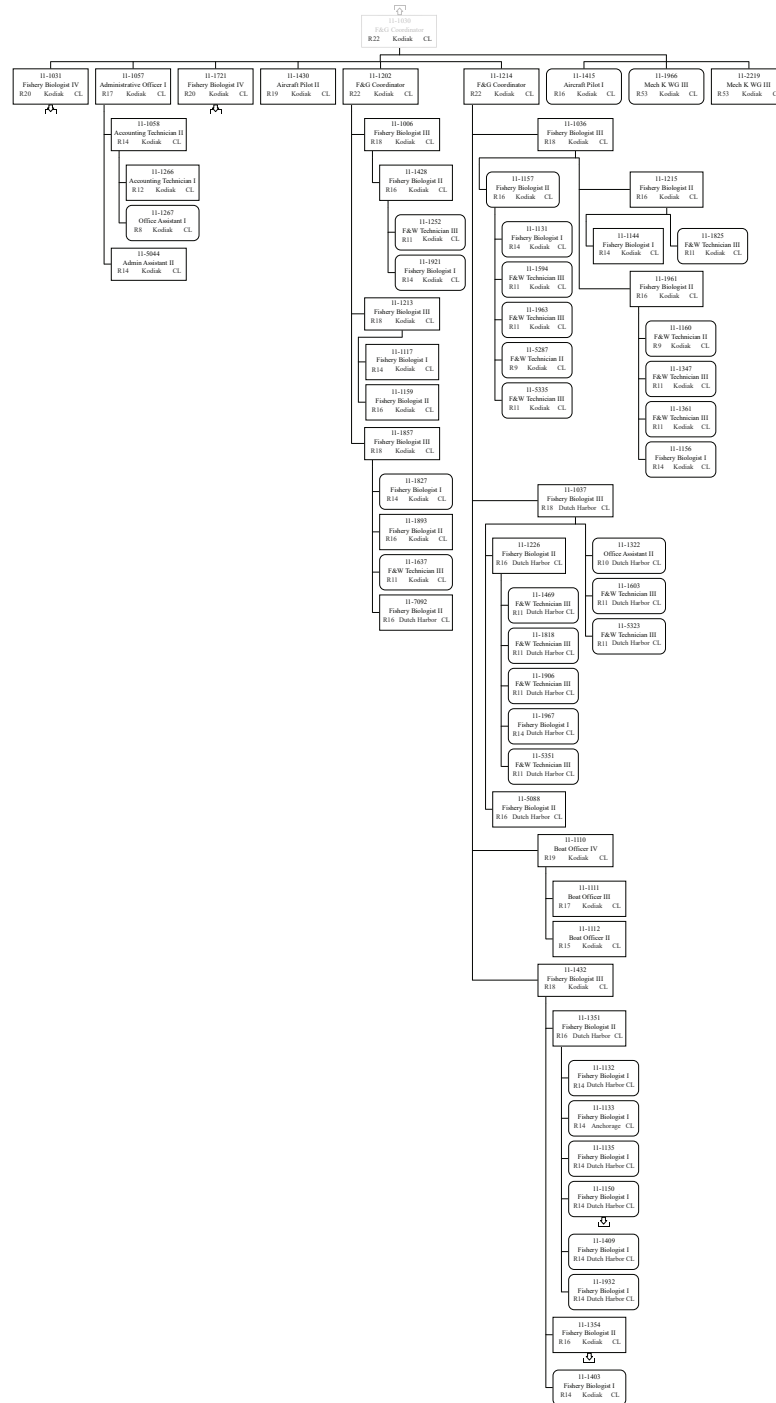

Permanent Full-time  
 Permanent Part-Time & Seasonal

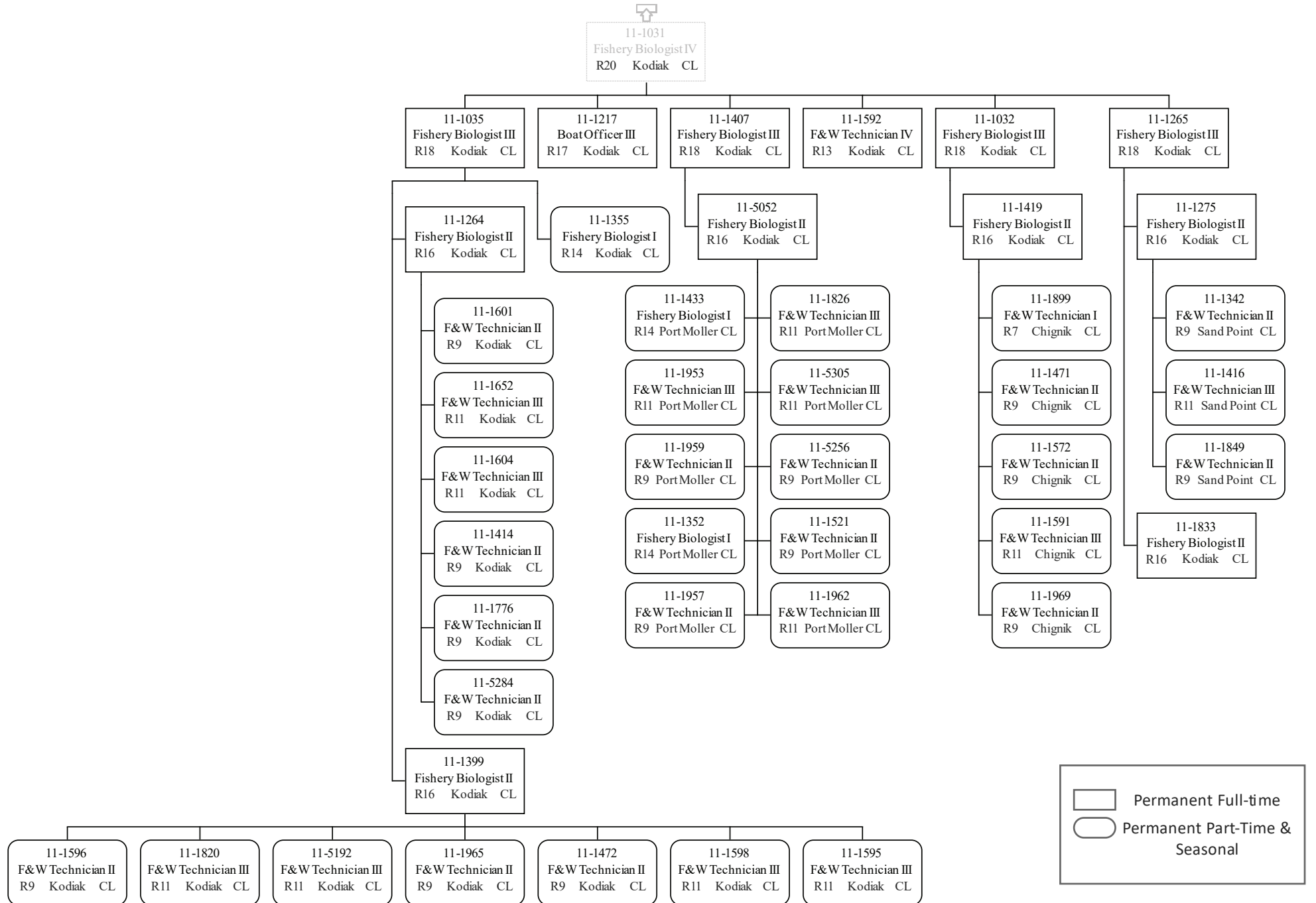

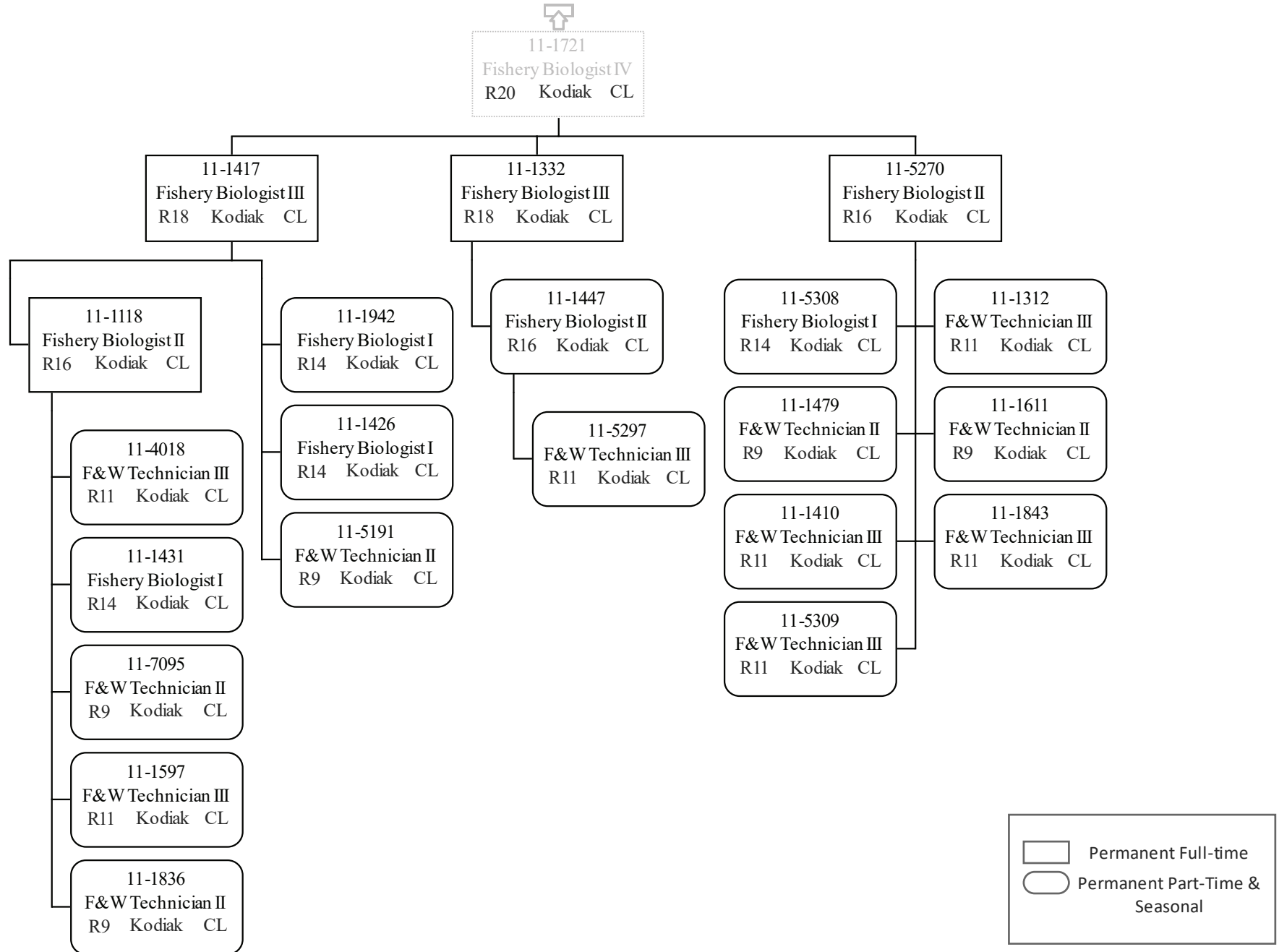



11-1150  
Fishery Biologist I  
R14 Dutch Harbor CL

	Permanent Full-time
	Permanent Part-Time & Seasonal



11-1354  
Fishery Biologist II  
R16 Kodiak CL

	Permanent Full-time
	Permanent Part-Time & Seasonal

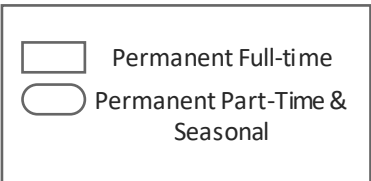
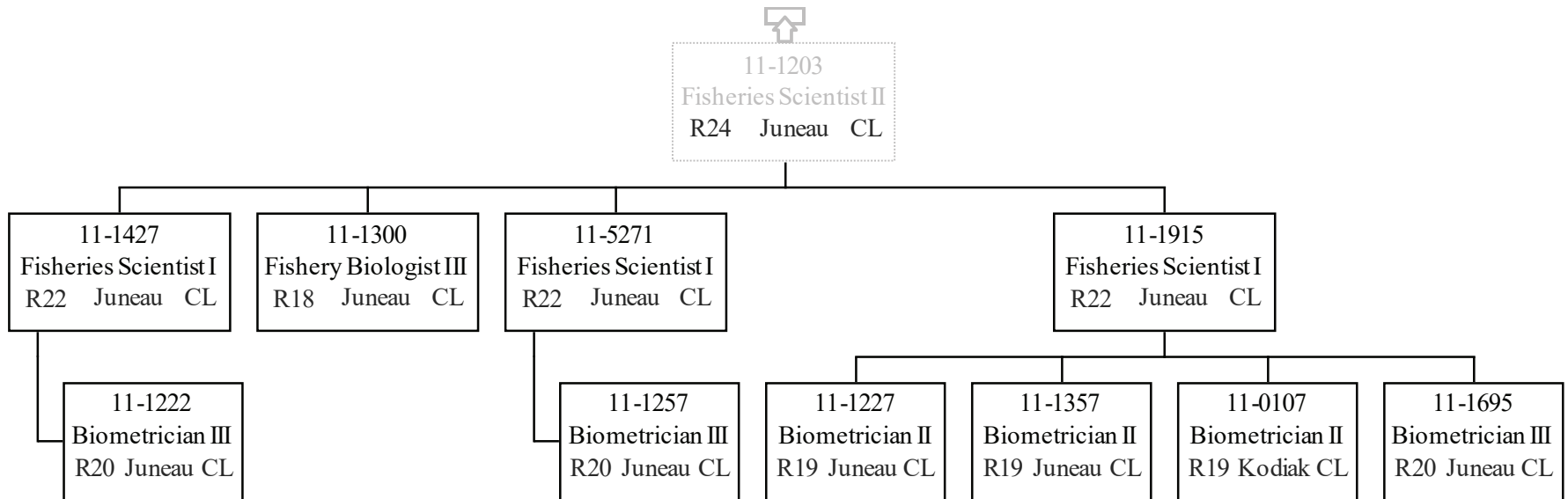



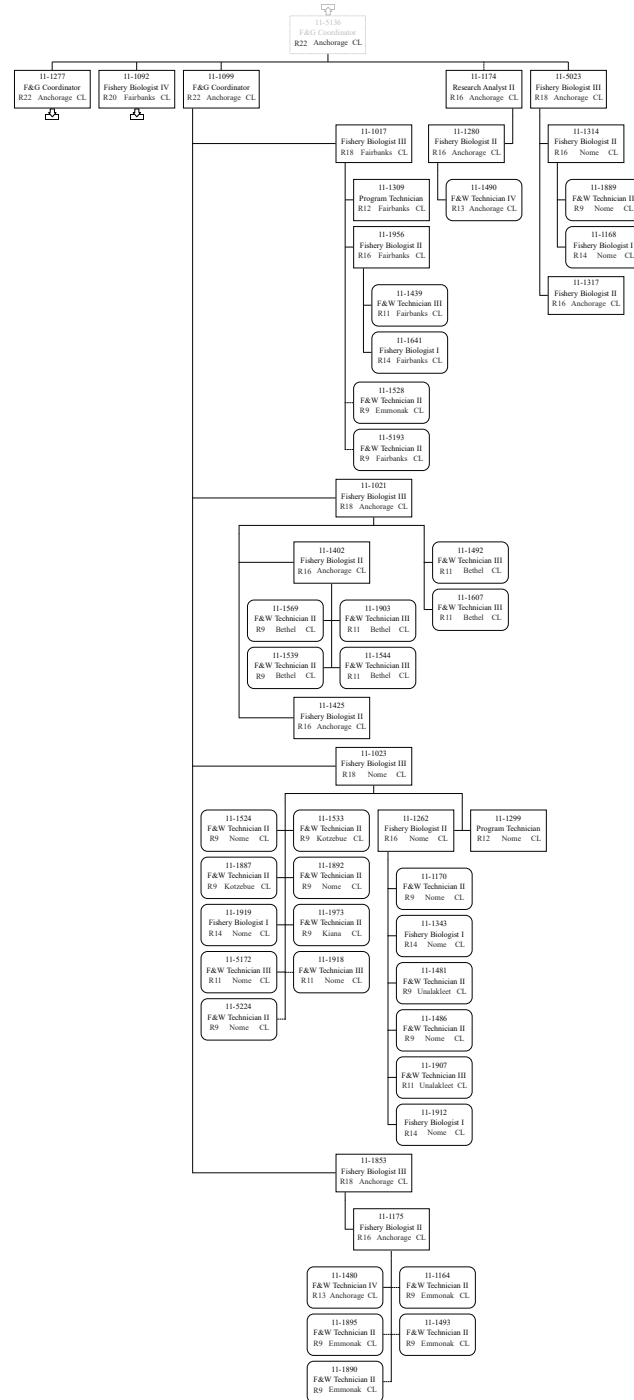

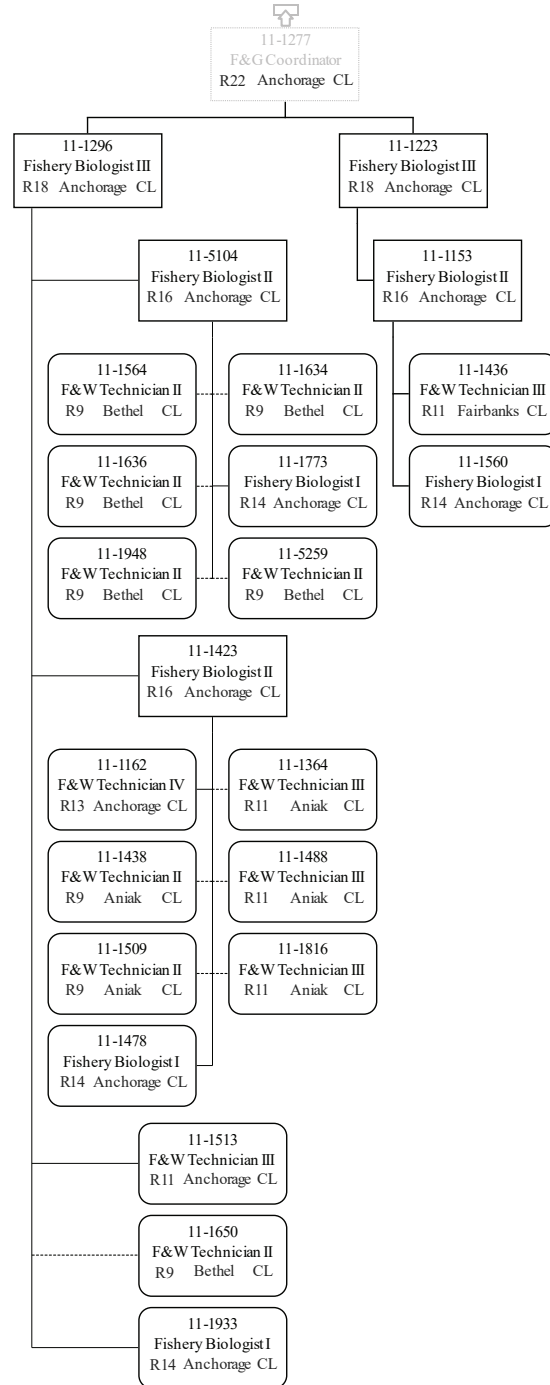

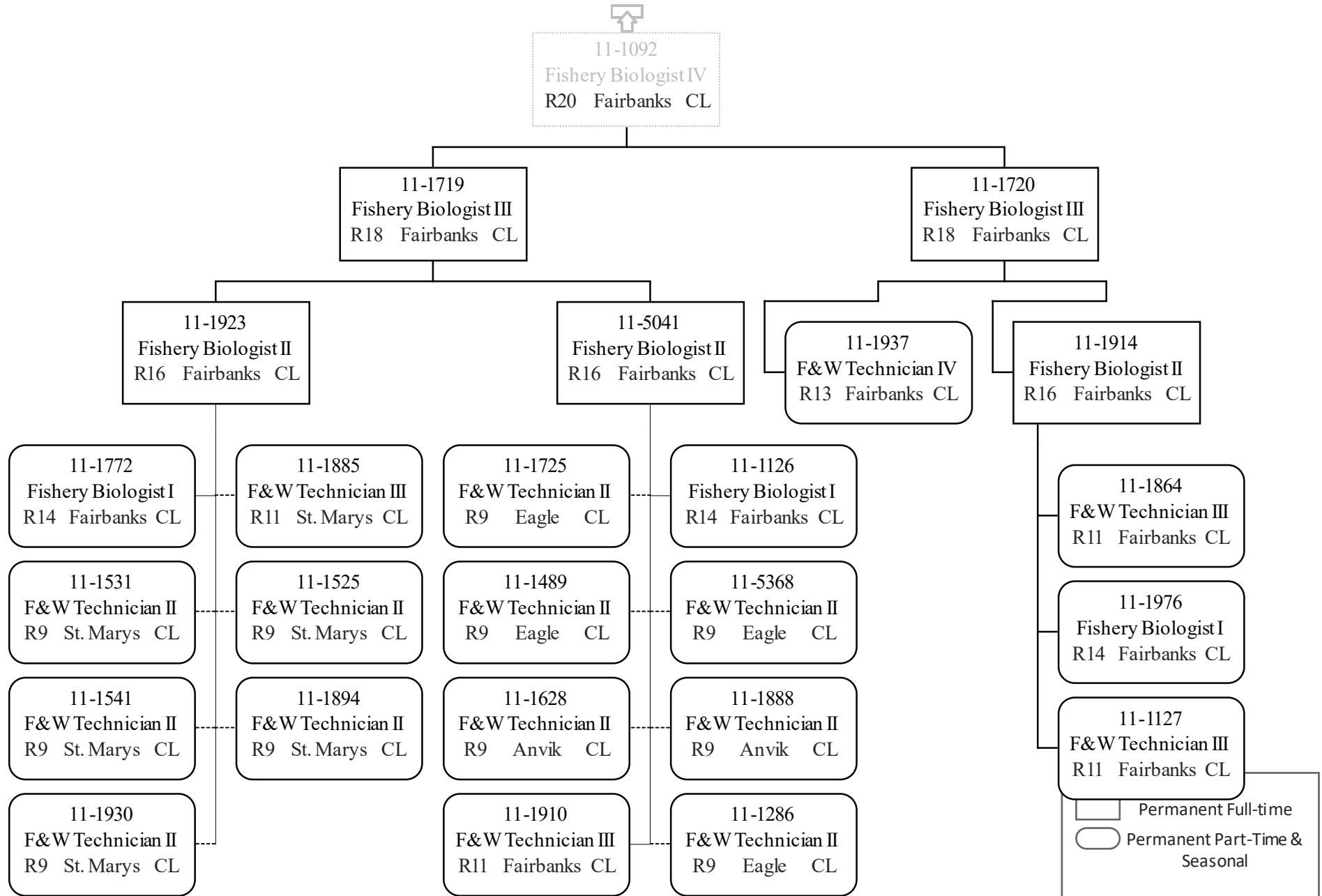

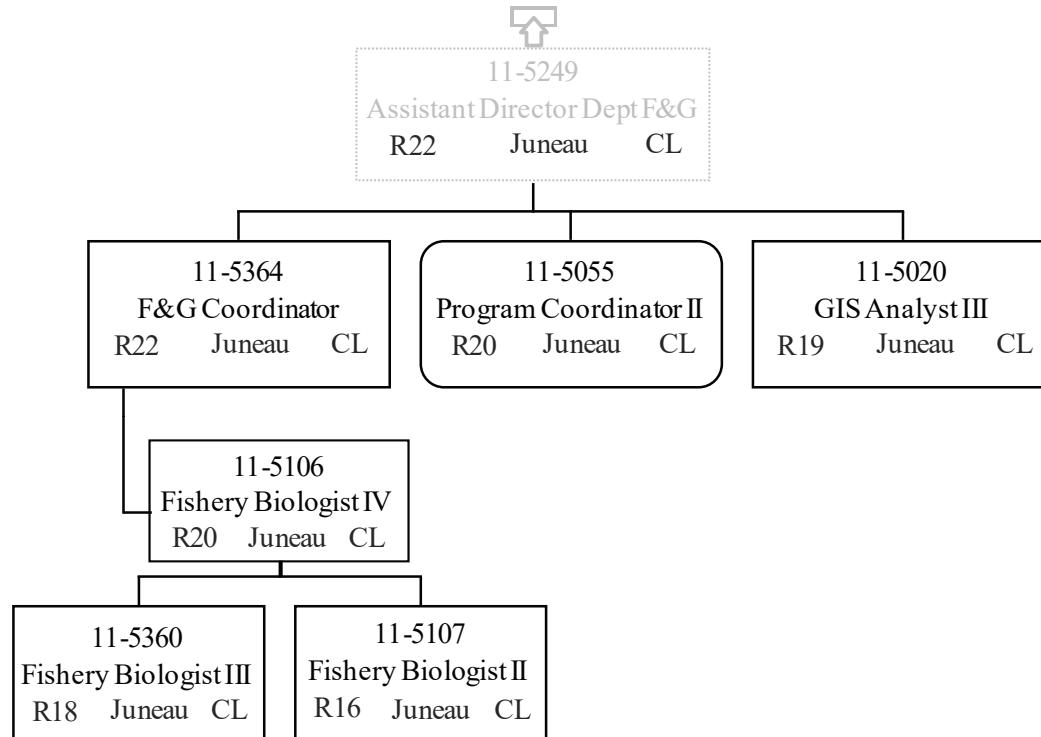

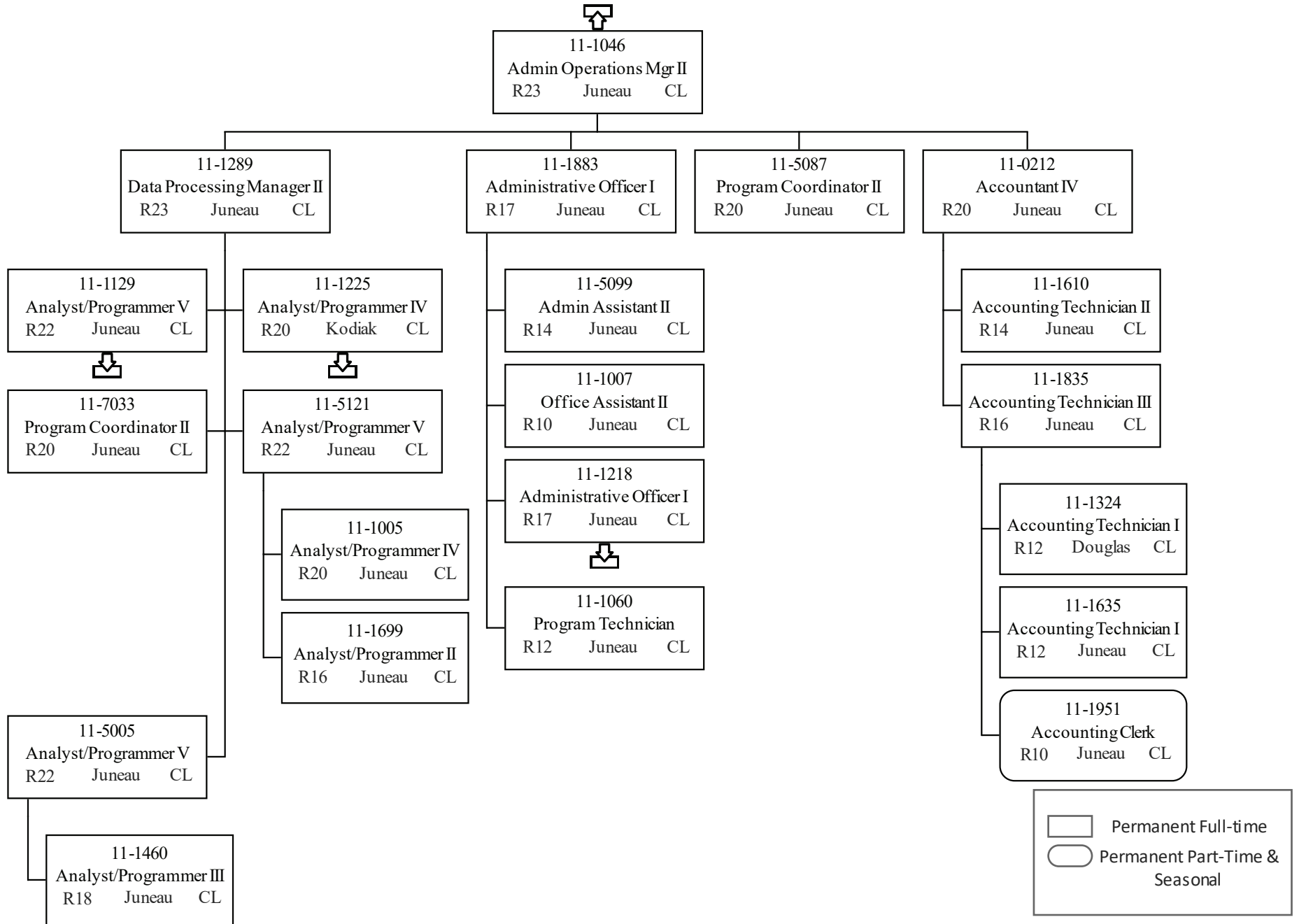

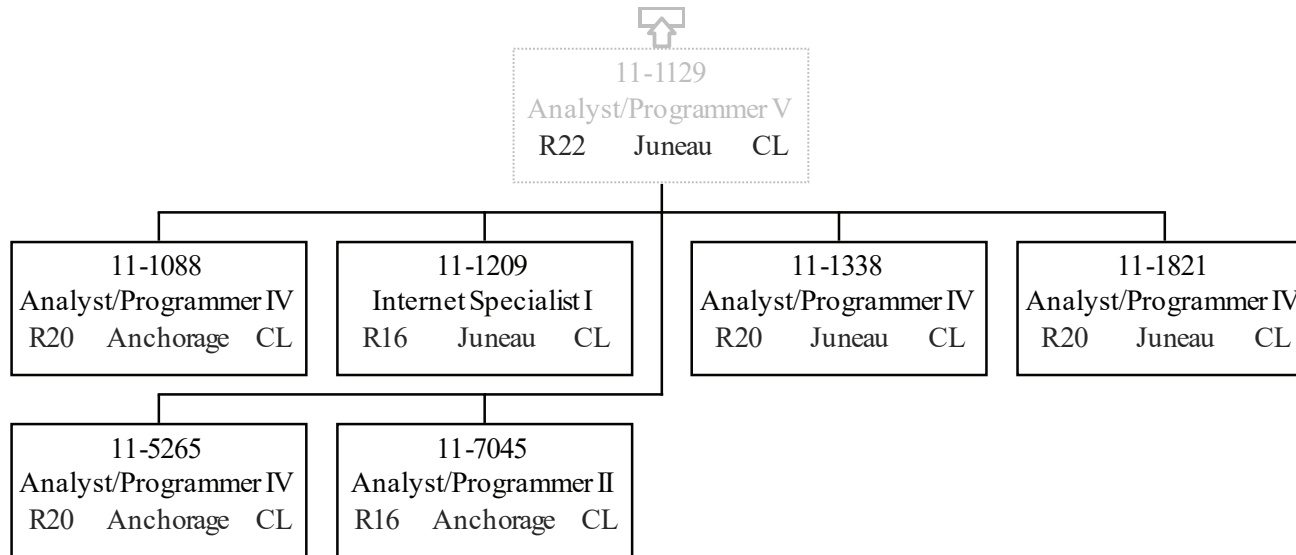

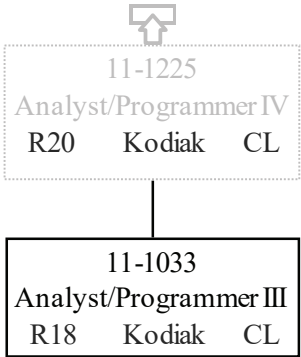

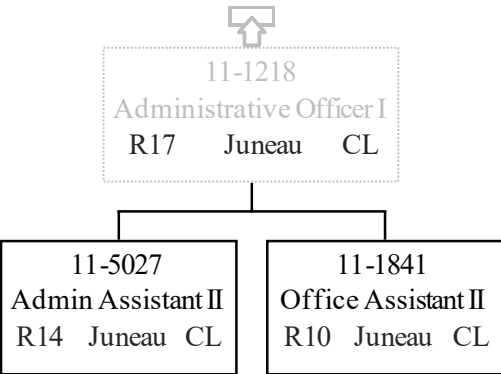



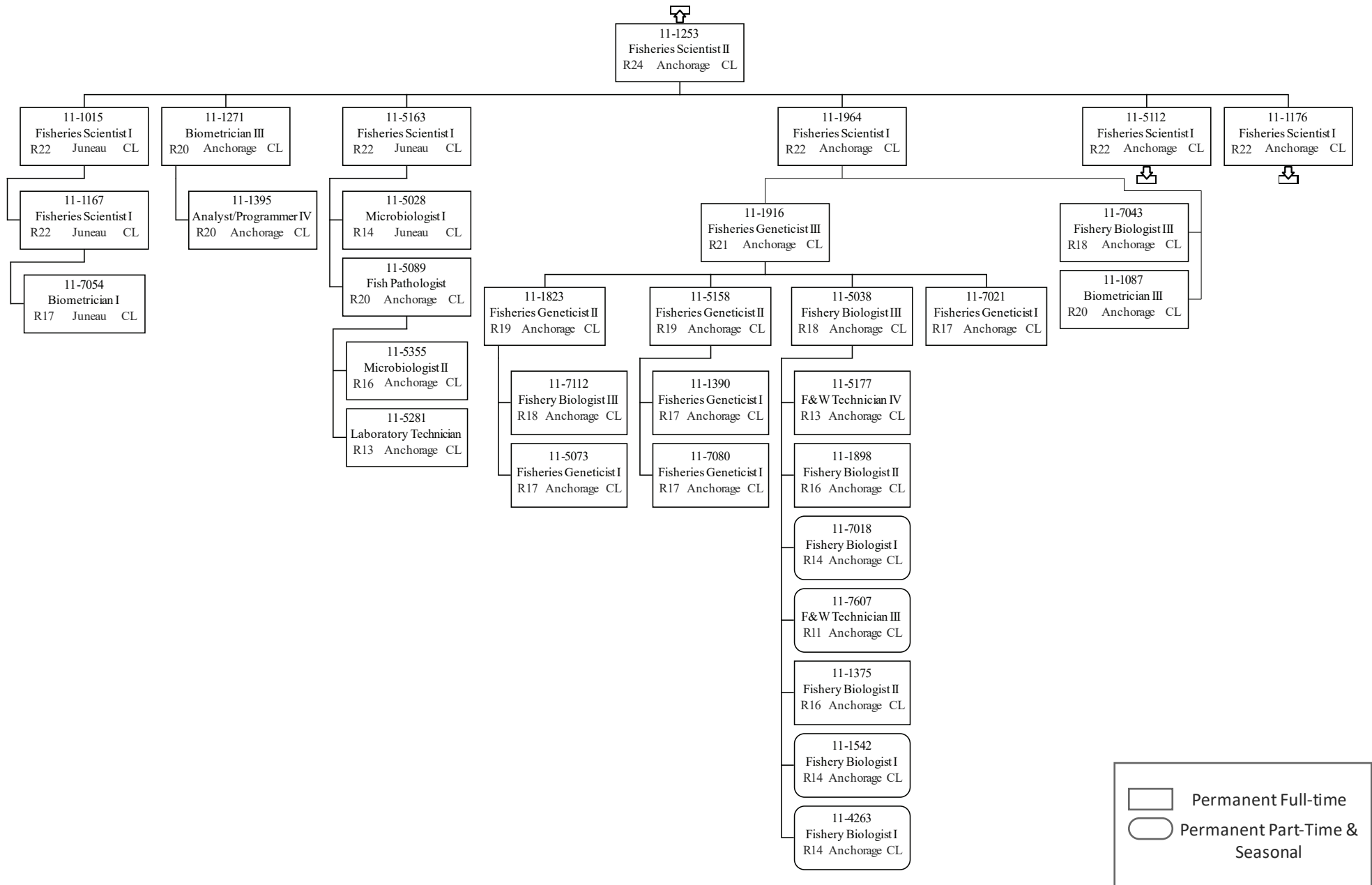

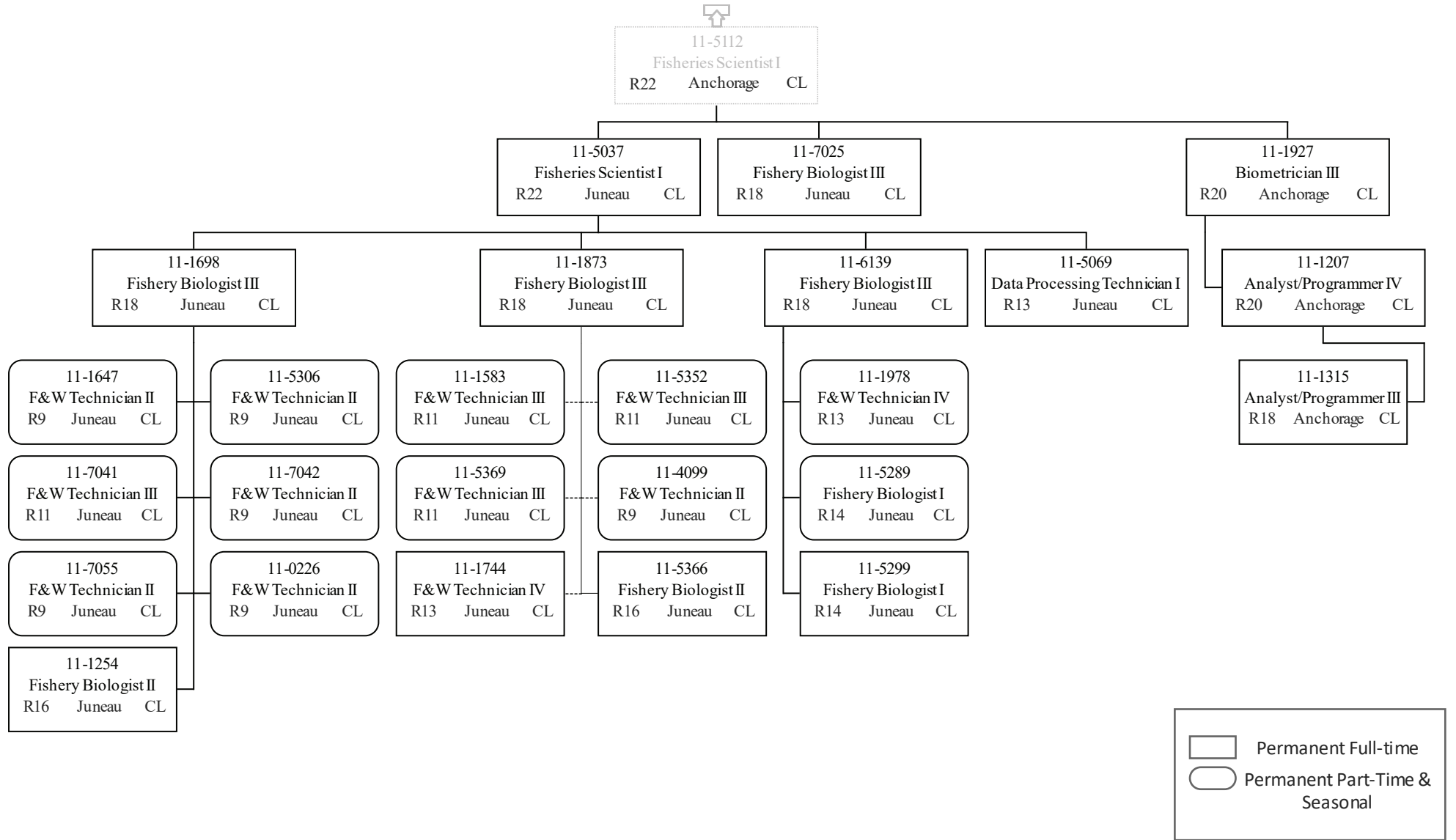



11-1176  
Fisheries Scientist I  
R22 Anchorage CL

	Permanent Full-time
	Permanent Part-Time & Seasonal