

# Senior and Disabilities Services Organizational Management

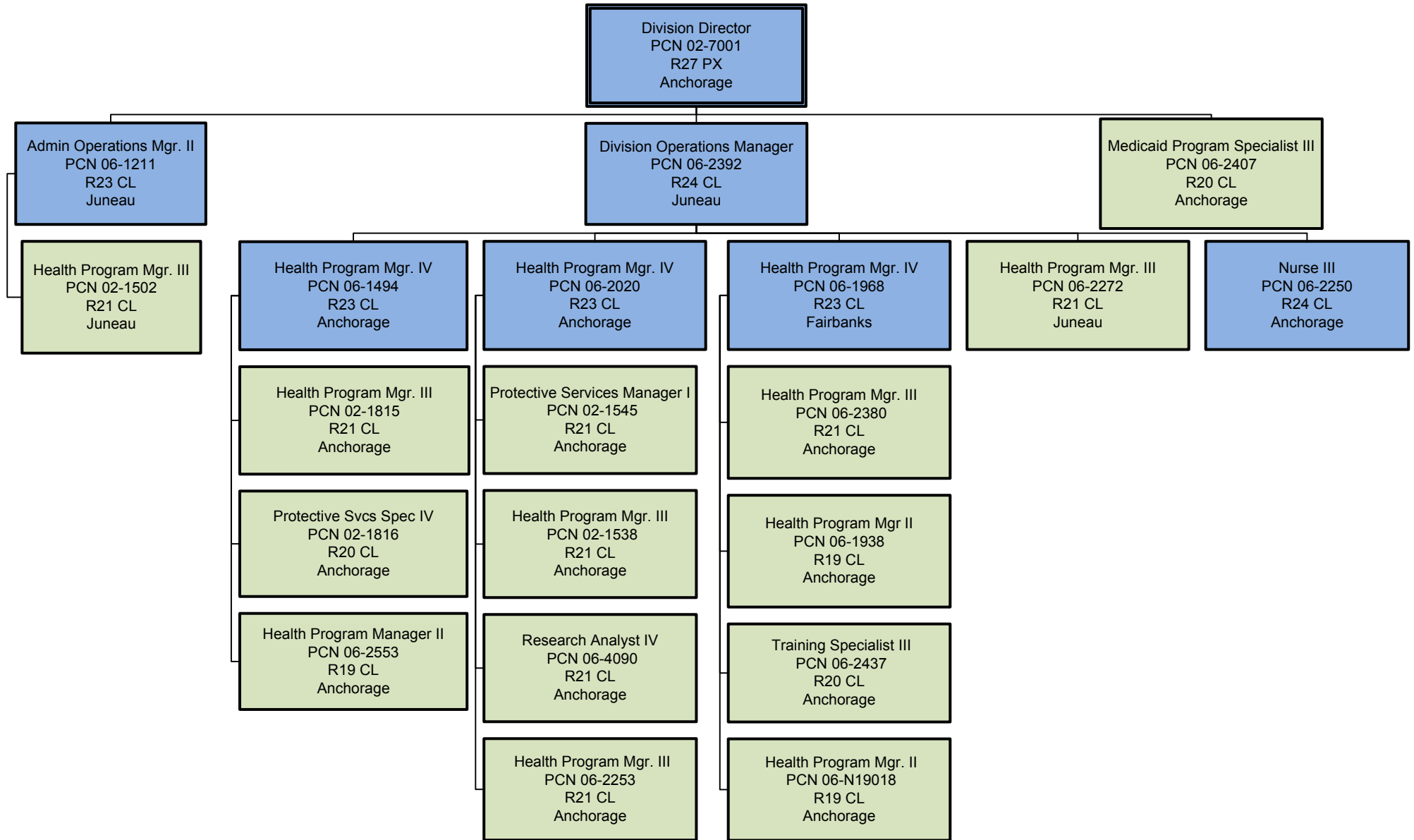

# Senior and Disabilities Services Admin and Grant Support

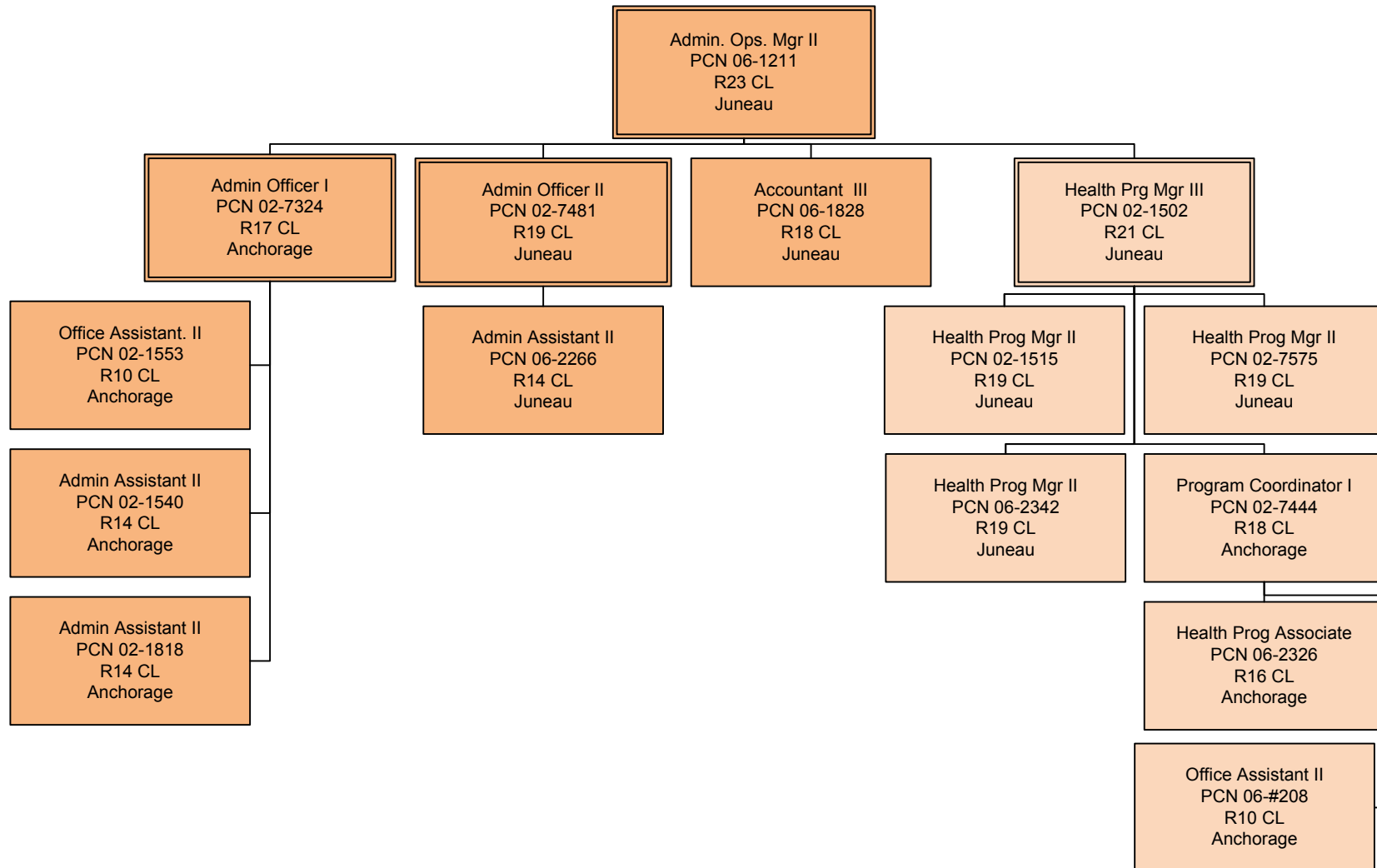

# Senior and Disabilities Services Adult Protective Services

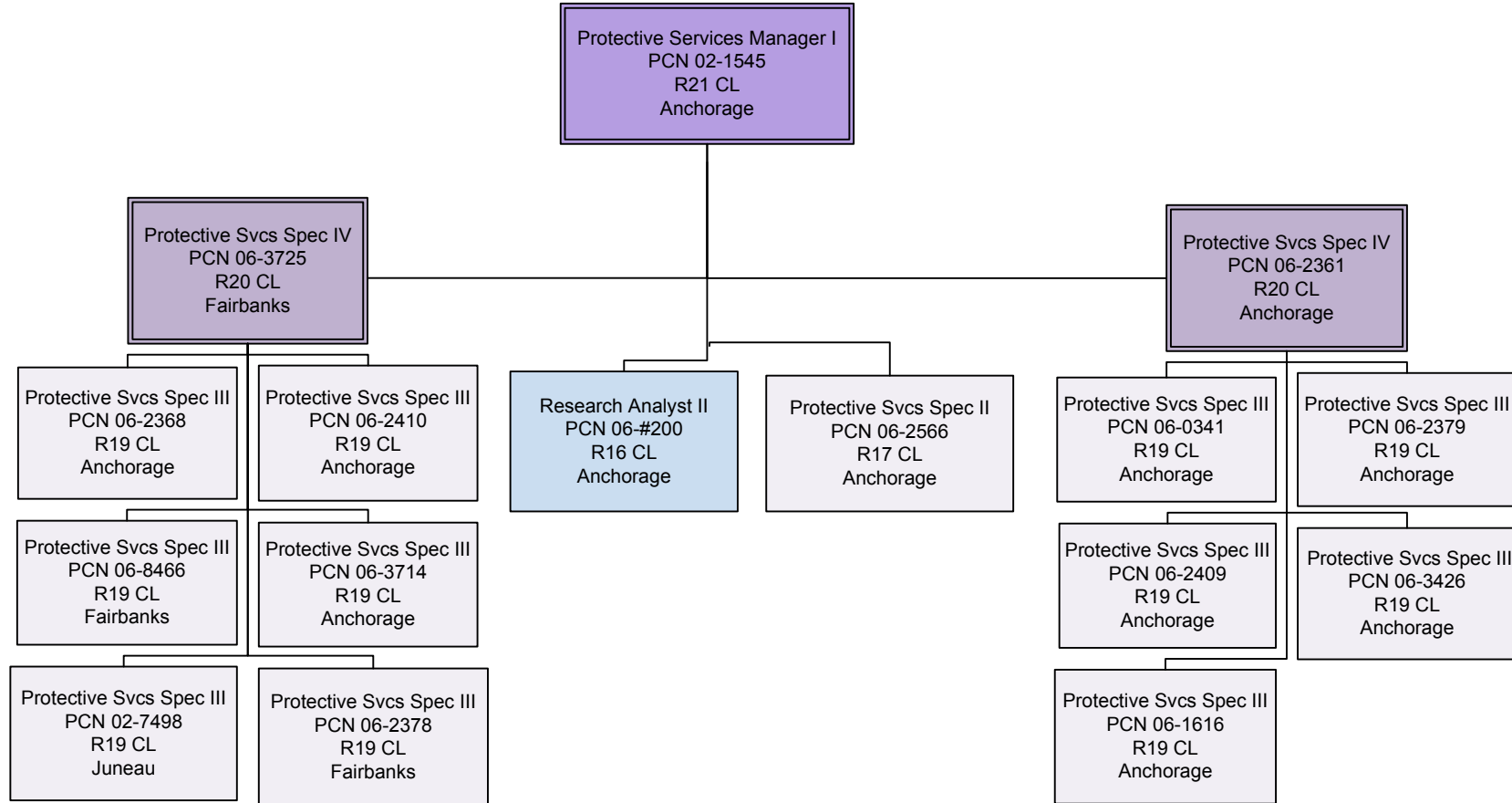

# Senior and Disabilities Services Automated Service Project

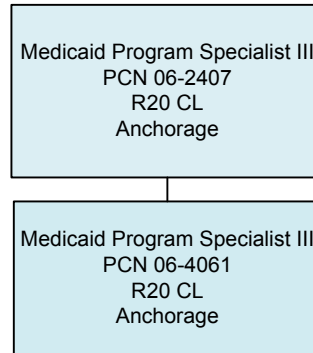

# Senior and Disabilities Services Central Intake

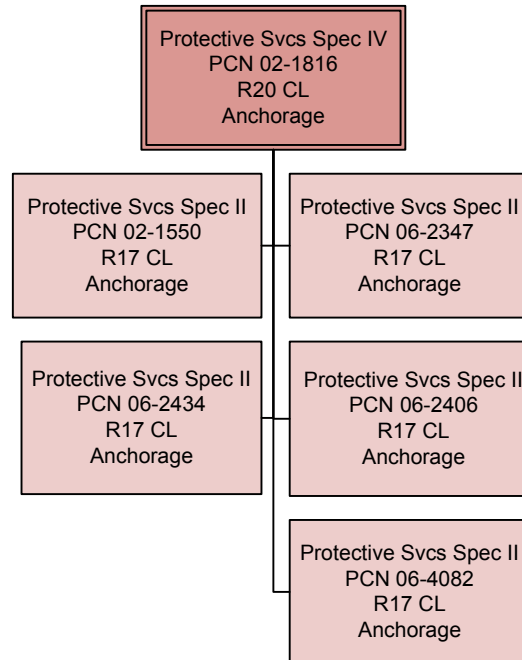

# Senior and Disabilities Services CAT Review Unit

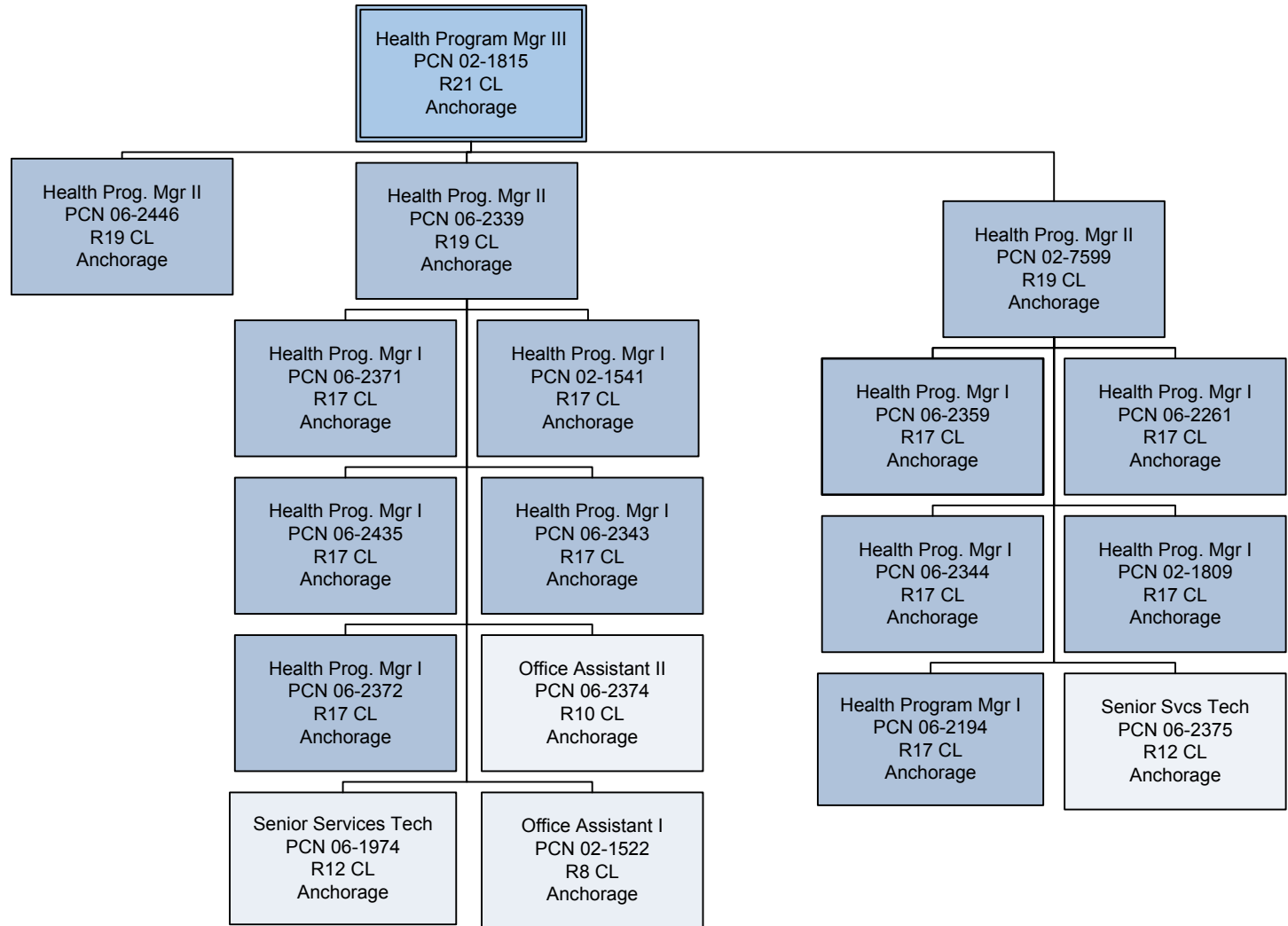

# Senior and Disabilities Services Assessment Unit

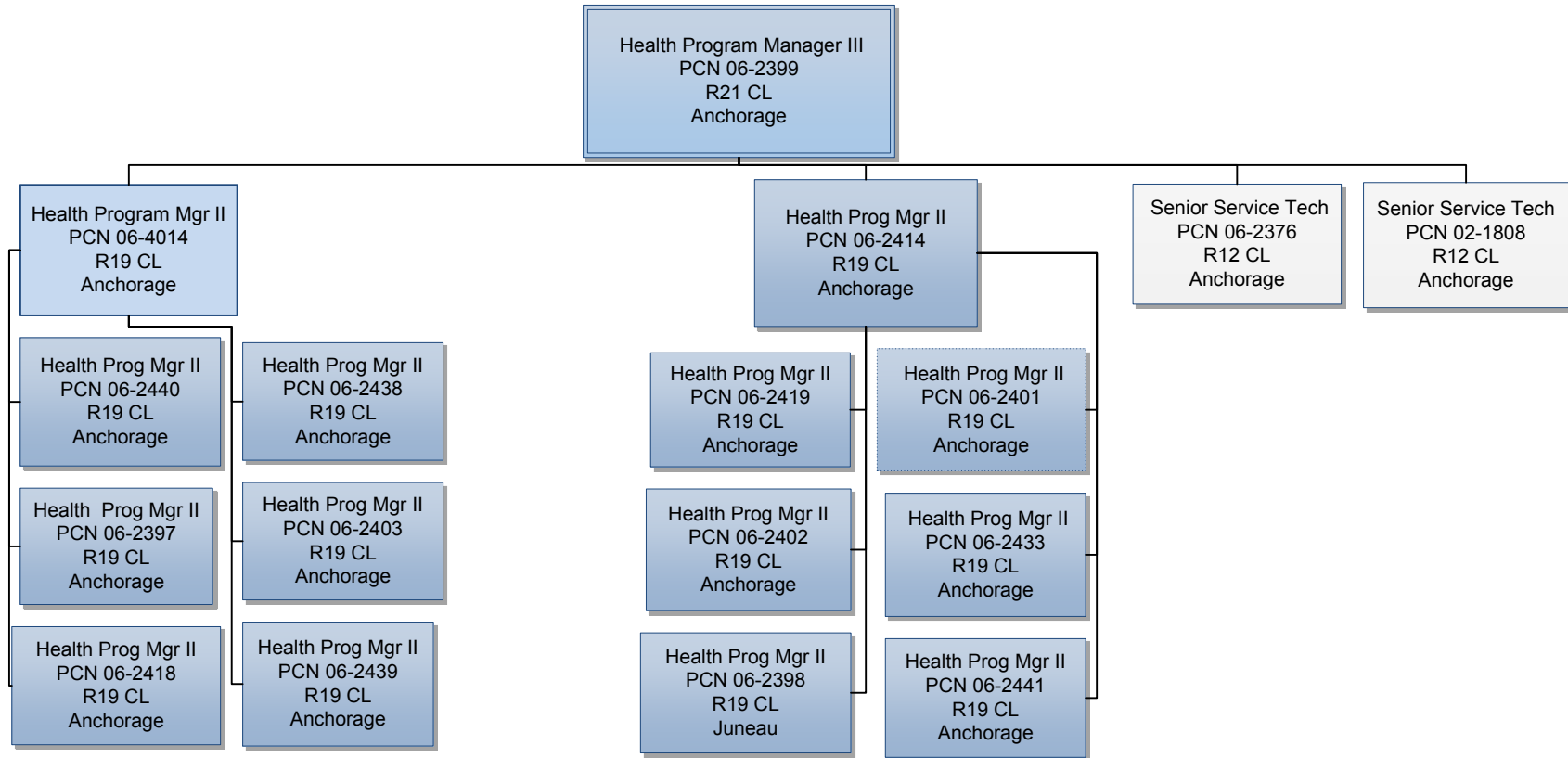

# Senior and Disabilities Services General Relief and Central Application Processing Unit

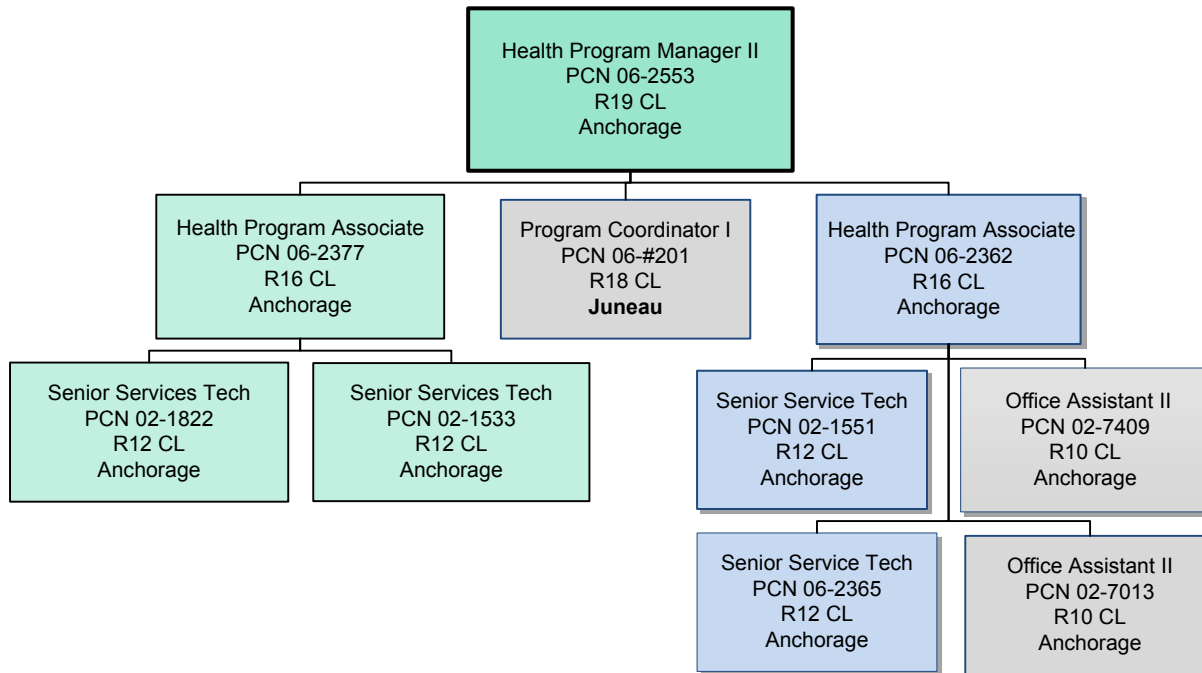



# Senior and Disabilities Services Intellectual & Developmental Disabilities Waiver Unit

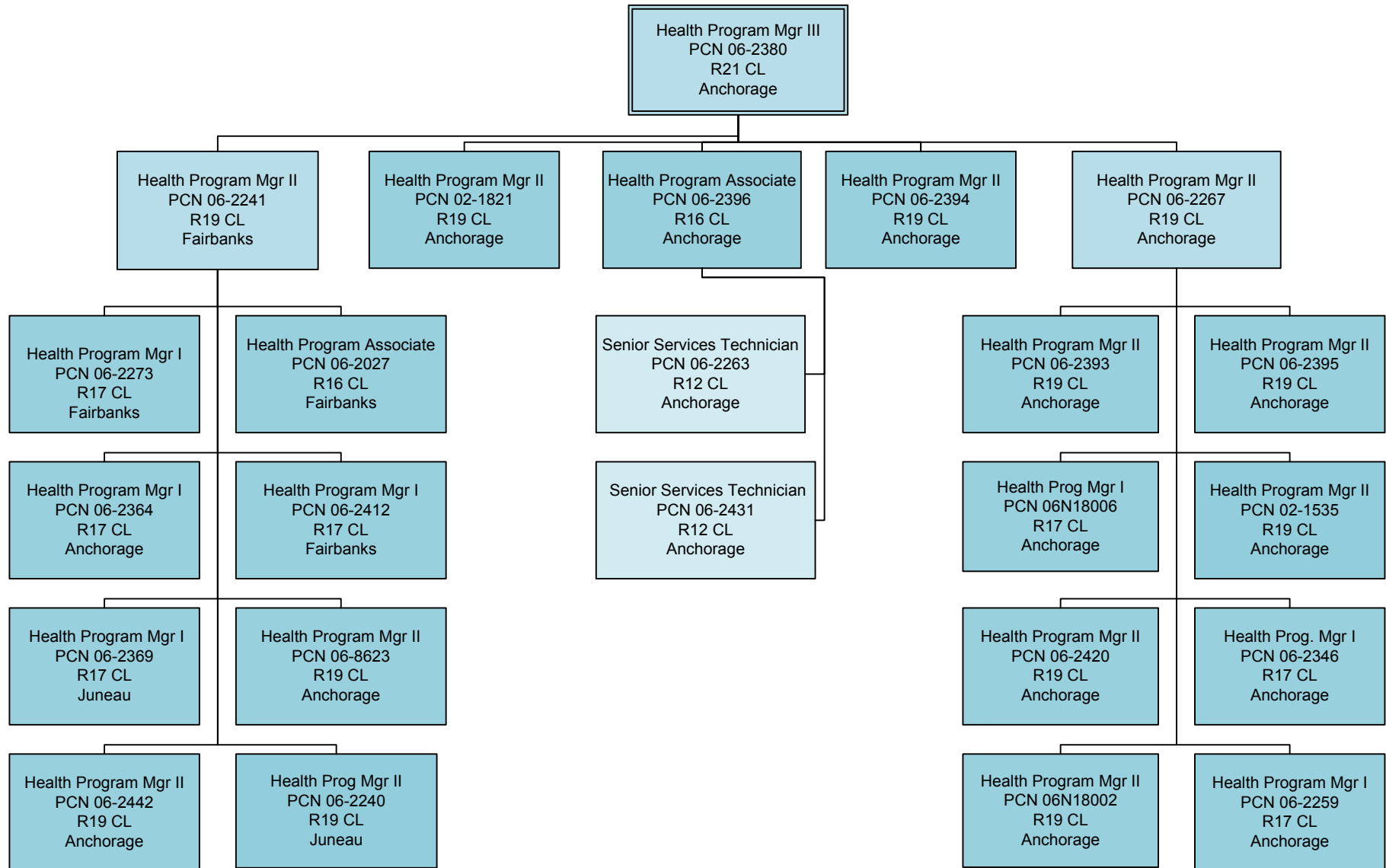

# Senior and Disabilities Services Infant Learning Program

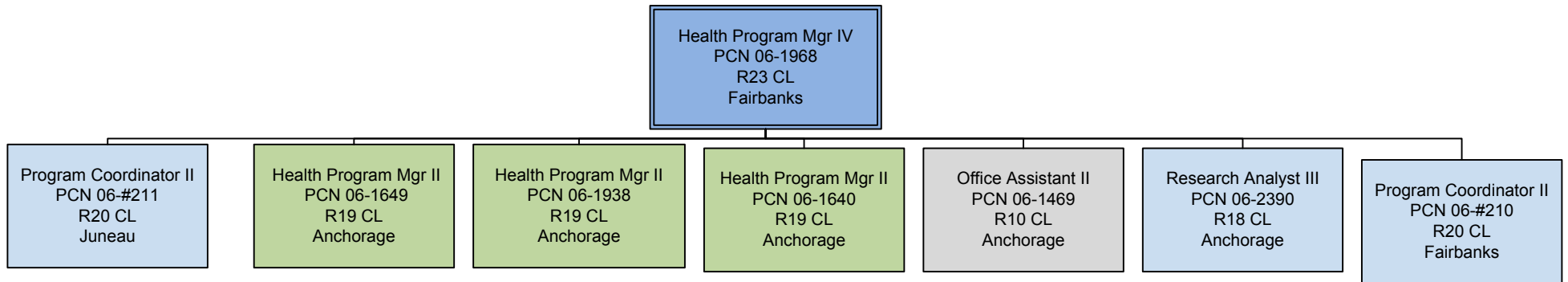

# Senior and Disabilities Services Training Unit

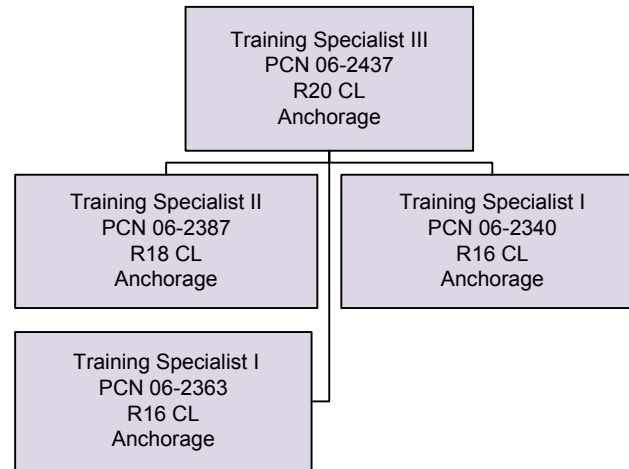

# Senior and Disabilities Services Nursing Unit

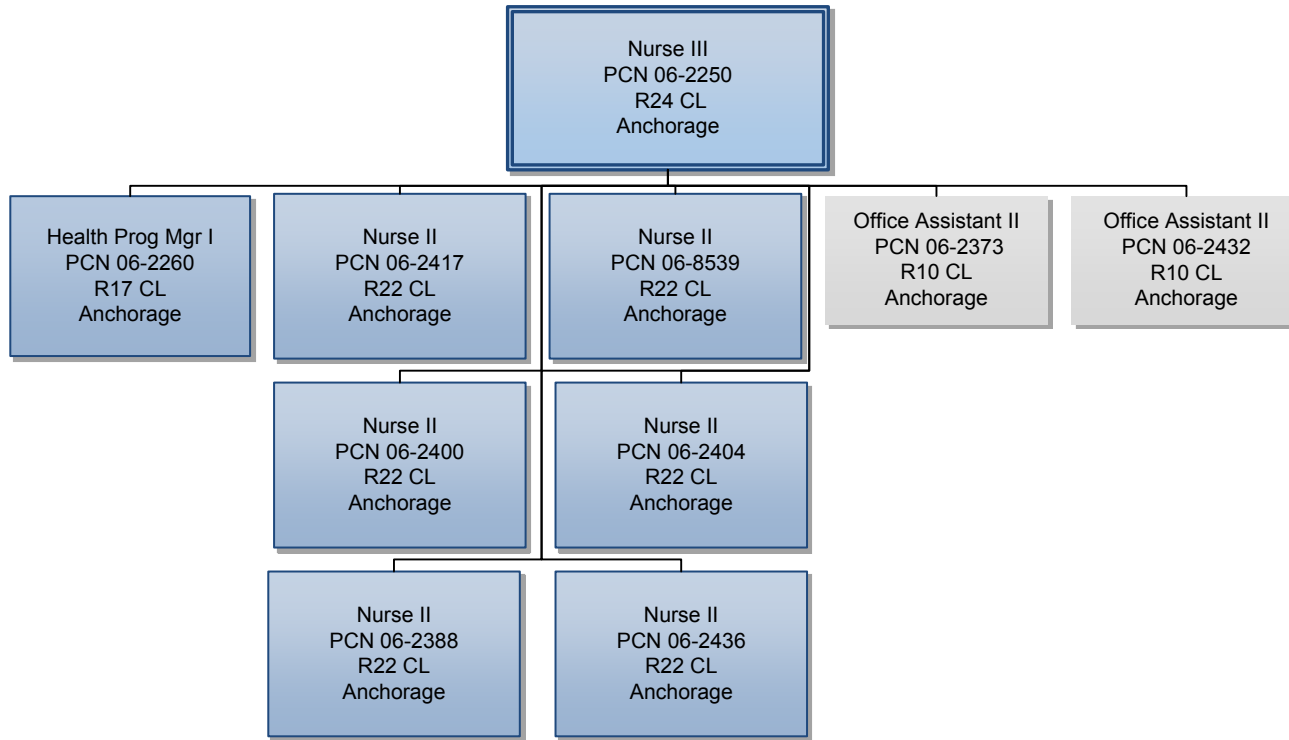

Senior and Disabilities Services  
Policy and Program Development Section

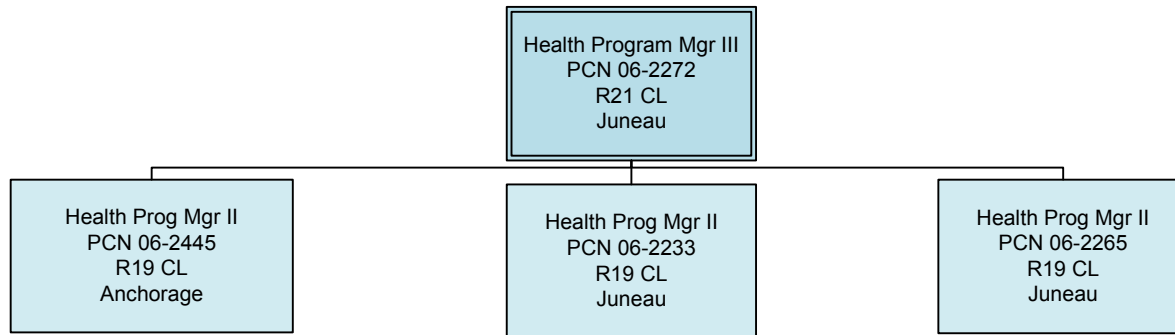

# Senior and Disabilities Services Provider Certification and Compliance

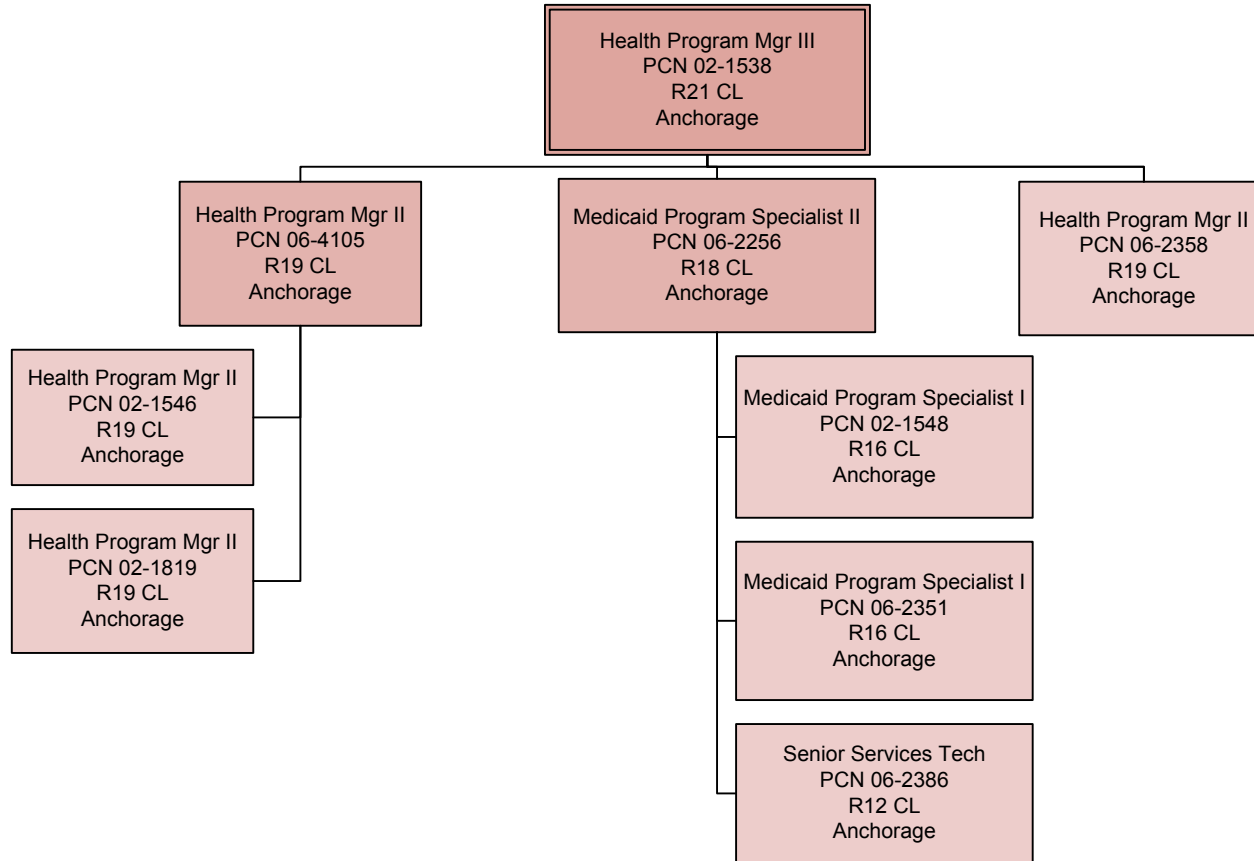

# Senior and Disabilities Services Quality Assurance / Fair Hearing

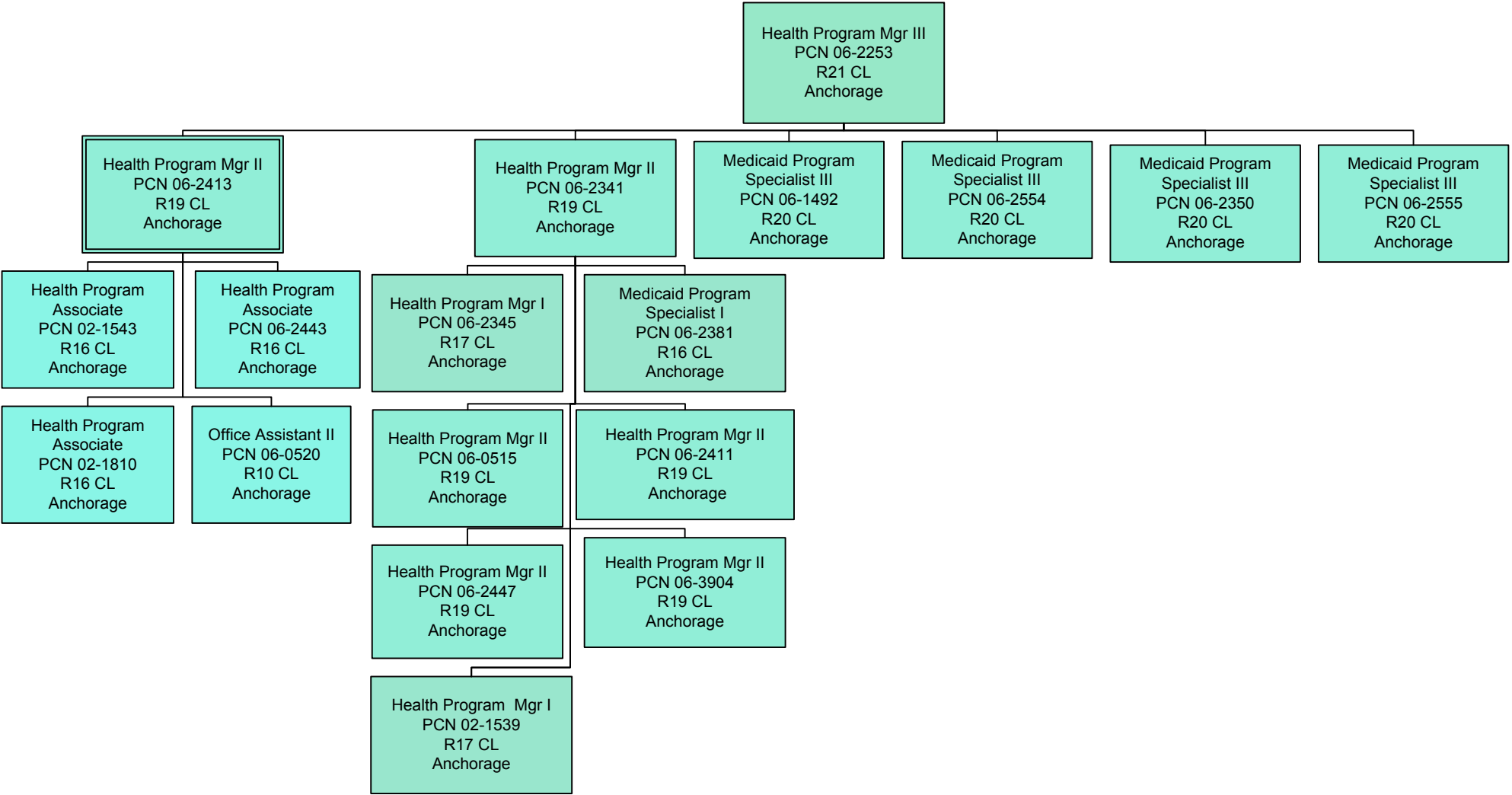

# Senior and Disabilities Services Research and Analysis Unit / Telehealth

