

State of Alaska FY2022 Governor's Operating Budget

Department of Administration Alaska Division of Information Technology RDU/Component Budget Summary

RDU/Component: Alaska Division of Information Technology

Contribution to Department's Mission

Provide a robust and secure information technology infrastructure together with enterprise services that support state agencies' business needs.

Results

(Additional performance information is available on the web at <https://omb.alaska.gov/results>.)

Core Services

- Secure and assure the integrity of state information, engineer secure solutions to benefit of the State, and respond appropriately to all security incidents to mitigate impact.
- Administration, management and maintenance of the state's enterprise IT infrastructure that includes the Wide Area Network (WAN), Mainframe computing platform, the SOA Private Cloud (the multi-tenant secure hosting platform), and facilities.
- Administration, management and support for Enterprise Applications: Messaging & Directory Services, Web Services including credit card processing, myAlaska, electronic signature, and SharePoint.
- End User Services - Service Desk Manager and WebHelpDesk ticketing systems; hardware deployment and demobilization; productivity tools training; software deployment; accounting provisioning and recovery.
- Core Telephony (JNU-ANC-FAI) Internet Protocol (IP) phone system; Mobile Device Management; Audio & Video conferencing; Secure Network Services; VPN; Internet & Wireless connectivity; and call center platform services.
- Service Level Agreement (SLA) Services: Provide metrics-driven performance data to its agency customers on a recurring basis to ensure performance goals are being achieved.

Measures by Core Service

(Additional performance information is available on the web at <https://omb.alaska.gov/results>.)

- 1. Secure and assure the integrity of state information, engineer secure solutions to benefit of the State, and respond appropriately to all security incidents to mitigate impact.**
- 2. Administration, management and maintenance of the state's enterprise IT infrastructure that includes the Wide Area Network (WAN), Mainframe computing platform, the SOA Private Cloud (the multi-tenant secure hosting platform), and facilities.**
- 3. Administration, management and support for Enterprise Applications: Messaging & Directory Services, Web Services including credit card processing, myAlaska, electronic signature, and SharePoint.**

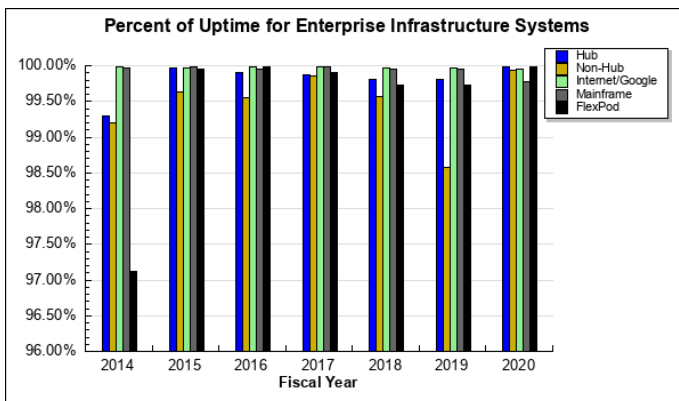

4. End User Services - Service Desk Manager and WebHelpDesk ticketing systems; hardware deployment and demobilization; productivity tools training; software deployment; accounting provisioning and recovery.

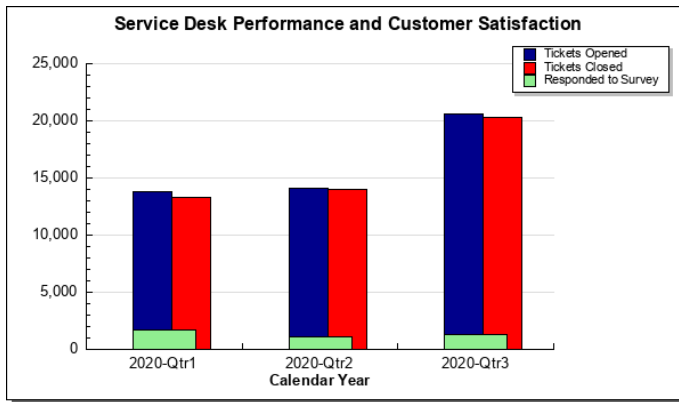

5. Core Telephony (JNU-ANC-FAI) Internet Protocol (IP) phone system; Mobile Device Management; Audio & Video conferencing; Secure Network Services; VPN; Internet & Wireless connectivity; and call center platform services.

6. Service Level Agreement (SLA) Services: Provide metrics-driven performance data to its agency customers on a recurring basis to ensure performance goals are being achieved.

Major Component Accomplishments in 2020

- Provided IT support through the COVID-19 pandemic, pivoting the SOA workforce to a telework environment, supporting up to 40% of the executive branch teleworking.
- Implemented enterprise Microsoft Teams product rollout to 8,000+ State employees to promote communication, collaboration, and remote work capabilities.
- Upgraded the State of Alaska’s Virtual Private Network (VPN) controllers. This increased the number of simultaneous connections from approximately 1,500 to about 20,000.
- As a modernization and cost reduction measure, OIT retired the Video Teleconferencing (VTC) service that is currently provided by GCI. Using existing licenses, OIT began leveraging the Microsoft Teams collaboration suite for video conferencing. This solution results in significant cost savings and provides State of Alaska (SOA) employees with a more versatile product.
- Coordinated three emergency laptop purchases (over 4,300 devices) for SOA departments to provide equipment and enable greater remote access for SOA employees.
- Completed the Alaska Administrative Productivity and Excellence (AAPEX) initiative to assess the effectiveness of current IT performance; define, design, and plan remaining IT improvements; and begin implementation of those plans to provide greater cost savings, consolidated services, and customer service.
- Implemented statewide IT Governance charter and committee as recommended by AAPEX to address statewide standards in IT architecture, equipment, security, services and new technologies.
- Executed Desktop Standardization project to increase efficiency and cost effectiveness in the purchase and life cycle management of desktop and laptop computers.
- Implemented the consolidated IT organization structure. Defined the target state OIT organization in terms of demand and critical responsibilities. Rationalized responsibilities, qualifications, duties and roles for IT professionals statewide.
- Updated chargeback cost pool structure to provide greater transparency of cost and allocations to departments.
- Implemented an enterprise electronic signature product (DocuSign), allowing the state to reduce dependence on circulating paper for approvals while increasing efficiency and remote work capability.
- Implemented new information security tools and planned the future information security roadmap as part of an ongoing effort to tighten our overall cybersecurity posture across the enterprise.

- Updated OIT Service Catalog identifying services offered/supported by OIT along with service level agreements (SLAs) for each.
- Migrated CSSD off the Mainframe, moving closer to being able to retire that equipment and its associated support cost.
- Implemented enterprise Azure landing zone to enable cloud migrations, modernization, improved security and availability of statewide applications and systems.
- Increased customers on the new Oracle cloud database solution with a goal of improving performance at a reduced cost for statewide systems and agency systems.
- Completed network upgrades that allow for dynamic routing of network traffic between core network locations. This changed the network configuration which allows the traffic to automatically re-route itself if there is an issue with one of the communication paths. As a part of the project we changed the network communication protocol from proprietary to vendor agnostic, enabling use of all makes of networking hardware rather than limited to just Cisco products, creating a more competitive sourcing environment.
- Continued Phase 2 of the Rural Bandwidth Initiative (RBI), which delivers improved internet and network access, at lower prices, to state and local government employees in rural locations around the state.
- Transitioned SATS/ALMR staff and services from OIT to the Division of Military and Veterans affairs.
- Continued to improve a centralized help desk incorporating customer satisfaction ratings and objective key performance indicators that provide increased transparency and accountability.

Key Component Challenges

An ongoing challenge for OIT remains the incomplete implementation of the IT consolidation, as mandated under Administrative Order 284. Many positions previously consolidated into OIT continue to perform functions for their old departments because there was no full reconciliation of IT roles and responsibilities. This gap is being addressed but needs to be completed. While OIT is taking steps to increase transparency to stakeholders, the rising costs associated with organizational growth is perceived as unsustainable by departments who have experienced reduced budgets and are paying for OIT costs and IT not yet transferred from their respective agencies.

Cloud adoption is a key challenge both in educating application and infrastructure teams how to use cloud services in a beneficial way as well as the cost and resources to assess and modernize aging state applications. Although CARES money was a jumpstart, additional partners, funding, and training will be needed over the next few years to assist the state in addressing the significant application support costs and improvements needed as identified in the AAPEX findings. Migration to the Cloud is essential in achieving security for the State, as well as attaining millions of dollars in cost savings.

Significant Changes in Results to be Delivered in FY2022

FY2022 will be a critical year for IT transformation. Cloud migration, maturing statewide IT governance and fiscal transparency, and completion of the consolidation envisioned in AO 284 are projected to come to fruition by the end of this period. The remainder of consolidation efforts will be driven by the deliverables provided as part of the Commissioner's Alaska Administrative Productivity and Excellence (AAPEX) initiative. Continued support of these efforts will be needed to achieve the intended benefits.

Statutory and Regulatory Authority

AS 44.21.020(9) (10)	Duties of Department
AS 44.21.045	Information Services Fund
AS 44.21.150-170	Automatic Data Processing
AS 44.21.305-390	Telecommunications
2 AAC 21	Information Services

Contact Information

Contact Information

Contact: Bill Smith, Chief Information Officer
Phone: (907) 465-2220
E-mail: bill.smith@alaska.gov

Alaska Division of Information Technology Personal Services Information				
Authorized Positions			Personal Services Costs	
	FY2021 Management Plan	FY2022 Governor		
Full-time	240	240	Annual Salaries	21,641,028
Part-time	0	0	COLA	181,095
Nonpermanent	0	0	Premium Pay	434,803
			Annual Benefits	12,072,380
			<i>Less 6.77% Vacancy Factor</i>	<i>(2,323,306)</i>
			Lump Sum Premium Pay	0
Totals	240	240	Total Personal Services	32,006,000

Position Classification Summary					
Job Class Title	Anchorage	Fairbanks	Juneau	Others	Total
Accountant II	0	0	1	0	1
Accountant IV	0	0	1	0	1
Accountant V	0	0	1	0	1
Accounting Technician II	0	0	1	0	1
Administrative Assistant II	0	0	1	0	1
Administrative Assistant III	1	0	1	0	2
Administrative Officer I	0	0	1	0	1
Administrative Officer II	1	0	0	0	1
Admn OPS Mgr II	0	0	1	0	1
Analyst/Programmer II	1	1	0	0	2
Analyst/Programmer III	2	0	0	0	2
Analyst/Programmer IV	8	0	0	0	8
Analyst/Programmer V	3	0	1	1	5
Chief Technology Officer I	1	0	0	0	1
Chief Technology Officer II	0	0	2	0	2
Chief Technology Officer III	2	0	0	0	2
Data Comm Sp I	1	1	0	0	2
Data Comm Sp II	5	0	2	0	7
Data Processing Manager I	8	1	6	0	15
Data Processing Manager II	1	0	1	0	2
Data Processing Manager III	2	0	0	0	2
Data Processing Technician II	2	0	6	0	8
Database Specialist II	0	0	3	0	3
Database Specialist III	1	0	3	0	4
Dep Chf Inf Ofc	1	0	0	0	1
Deputy Director	1	0	0	0	1
DP Prod Mgr	1	0	1	0	2
DPT Tech Ofc I	3	0	1	0	4
DPT Tech Ofc II	2	0	4	0	6
DPT Tech Ofcii	2	0	2	0	4
Internet Specialist II	1	0	1	0	2
Micro/Net Sp I	20	4	10	3	37
Micro/Net Sp II	10	4	7	1	22
Micro/Net Tc I	1	0	1	0	2
Micro/Net Tc II	22	0	8	0	30
Office Assistant II	0	0	1	0	1

Position Classification Summary					
Job Class Title	Anchorage	Fairbanks	Juneau	Others	Total
P3 Manager	2	0	1	0	3
Program Coordinator II	1	0	0	0	1
St Chf Inf Ofc	1	0	0	0	1
Systems Programmer I	2	0	4	0	6
Systems Programmer II	14	0	12	0	26
Systems Programmer III	9	0	5	0	14
Systems Programmer IV	1	0	0	0	1
Tech Arch Spec	0	0	1	0	1
Totals	133	11	91	5	240

Component Detail All Funds
Department of Administration

Component: Alaska Division of Information Technology (3141)
RDU: Office of Information Technology (653)

Non-Formula Component

	FY2020 Actuals	FY2021 Conference Committee	FY2021 Authorized	FY2021 Management Plan	FY2022 Governor	FY2021 Management Plan vs FY2022 Governor	
71000 Personal Services	27,641.7	31,071.7	31,071.7	31,071.7	32,006.0	934.3	3.0%
72000 Travel	35.4	84.9	84.9	84.9	84.9	0.0	0.0%
73000 Services	27,596.9	38,296.2	38,296.2	38,296.2	20,674.8	-17,621.4	-46.0%
74000 Commodities	1,602.9	395.3	395.3	395.3	1,005.4	610.1	154.3%
75000 Capital Outlay	4,048.6	1,954.9	1,954.9	1,954.9	3,000.0	1,045.1	53.5%
77000 Grants, Benefits	0.0	0.0	0.0	0.0	0.0	0.0	0.0%
78000 Miscellaneous	0.0	0.0	0.0	0.0	0.0	0.0	0.0%
Totals	60,925.5	71,803.0	71,803.0	71,803.0	56,771.1	-15,031.9	-20.9%
Fund Sources:							
1061 CIP Rcpts (Other)	499.4	0.0	0.0	0.0	0.0	0.0	0.0%
1081 Info Svc (Other)	60,426.1	71,803.0	71,803.0	71,803.0	56,771.1	-15,031.9	-20.9%
Unrestricted General (UGF)	0.0	0.0	0.0	0.0	0.0	0.0	0.0%
Designated General (DGF)	0.0	0.0	0.0	0.0	0.0	0.0	0.0%
Other Funds	60,925.5	71,803.0	71,803.0	71,803.0	56,771.1	-15,031.9	-20.9%
Federal Funds	0.0	0.0	0.0	0.0	0.0	0.0	0.0%
Positions:							
Permanent Full Time	251	236	236	240	240	0	0.0%
Permanent Part Time	1	1	1	0	0	0	0.0%
Non Permanent	0	0	0	0	0	0	0.0%

Change Record Detail - Multiple Scenarios with Descriptions
Department of Administration

Component: Alaska Division of Information Technology (3141)
RDU: Office of Information Technology (653)

Scenario/Change Record Title	Trans Type	Totals	Personal Services	Travel	Services	Commodities	Capital Outlay	Grants, Benefits	Miscellaneous	Positions		NP
										PFT	PPT	
***** Changes From FY2021 Conference Committee To FY2021 Authorized *****												
Conference Committee												
1081 Info Svc	ConfCom	71,803.0	31,071.7	84.9	38,296.2	395.3	1,954.9	0.0	0.0	236	1	0
		71,803.0										
	Subtotal	71,803.0	31,071.7	84.9	38,296.2	395.3	1,954.9	0.0	0.0	236	1	0
***** Changes From FY2021 Authorized To FY2021 Management Plan *****												
Change Micro Net Spec I (21-2050) from Part-Time to Full-Time for Workload Adjustment												
	PosAdj	0.0	0.0	0.0	0.0	0.0	0.0	0.0	0.0	1	-1	0
Change a part-time Micro Net Spec I (02-9513), range 18, located in Juneau, to full-time due to increased workload.												
Transfer Four Positions from Administrative Services for Department Reorganization Efforts												
	Trin	0.0	0.0	0.0	0.0	0.0	0.0	0.0	0.0	4	0	0
Transfer four positions from the Division of Administrative Services to the Office of Information Technology, Alaska Division of Information Technology for department reorganization efforts.												
The following positions are transferred from Administrative Services:												
Full-time Accounting Technician II (02-3115), range 14, located in Juneau												
Full-time Accountant II (02-6316), range 16, located in Juneau												
Full-time Accountant IV (02-3054), range 20, located in Juneau												
Full-time Accountant V (02-6307), range 22, located in Juneau												
Transfer Micro/Network Technician II (20-1088) to Goose Creek Correctional Facility to Meet Line of Business Needs												
	Atrot	0.0	0.0	0.0	0.0	0.0	0.0	0.0	0.0	-1	0	0
Transfer one position from the Office of Information Technology, Alaska Division of Information Technology back to the Department of Corrections Goose Creek Correctional Facility to meet line of business needs.												
The following position is transferred from The Alaska Division of Information Technology:												
Full-time Micro/Network Technician II (20-1088), range 16, located in Anchorage												
	Subtotal	71,803.0	31,071.7	84.9	38,296.2	395.3	1,954.9	0.0	0.0	240	0	0
***** Changes From FY2021 Management Plan To FY2022 Governor *****												
FY2022 Salary Adjustments												
1081 Info Svc	SalAdj	166.8	166.8	0.0	0.0	0.0	0.0	0.0	0.0	0	0	0
		166.8										

Change Record Detail - Multiple Scenarios with Descriptions
Department of Administration

Component: Alaska Division of Information Technology (3141)
RDU: Office of Information Technology (653)

Scenario/Change Record Title	Trans Type	Totals	Personal Services	Travel	Services	Commodities	Capital Outlay	Grants, Benefits	Miscellaneous	Positions		
										PFT	PPT	NP
FY2022 1% COLA for ASEA/General Government (GG/GP/GY/GZ): \$166.8												
Migrate to Microsoft G5 Through Realized Cost Savings												
	Dec	-1,250.0	0.0	0.0	-1,250.0	0.0	0.0	0.0	0.0	0	0	0
1081 Info Svc		-1,250.0										
Increasing licensing costs will allow the State of Alaska to transition to a more comprehensive suite of capabilities. These capabilities are essential for maintaining the telework infrastructure that is allowing the State of Alaska to keep its workforce safe and maintain continuity of government operations during COVID-19. This increase in Microsoft G5 licensing enables Office of Information Technology (OIT) to replace several existing systems, reducing total cost of operations and increasing capabilities. It includes licensing for Teams phones which is required to migrate to software phones and retirement of the legacy desk phone contract. Also included are security capabilities that will allow retirement of the Evotek security systems and other security platforms. OIT will achieve additional cost reductions through core contract savings. The licensing cost increase and the associated cost savings measures lead to an overall reduction.												
Reduce Authority to Realize Space Consolidation Savings Due to Telework												
	Dec	-200.0	0.0	0.0	-200.0	0.0	0.0	0.0	0.0	0	0	0
1081 Info Svc		-200.0										
The Bayview lease ends at the end of June 2021. The Office of Information Technology has a plan to relocate these staff by using a combination of shared space in the Atwood Building with a routine telework model.												
Reduction in Parking for Increased Teleworking												
	Dec	-10.0	0.0	0.0	-10.0	0.0	0.0	0.0	0.0	0	0	0
1081 Info Svc		-10.0										
The Office of Information Technology (OIT) plans to increase teleworking in the Atwood building, which will reduce parking costs.												
Transfer Channel Drive Lease to Department of Military and Veterans Affairs												
	Dec	-58.0	0.0	0.0	-58.0	0.0	0.0	0.0	0.0	0	0	0
1081 Info Svc		-58.0										
The Office of Information Technology will no longer be paying for this lease with the transfer of State of Alaska Telecommunication System facilities move to Department of Military and Veterans Affairs.												
Align Authority with Anticipated Central Services Revenue												
	Dec	-13,680.7	0.0	0.0	-13,680.7	0.0	0.0	0.0	0.0	0	0	0
1081 Info Svc		-13,680.7										
Align budget authority with anticipated revenue based on current fiscal year approved central services cost allocation rates for information technology services provided by the Office of Information Technology (OIT).												

Change Record Detail - Multiple Scenarios with Descriptions
Department of Administration

Component: Alaska Division of Information Technology (3141)
RDU: Office of Information Technology (653)

Scenario/Change Record Title	Trans Type	Totals	Personal Services	Travel	Services	Commodities	Capital Outlay	Grants, Benefits	Miscellaneous	Positions		
										PFT	PPT	NP
Budget authority was increased in OIT based on anticipated costs to implement Administrative Order 284, the centralization of all telecommunication and information technology services to state agencies. Actual costs are lower than originally anticipated, partly due to efficiency gains and cost savings achieved in OIT as departments continue to onboard, which has resulted in a higher level of budget authority than necessary.												
Transfer Services Authority to Align with Expenditures	LIT	0.0	767.5	0.0	-2,422.7	610.1	1,045.1	0.0	0.0	0	0	0
Transfer authority from services to cover anticipated personal services, commodities, and capital outlay costs. The remaining services authority is sufficient to cover anticipated expenditures.												
Totals		56,771.1	32,006.0	84.9	20,674.8	1,005.4	3,000.0	0.0	0.0	240	0	0

Line Item Detail (1676)
Department of Administration
Travel

Component: Alaska Division of Information Technology (3141)

Line Number	Line Name		FY2020 Actuals	FY2021 Management Plan	FY2022 Governor
2000	Travel		35.4	84.9	84.9
Object Class	Servicing Agency	Explanation	FY2020 Actuals	FY2021 Management Plan	FY2022 Governor
2000 Travel Detail Totals			35.4	84.9	84.9
2000	In-State Employee Travel	Transportation costs for travel relating to administration, training, conventions and meetings, boards and commissions	21.7	83.9	83.9
2001	In-State Non-Employee Travel	Transportation costs for travel relating to meetings and boards for non-employees	1.2	0.0	0.0
2002	Out of State Employee Travel	Transportation costs for staff travel out of state to national organization meetings, conferences, and training	0.0	1.0	1.0
2005	Moving Costs	Moving and relocation costs	12.5	0.0	0.0

Line Item Detail (1676)
Department of Administration
Services

Component: Alaska Division of Information Technology (3141)

Line Number	Line Name		FY2020 Actuals	FY2021 Management Plan	FY2022 Governor
3000	Services		27,596.9	38,296.2	20,674.8
Object Class	Servicing Agency	Explanation	FY2020 Actuals	FY2021 Management Plan	FY2022 Governor
3000 Services Detail Totals			27,596.9	38,296.2	20,674.8
3000	Education Services	Training, educational conferences, agency memberships, and employee tuition	161.7	161.7	150.0
3001	Financial Services	Management and consulting services	25.6	185.0	185.0
3003	Information Technology	Software licensing and maintenance, training, and consulting	16,229.7	27,970.3	11,340.0
3004	Telecommunications	Local, long distance, and cellular telephone charges, television, data/network, telecommunication equipment, and other wireless charges from outside vendors	4,305.5	5,500.0	5,500.0
3006	Delivery Services	Freight, courier services, and postage	11.3	18.0	16.0
3008	Utilities	Electricity, heating fuel, water, sewage and disposal services	2.8	6.0	6.0
3009	Structure/Infrastructure/Land	Structure, infrastructure and land repairs, maintenance, rental, and leases	128.1	200.0	150.0
3010	Equipment/Machinery	Machinery, furniture and office equipment purchase, repairs, maintenance, rentals, and leases	458.6	500.0	500.0
3011	Other Services	Management/consulting fees; printing, copying & graphic services; safety services	210.0	210.0	210.0
3020	Inter-Agency Building Maintenance	Trans - Department-wide Building maintenance services	24.8	25.0	25.0

Line Item Detail (1676)
Department of Administration
Services

Component: Alaska Division of Information Technology (3141)

Object Class		Servicing Agency	Explanation	FY2020 Actuals	FY2021 Management Plan	FY2022 Governor
3000 Services Detail Totals				27,596.9	38,296.2	20,674.8
3021	Inter-Agency Mail	Admin - Print Services (2333)	Centralized mail services chargeback	4.1	5.0	5.0
3022	Inter-Agency Human Resources	Admin - Administrative Services (46)	HR Consultant	97.2	100.0	100.0
3022	Inter-Agency Human Resources	Admin - Personnel (56)	Human resource and payroll services provided by the Division of Personnel	156.1	200.0	156.1
3022	Inter-Agency Human Resources	Admin - Personnel (56)	Classification Position	56.3	90.0	0.0
3023	Inter-Agency Building Leases	Admin - Facilities (2429)	Rent for state-owned facilities and lease payments	666.0	776.0	700.0
3023	Inter-Agency Building Leases	Admin - Facilities Administration (2430)	Rent for state-owned facilities and lease payments	29.0	29.0	29.0
3023	Inter-Agency Building Leases	Admin - Leases (81)	Rent for state-owned facilities and lease payments	253.0	320.0	320.0
3026	Inter-Agency Insurance	Admin - Risk Management (71)	Division of Risk Management - Risk management insurance charges	20.3	20.3	20.3
3027	Inter-Agency Financial	Admin - Accounting (3134)	SSoA Accounts Payable, Travel, and AAPEX Chargeback	50.3	50.3	50.3
3027	Inter-Agency Financial	Admin - Finance (59)	Division of Finance Chargeback for IRIS FIN, HRM, and ALDER	13.8	13.8	13.8
3028	Inter-Agency Americans with Disabilities Act Compliance	Admin - Personnel (56)	Americans with Disabilities Act (ADA) Chargeback	1.9	1.9	1.9
3031	Inter-Agency Construction			7.5	0.0	0.0
3037	State Equipment Fleet	Trans - Department-wide	State equipment fleet chargeback for vehicle lease, maintenance, and fuel	21.2	21.2	21.2
3038	Inter-Agency Management/Consulting	Admin - Administrative Services (46)	Support services provided by the Division of Administrative Services	442.9	443.1	442.9
3038	Inter-Agency Management/Consulting	Admin - Facilities (2429)	Electrical consumption costs	122.6	122.6	122.6
3038	Inter-Agency Management/Consulting	Admin - Motor Vehicles (2348)	State Employee ID costs	0.1	0.5	0.5

Line Item Detail (1676)
Department of Administration
Services

Component: Alaska Division of Information Technology (3141)

Object Class	Servicing Agency	Explanation	FY2020 Actuals	FY2021 Management Plan	FY2022 Governor	
3000 Services Detail Totals			27,596.9	38,296.2	20,674.8	
3038	Inter-Agency Management/Consulting	Admin - Office of the Commissioner (45)	Support services provided by the Office of the Commissioner	349.0	200.0	200.0
3038	Inter-Agency Management/Consulting	Admin - Stwd Contracting and Property (3262)	SSoA Procurement Chargeback	403.7	403.7	403.7
3038	Inter-Agency Management/Consulting	Rev - Department-wide	Trustwave services	4.1	5.0	5.5
3038	Inter-Agency Management/Consulting	Admin - Administrative Services (46)	OIT Accounting services	342.8	0.0	0.0
3038	Inter-Agency Management/Consulting	Admin - Office of the Commissioner (45)	AAPEX Restructure Contract	2,996.9	717.8	0.0

Line Item Detail (1676)
Department of Administration
Commodities

Component: Alaska Division of Information Technology (3141)

Line Number	Line Name		FY2020 Actuals	FY2021 Management Plan	FY2022 Governor
4000	Commodities		1,602.9	395.3	1,005.4
Object Class	Servicing Agency	Explanation	FY2020 Actuals	FY2021 Management Plan	FY2022 Governor
4000 Commodities Detail Totals			1,602.9	395.3	1,005.4
4000	Business	General business supplies such as office consumables, furniture, and computer equipment	1,599.2	387.3	997.4
4002	Household/Institutional	Cleaning, food and other household supplies	2.6	2.6	2.6
4015	Parts and Supplies	Parts, supplies, maintenance and repair items	1.0	5.4	5.4
4019	Small Tools/Minor Equipment	Maintenance and repair tools and small equipment	0.1	0.0	0.0

Line Item Detail (1676)
Department of Administration
Capital Outlay

Component: Alaska Division of Information Technology (3141)

Line Number	Line Name		FY2020 Actuals	FY2021 Management Plan	FY2022 Governor
5000	Capital Outlay		4,048.6	1,954.9	3,000.0
Object Class	Servicing Agency	Explanation	FY2020 Actuals	FY2021 Management Plan	FY2022 Governor
5000 Capital Outlay Detail Totals			4,048.6	1,954.9	3,000.0
5004	Equipment	Equipment costs	4,048.6	1,954.9	3,000.0

Revenue Detail (1681)
Department of Administration

Component: Alaska Division of Information Technology (3141)

Revenue Type (OMB Fund Code) Revenue Source	Component	Comment	FY2020 Actuals	FY2021 Management Plan	FY2022 Governor
5061 CIP Rcpts (1061 CIP Rcpts)			499.4	0.0	0.0
5351 Capital Improvement Project Inter-Agency			499.4	0.0	0.0
6081 Info Svc (1081 Info Svc)			54,700.7	71,803.0	56,771.1
6654 Information Services Fund Statutory Operating I/A Rec		Public Records Request	1.4	1.4	1.4
6654 Information Services Fund Statutory Operating I/A Rec	Admin - Accounting (3134)	OIT Core Services (includes Adobe Pro and Microsoft 365 as well as services previously provided under the Telecommunications and Computer Services EPR)	222.7	250.0	222.7
6654 Information Services Fund Statutory Operating I/A Rec	Admin - Administrative Hearings (2771)	OIT Core Services (includes Adobe Pro and Microsoft 365 as well as services previously provided under the Telecommunications and Computer Services EPR)	47.5	84.4	47.5
6654 Information Services Fund Statutory Operating I/A Rec	Admin - Administrative Services (46)	OIT Core Services (includes Adobe Pro and Microsoft 365 as well as services previously provided under the Telecommunications and Computer Services EPR)	44.5	72.6	44.5
6654 Information Services Fund Statutory Operating I/A Rec	Admin - Alaska Public Offices Comm (70)	OIT Core Services (includes Adobe Pro and Microsoft 365 as well as services previously provided under the Telecommunications and Computer Services EPR)	23.8	52.2	23.8
6654 Information Services Fund Statutory Operating I/A Rec	Admin - E-Travel (2966)	OIT Core Services (includes Adobe Pro and Microsoft 365 as well as services previously provided under the Telecommunications and Computer Services EPR)	3.0	9.2	3.0
6654 Information Services Fund Statutory Operating I/A Rec	Admin - Facilities (2429)	OIT Telecommunications (CISCO device config, deployment, maintenance, and replacements)	13.3	90.0	13.3
6654 Information Services Fund Statutory	Admin - Facilities Administration	OIT Core Services (includes Adobe	26.7	42.5	26.7

Revenue Detail (1681)
Department of Administration

Component: Alaska Division of Information Technology (3141)

Revenue Type (OMB Fund Code) Revenue Source	Component	Comment	FY2020 Actuals	FY2021 Management Plan	FY2022 Governor
Operating I/A Rec	(2430)	Pro and Microsoft 365 as well as services previously provided under the Telecommunications and Computer Services EPR)			
6654 Information Services Fund Statutory Operating I/A Rec	Admin - Finance (59)	OIT Core Services (includes Adobe Pro and Microsoft 365 as well as services previously provided under the Telecommunications and Computer Services EPR)	148.4	150.0	148.4
6654 Information Services Fund Statutory Operating I/A Rec	Admin - Labor Relations (58)	OIT Core Services (includes Adobe Pro and Microsoft 365 as well as services previously provided under the Telecommunications and Computer Services EPR)	20.8	20.8	20.8
6654 Information Services Fund Statutory Operating I/A Rec	Admin - Lease Administration (2304)	OIT Core Services (includes Adobe Pro and Microsoft 365 as well as services previously provided under the Telecommunications and Computer Services EPR)	32.7	50.0	32.7
6654 Information Services Fund Statutory Operating I/A Rec	Admin - Motor Vehicles (2348)	OIT Core Services (includes Adobe Pro and Microsoft 365 as well as services previously provided under the Telecommunications and Computer Services EPR)	424.5	590.0	424.5
6654 Information Services Fund Statutory Operating I/A Rec	Admin - Office of Public Advocacy (43)	OIT Core Services (includes Adobe Pro and Microsoft 365 as well as services previously provided under the Telecommunications and Computer Services EPR)	472.0	472.0	472.0
6654 Information Services Fund Statutory Operating I/A Rec	Admin - Office of the Commissioner (45)	OIT Core Services (includes Adobe Pro and Microsoft 365 as well as services previously provided under the Telecommunications and Computer Services EPR)	17.8	32.0	17.8
6654 Information Services Fund Statutory Operating I/A Rec	Admin - Personnel (56)	OIT Core Services (includes Adobe Pro and Microsoft 365 as well as services previously provided under	356.3	500.0	356.3

Revenue Detail (1681)
Department of Administration

Component: Alaska Division of Information Technology (3141)

Revenue Type (OMB Fund Code) Revenue Source	Component	Comment	FY2020 Actuals	FY2021 Management Plan	FY2022 Governor
6654 Information Services Fund Statutory Operating I/A Rec	Admin - Print Services (2333)	the Telecommunications and Computer Services EPR) OIT Core Services (includes Adobe Pro and Microsoft 365 as well as services previously provided under the Telecommunications and Computer Services EPR)	14.8	30.0	14.8
6654 Information Services Fund Statutory Operating I/A Rec	Admin - Public Defender Agency (1631)	OIT Core Services (includes Adobe Pro and Microsoft 365 as well as services previously provided under the Telecommunications and Computer Services EPR)	556.7	680.0	556.7
6654 Information Services Fund Statutory Operating I/A Rec	Admin - Retirement and Benefits (64)	OIT Core Services (includes Adobe Pro and Microsoft 365 as well as services previously provided under the Telecommunications and Computer Services EPR)	378.5	665.6	378.5
6654 Information Services Fund Statutory Operating I/A Rec	Admin - Risk Management (71)	OIT Core Services (includes Adobe Pro and Microsoft 365 as well as services previously provided under the Telecommunications and Computer Services EPR)	17.8	22.4	17.8
6654 Information Services Fund Statutory Operating I/A Rec	Admin - Stwd Contracting and Property (3262)	OIT Core Services (includes Adobe Pro and Microsoft 365 as well as services previously provided under the Telecommunications and Computer Services EPR)	50.5	62.0	50.5
6654 Information Services Fund Statutory Operating I/A Rec	Admin - Violent Crimes Comp Board (2694)	OIT Core Services (includes Adobe Pro and Microsoft 365 as well as services previously provided under the Telecommunications and Computer Services EPR)	8.9	15.8	8.9
6654 Information Services Fund Statutory Operating I/A Rec	Commerce - Department-wide	OIT Core Services (includes Adobe Pro and Microsoft 365 as well as services previously provided under the Telecommunications and Computer Services EPR)	1,500.4	1,900.0	1,500.4

Revenue Detail (1681)
Department of Administration

Component: Alaska Division of Information Technology (3141)

Revenue Type (OMB Fund Code) Revenue Source	Component	Comment	FY2020 Actuals	FY2021 Management Plan	FY2022 Governor
6654 Information Services Fund Statutory Operating I/A Rec	Correct - Department-wide	OIT Core Services (includes Adobe Pro and Microsoft 365 as well as services previously provided under the Telecommunications and Computer Services EPR)	3,457.1	4,500.0	3,457.1
6654 Information Services Fund Statutory Operating I/A Rec	Courts - Department-wide	OIT Core Services (includes Adobe Pro and Microsoft 365 as well as services previously provided under the Telecommunications and Computer Services EPR)	23.6	30.0	23.6
6654 Information Services Fund Statutory Operating I/A Rec	E&ED - Department-wide	OIT Core Services (includes Adobe Pro and Microsoft 365 as well as services previously provided under the Telecommunications and Computer Services EPR)	682.3	1,100.0	682.3
6654 Information Services Fund Statutory Operating I/A Rec	EnvCon - Department-wide	OIT Core Services (includes Adobe Pro and Microsoft 365 as well as services previously provided under the Telecommunications and Computer Services EPR)	1,423.6	1,914.1	1,423.6
6654 Information Services Fund Statutory Operating I/A Rec	FishGm - Department-wide	OIT Core Services (includes Adobe Pro and Microsoft 365 as well as services previously provided under the Telecommunications and Computer Services EPR)	3,056.9	4,200.0	3,056.9
6654 Information Services Fund Statutory Operating I/A Rec	Gov - Department-wide	OIT Core Services (includes Adobe Pro and Microsoft 365 as well as services previously provided under the Telecommunications and Computer Services EPR)	443.0	510.0	443.0
6654 Information Services Fund Statutory Operating I/A Rec	H&SS - Department-wide	OIT Core Services (includes Adobe Pro and Microsoft 365 as well as services previously provided under the Telecommunications and Computer Services EPR)	8,736.6	13,000.0	8,736.6
6654 Information Services Fund Statutory Operating I/A Rec	Labor - Department-wide	OIT Core Services (includes Adobe Pro and Microsoft 365 as well as	1,804.6	2,300.0	1,804.6

Revenue Detail (1681)
Department of Administration

Component: Alaska Division of Information Technology (3141)

Revenue Type (OMB Fund Code) Revenue Source	Component	Comment	FY2020 Actuals	FY2021 Management Plan	FY2022 Governor
6654 Information Services Fund Statutory Operating I/A Rec	Law - Department-wide	services previously provided under the Telecommunications and Computer Services EPR) OIT Core Services (includes Adobe Pro and Microsoft 365 as well as services previously provided under the Telecommunications and Computer Services EPR)	1,547.7	2,100.0	1,547.7
6654 Information Services Fund Statutory Operating I/A Rec	Legis - Department-wide	OIT Core Services (includes Adobe Pro and Microsoft 365 as well as services previously provided under the Telecommunications and Computer Services EPR)	404.6	600.0	404.6
6654 Information Services Fund Statutory Operating I/A Rec	M&VA - Department-wide	OIT Core Services (includes Adobe Pro and Microsoft 365 as well as services previously provided under the Telecommunications and Computer Services EPR)	726.6	900.0	726.6
6654 Information Services Fund Statutory Operating I/A Rec	NatRes - Department-wide	OIT Core Services (includes Adobe Pro and Microsoft 365 as well as services previously provided under the Telecommunications and Computer Services EPR)	2,040.9	2,500.0	2,040.9
6654 Information Services Fund Statutory Operating I/A Rec	PubSaf - Department-wide	OIT Core Services (includes Adobe Pro and Microsoft 365 as well as services previously provided under the Telecommunications and Computer Services EPR)	2,410.1	3,500.0	2,410.1
6654 Information Services Fund Statutory Operating I/A Rec	Rev - Department-wide	OIT Core Services (includes Adobe Pro and Microsoft 365 as well as services previously provided under the Telecommunications and Computer Services EPR)	1,411.8	2,400.0	1,411.8
6654 Information Services Fund Statutory Operating I/A Rec	Trans - Department-wide	OIT Core Services (includes Adobe Pro and Microsoft 365 as well as services previously provided under the Telecommunications and	5,470.0	8,136.4	6,830.7

Revenue Detail (1681)
Department of Administration

Component: Alaska Division of Information Technology (3141)

Revenue Type (OMB Fund Code) Revenue Source	Component	Comment	FY2020 Actuals	FY2021 Management Plan	FY2022 Governor
6654 Information Services Fund Statutory Operating I/A Rec	Admin - Accounting (3134)	Computer Services EPR) OIT Telecommunications (CISCO device config, deployment, maintenance, and replacements)	20.7	20.7	20.7
6654 Information Services Fund Statutory Operating I/A Rec	Admin - Administrative Hearings (2771)	OIT Telecommunications (CISCO device config, deployment, maintenance, and replacements)	8.4	8.4	8.4
6654 Information Services Fund Statutory Operating I/A Rec	Admin - Administrative Services (46)	OIT Telecommunications (CISCO device config, deployment, maintenance, and replacements)	7.6	7.6	7.6
6654 Information Services Fund Statutory Operating I/A Rec	Admin - Alaska Public Offices Comm (70)	OIT Telecommunications (CISCO device config, deployment, maintenance, and replacements)	0.7	0.7	0.7
6654 Information Services Fund Statutory Operating I/A Rec	Admin - Facilities (2429)	OIT Server Hosting and Storage	2.8	2.8	2.8
6654 Information Services Fund Statutory Operating I/A Rec	Admin - Facilities Administration (2430)	OIT Telecommunications (CISCO device config, deployment, maintenance, and replacements)	3.0	3.0	3.0
6654 Information Services Fund Statutory Operating I/A Rec	Admin - Finance (59)	OIT Telecommunications (CISCO device config, deployment, maintenance, and replacements)	18.9	18.9	18.9
6654 Information Services Fund Statutory Operating I/A Rec	Admin - Labor Relations (58)	OIT Telecommunications (CISCO device config, deployment, maintenance, and replacements)	4.8	4.8	4.8
6654 Information Services Fund Statutory Operating I/A Rec	Admin - Lease Administration (2304)	OIT Telecommunications (CISCO device config, deployment, maintenance, and replacements)	4.7	4.7	4.7
6654 Information Services Fund Statutory Operating I/A Rec	Admin - Motor Vehicles (2348)	OIT Telecommunications (CISCO device config, deployment, maintenance, and replacements)	43.2	43.2	43.2
6654 Information Services Fund Statutory Operating I/A Rec	Admin - Office of Public Advocacy (43)	OIT Telecommunications (CISCO device config, deployment, maintenance, and replacements)	63.8	63.8	63.8
6654 Information Services Fund Statutory Operating I/A Rec	Admin - Office of the Commissioner (45)	OIT Telecommunications (CISCO device config, deployment, maintenance, and replacements)	6.4	6.4	6.4
6654 Information Services Fund Statutory	Admin - Personnel (56)	OIT Telecommunications (CISCO	55.5	55.5	55.5

Revenue Detail (1681)
Department of Administration

Component: Alaska Division of Information Technology (3141)

Revenue Type (OMB Fund Code) Revenue Source	Component	Comment	FY2020 Actuals	FY2021 Management Plan	FY2022 Governor
Operating I/A Rec		device config, deployment, maintenance, and replacements)			
6654 Information Services Fund Statutory Operating I/A Rec	Admin - Print Services (2333)	OIT Telecommunications (CISCO device config, deployment, maintenance, and replacements)	1.1	1.1	1.1
6654 Information Services Fund Statutory Operating I/A Rec	Admin - Public Defender Agency (1631)	OIT Telecommunications (CISCO device config, deployment, maintenance, and replacements)	64.3	64.3	64.3
6654 Information Services Fund Statutory Operating I/A Rec	Admin - Retirement and Benefits (64)	OIT Telecommunications (CISCO device config, deployment, maintenance, and replacements)	52.4	52.4	52.4
6654 Information Services Fund Statutory Operating I/A Rec	Admin - Risk Management (71)	OIT Telecommunications (CISCO device config, deployment, maintenance, and replacements)	3.9	3.9	3.9
6654 Information Services Fund Statutory Operating I/A Rec	Admin - Stwd Contracting and Property (3262)	OIT Telecommunications (CISCO device config, deployment, maintenance, and replacements)	8.5	8.5	8.5
6654 Information Services Fund Statutory Operating I/A Rec	Admin - Violent Crimes Comp Board (2694)	OIT Telecommunications (CISCO device config, deployment, maintenance, and replacements)	1.3	1.3	1.3
6654 Information Services Fund Statutory Operating I/A Rec	Commerce - Department-wide	OIT Telecommunications (CISCO device config, deployment, maintenance, and replacements)	202.3	203.3	203.3
6654 Information Services Fund Statutory Operating I/A Rec	Correct - Department-wide	OIT Telecommunications (CISCO device config, deployment, maintenance, and replacements)	302.6	307.7	307.7
6654 Information Services Fund Statutory Operating I/A Rec	E&ED - Department-wide	OIT Telecommunications (CISCO device config, deployment, maintenance, and replacements)	116.9	114.1	114.1
6654 Information Services Fund Statutory Operating I/A Rec	EnvCon - Department-wide	OIT Telecommunications (CISCO device config, deployment, maintenance, and replacements)	228.3	230.7	230.7
6654 Information Services Fund Statutory Operating I/A Rec	FishGm - Department-wide	OIT Telecommunications (CISCO device config, deployment, maintenance, and replacements)	208.3	210.0	210.0
6654 Information Services Fund Statutory Operating I/A Rec	Gov - Department-wide	OIT Telecommunications (CISCO device config, deployment,	104.5	104.5	104.5

Revenue Detail (1681)
Department of Administration

Component: Alaska Division of Information Technology (3141)

Revenue Type (OMB Fund Code) Revenue Source	Component	Comment	FY2020 Actuals	FY2021 Management Plan	FY2022 Governor
6654 Information Services Fund Statutory Operating I/A Rec	H&SS - Department-wide	maintenance, and replacements) OIT Telecommunications (CISCO device config, deployment, maintenance, and replacements)	1,202.7	1,262.8	1,262.8
6654 Information Services Fund Statutory Operating I/A Rec	Labor - Department-wide	OIT Telecommunications (CISCO device config, deployment, maintenance, and replacements)	328.3	336.6	336.6
6654 Information Services Fund Statutory Operating I/A Rec	Law - Department-wide	OIT Telecommunications (CISCO device config, deployment, maintenance, and replacements)	209.1	215.2	230.0
6654 Information Services Fund Statutory Operating I/A Rec	Legis - Department-wide	OIT Telecommunications (CISCO device config, deployment, maintenance, and replacements)	285.1	300.0	310.0
6654 Information Services Fund Statutory Operating I/A Rec	M&VA - Department-wide	OIT Telecommunications (CISCO device config, deployment, maintenance, and replacements)	7.4	40.7	40.7
6654 Information Services Fund Statutory Operating I/A Rec	NatRes - Department-wide	OIT Telecommunications (CISCO device config, deployment, maintenance, and replacements)	314.5	316.3	316.3
6654 Information Services Fund Statutory Operating I/A Rec	PubSaf - Department-wide	OIT Telecommunications (CISCO device config, deployment, maintenance, and replacements)	228.0	235.2	235.2
6654 Information Services Fund Statutory Operating I/A Rec	Rev - Department-wide	OIT Telecommunications (CISCO device config, deployment, maintenance, and replacements)	221.0	223.7	223.7
6654 Information Services Fund Statutory Operating I/A Rec	Trans - Department-wide	OIT Telecommunications (CISCO device config, deployment, maintenance, and replacements)	621.8	644.4	644.4
6654 Information Services Fund Statutory Operating I/A Rec	Admin - Accounting (3134)	OIT Server Hosting and Storage	2.9	2.9	2.9
6654 Information Services Fund Statutory Operating I/A Rec	Admin - Administrative Hearings (2771)	OIT Server Hosting and Storage	3.2	3.2	3.2
6654 Information Services Fund Statutory Operating I/A Rec	Admin - Alaska Public Offices Comm (70)	OIT Server Hosting and Storage	3.3	3.3	3.3
6654 Information Services Fund Statutory Operating I/A Rec	Admin - Facilities Administration (2430)	OIT Server Hosting and Storage	2.8	2.8	2.8
6654 Information Services Fund Statutory	Admin - Finance (59)	OIT Server Hosting and Storage	269.0	269.0	269.0

Revenue Detail (1681)
Department of Administration

Component: Alaska Division of Information Technology (3141)

Revenue Type (OMB Fund Code) Revenue Source	Component	Comment	FY2020 Actuals	FY2021 Management Plan	FY2022 Governor
Operating I/A Rec 6654 Information Services Fund Statutory	Admin - Lease Administration (2304)	OIT Server Hosting and Storage	2.9	2.9	2.9
Operating I/A Rec 6654 Information Services Fund Statutory	Admin - Motor Vehicles (2348)	OIT Server Hosting and Storage	340.4	340.4	340.4
Operating I/A Rec 6654 Information Services Fund Statutory	Admin - Office of Public Advocacy (43)	OIT Server Hosting and Storage	54.0	54.0	54.0
Operating I/A Rec 6654 Information Services Fund Statutory	Admin - Personnel (56)	OIT Server Hosting and Storage	2.9	2.9	2.9
Operating I/A Rec 6654 Information Services Fund Statutory	Admin - Print Services (2333)	OIT Server Hosting and Storage	2.8	2.8	2.8
Operating I/A Rec 6654 Information Services Fund Statutory	Admin - Public Defender Agency (1631)	OIT Server Hosting and Storage	73.8	73.8	73.8
Operating I/A Rec 6654 Information Services Fund Statutory	Admin - Retirement and Benefits (64)	OIT Server Hosting and Storage	214.0	214.0	214.0
Operating I/A Rec 6654 Information Services Fund Statutory	Admin - Violent Crimes Comp Board (2694)	Online application and maintenance support	6.0	6.0	6.0
Operating I/A Rec 6654 Information Services Fund Statutory	Commerce - Department-wide	OIT Server Hosting and Storage	128.7	102.1	50.0
Operating I/A Rec 6654 Information Services Fund Statutory	Correct - Department-wide	OIT Server Hosting and Storage	373.5	327.6	327.6
Operating I/A Rec 6654 Information Services Fund Statutory	E&ED - Department-wide	OIT Server Hosting and Storage	141.6	176.4	176.4
Operating I/A Rec 6654 Information Services Fund Statutory	EnvCon - Department-wide	OIT Server Hosting and Storage	305.9	335.0	335.0
Operating I/A Rec 6654 Information Services Fund Statutory	FishGm - Department-wide	OIT Server Hosting and Storage	731.7	731.7	731.7
Operating I/A Rec 6654 Information Services Fund Statutory	Gov - Department-wide	OIT Server Hosting and Storage	18.7	19.1	19.1
Operating I/A Rec 6654 Information Services Fund Statutory	H&SS - Department-wide	OIT Server Hosting and Storage	442.3	442.3	442.3
Operating I/A Rec 6654 Information Services Fund Statutory	Labor - Department-wide	OIT Server Hosting and Storage	57.6	57.6	57.6
Operating I/A Rec 6654 Information Services Fund Statutory	Law - Department-wide	OIT Server Hosting and Storage	473.8	473.8	473.8
Operating I/A Rec 6654 Information Services Fund Statutory	Legis - Department-wide	OIT Server Hosting and Storage	14.4	14.4	14.4

Revenue Detail (1681)
Department of Administration

Component: Alaska Division of Information Technology (3141)

Revenue Type (OMB Fund Code)	Component	Comment	FY2020 Actuals	FY2021 Management Plan	FY2022 Governor
6654 Information Services Fund Statutory Operating I/A Rec	M&VA - Department-wide	OIT Licensing (SQL Rates)	15.2	162.4	170.0
6654 Information Services Fund Statutory Operating I/A Rec	NatRes - Department-wide	OIT Server Hosting and Storage	280.2	373.7	373.7
6654 Information Services Fund Statutory Operating I/A Rec	PubSaf - Department-wide	OIT Server Hosting and Storage	455.2	455.2	455.2
6654 Information Services Fund Statutory Operating I/A Rec	Rev - Department-wide	OIT Server Hosting and Storage	398.7	383.7	383.7
6654 Information Services Fund Statutory Operating I/A Rec	Trans - Department-wide	OIT Server Hosting and Storage	57.6	100.7	100.7
6654 Information Services Fund Statutory Operating I/A Rec	Admin - Finance (59)	OIT MICS (Mainframe Usage)	28.6	28.6	28.6
6654 Information Services Fund Statutory Operating I/A Rec	Admin - Lease Administration (2304)	IT Technical Support for SSoA	0.8	0.8	0.8
6654 Information Services Fund Statutory Operating I/A Rec	Admin - Motor Vehicles (2348)	OIT MICS (Mainframe Usage)	20.2	20.2	20.2
6654 Information Services Fund Statutory Operating I/A Rec	Admin - Office of Public Advocacy (43)	OIT Licensing (SQL Rates)	4.3	4.3	4.3
6654 Information Services Fund Statutory Operating I/A Rec	Admin - Personnel (56)	OIT MICS (Mainframe Usage)	0.1	0.1	0.1
6654 Information Services Fund Statutory Operating I/A Rec	Admin - Retirement and Benefits (64)	OIT MICS (Mainframe Usage)	2.0	2.0	2.0
6654 Information Services Fund Statutory Operating I/A Rec	Commerce - Department-wide	OIT Licensing (SQL Rates)	103.4	103.4	103.4
6654 Information Services Fund Statutory Operating I/A Rec	Correct - Department-wide	OIT MICS (Mainframe Usage)	2.2	3.3	3.3
6654 Information Services Fund Statutory Operating I/A Rec	E&ED - Department-wide	OIT MICS (Mainframe Usage)	8.2	8.5	8.5
6654 Information Services Fund Statutory Operating I/A Rec	EnvCon - Department-wide	OIT Licensing (SQL Rates)	64.6	64.6	64.6
6654 Information Services Fund Statutory Operating I/A Rec	FishGm - Department-wide	OIT Licensing (SQL Rates)	182.5	182.5	182.5
6654 Information Services Fund Statutory Operating I/A Rec	Gov - Department-wide	OIT MICS (Mainframe Usage)	0.4	0.4	0.4
6654 Information Services Fund Statutory Operating I/A Rec	H&SS - Department-wide	OIT MICS (Mainframe Usage)	1,274.5	1,612.4	1,612.4
6654 Information Services Fund Statutory	Labor - Department-wide	OIT MICS (Mainframe Usage)	23.9	23.9	23.9

Revenue Detail (1681)
Department of Administration

Component: Alaska Division of Information Technology (3141)

Revenue Type (OMB Fund Code) Revenue Source	Component	Comment	FY2020 Actuals	FY2021 Management Plan	FY2022 Governor
Operating I/A Rec 6654 Information Services Fund Statutory	Law - Department-wide	OIT MICS (Mainframe Usage)	3.0	3.6	3.6
Operating I/A Rec 6654 Information Services Fund Statutory	Legis - Department-wide	OIT MICS (Mainframe Usage)	0.7	0.7	0.7
Operating I/A Rec 6654 Information Services Fund Statutory	NatRes - Department-wide	OIT MICS (Mainframe Usage)	103.6	182.1	182.1
Operating I/A Rec 6654 Information Services Fund Statutory	PubSaf - Department-wide	OIT MICS (Mainframe Usage)	636.0	1,002.1	1,002.0
Operating I/A Rec 6654 Information Services Fund Statutory	Rev - Department-wide	OIT MICS (Mainframe Usage)	1,586.4	1,586.4	969.2
Operating I/A Rec 6654 Information Services Fund Statutory	Trans - Department-wide	OIT MICS (Mainframe Usage)	6.9	14.2	14.2
Operating I/A Rec 6654 Information Services Fund Statutory	Admin - Finance (59)	OIT Oracle costs	259.8	259.8	259.8
Operating I/A Rec 6654 Information Services Fund Statutory	Admin - Motor Vehicles (2348)	OIT Licensing (SQL Rates)	17.1	17.1	17.1
Operating I/A Rec 6654 Information Services Fund Statutory	Admin - Retirement and Benefits (64)	OIT Oracle costs	484.9	484.9	484.9
Operating I/A Rec 6654 Information Services Fund Statutory	Correct - Department-wide	OIT Licensing (SQL Rates)	104.2	106.9	106.9
Operating I/A Rec 6654 Information Services Fund Statutory	FishGm - Department-wide	OIT Oracle costs	282.2	282.2	282.2
Operating I/A Rec 6654 Information Services Fund Statutory	Law - Department-wide	OIT Licensing (SQL Rates)	34.2	35.1	35.1
Operating I/A Rec 6654 Information Services Fund Statutory	NatRes - Department-wide	OIT Licensing (SQL Rates)	30.4	31.2	31.2
Operating I/A Rec 6654 Information Services Fund Statutory	PubSaf - Department-wide	OIT Licensing (SQL Rates)	119.6	122.7	122.7
Operating I/A Rec 6654 Information Services Fund Statutory	Rev - Department-wide	OIT Licensing (SQL Rates)	174.9	179.3	179.3
Operating I/A Rec 6654 Information Services Fund Statutory	Trans - Department-wide	AMHS 100 MEG Circuit Order Change	5.2	5.2	5.2
Operating I/A Rec 6654 Information Services Fund Statutory	NatRes - Department-wide	OIT Line of Business costs	1,287.4	1,700.0	1,405.4
6658 Information Services Fund - Prior Year Reimburse Recovery			0.2	0.2	0.2

Revenue Detail (1681)
Department of Administration

Component: Alaska Division of Information Technology (3141)

Inter-Agency Services (1682)
Department of Administration

Component: Alaska Division of Information Technology (3141)

				FY2020 Actuals	FY2021 Management Plan	FY2022 Governor
Component Totals				6,056.1	3,545.2	2,617.8
With Department of Transportation/Public Facilities				46.0	46.2	46.2
With Department of Administration				6,006.0	3,494.0	2,566.1
With Department of Revenue				4.1	5.0	5.5
Object Class	Servicing Agency	Explanation	FY2020 Actuals	FY2021 Management Plan	FY2022 Governor	
3020	Inter-Agency Building Maintenance	Trans - Department-wide	Building maintenance services	24.8	25.0	25.0
3021	Inter-Agency Mail	Admin - Print Services (2333)	Centralized mail services chargeback	4.1	5.0	5.0
3022	Inter-Agency Human Resources	Admin - Administrative Services (46)	HR Consultant	97.2	100.0	100.0
3022	Inter-Agency Human Resources	Admin - Personnel (56)	Human resource and payroll services provided by the Division of Personnel	156.1	200.0	156.1
3022	Inter-Agency Human Resources	Admin - Personnel (56)	Classification Position	56.3	90.0	0.0
3023	Inter-Agency Building Leases	Admin - Facilities (2429)	Rent for state-owned facilities and lease payments	666.0	776.0	700.0
3023	Inter-Agency Building Leases	Admin - Facilities Administration (2430)	Rent for state-owned facilities and lease payments	29.0	29.0	29.0
3023	Inter-Agency Building Leases	Admin - Leases (81)	Rent for state-owned facilities and lease payments	253.0	320.0	320.0
3026	Inter-Agency Insurance	Admin - Risk Management (71)	Division of Risk Management - Risk management insurance charges	20.3	20.3	20.3
3027	Inter-Agency Financial	Admin - Accounting (3134)	SSoA Accounts Payable, Travel, and AAPEX Chargeback	50.3	50.3	50.3
3027	Inter-Agency Financial	Admin - Finance (59)	Division of Finance Chargeback for IRIS FIN, HRM, and ALDER	13.8	13.8	13.8
3028	Inter-Agency Americans with Disabilities Act Compliance	Admin - Personnel (56)	Americans with Disabilities Act (ADA) Chargeback	1.9	1.9	1.9
3037	State Equipment Fleet	Trans - Department-wide	State equipment fleet chargeback for vehicle lease, maintenance, and fuel	21.2	21.2	21.2

Inter-Agency Services (1682)
Department of Administration

Component: Alaska Division of Information Technology (3141)

Object Class	Servicing Agency	Explanation	FY2020 Actuals	FY2021 Management Plan	FY2022 Governor
3038 Inter-Agency Management/Consulting	Admin - Administrative Services (46)	Support services provided by the Division of Administrative Services	442.9	443.1	442.9
3038 Inter-Agency Management/Consulting	Admin - Facilities (2429)	Electrical consumption costs	122.6	122.6	122.6
3038 Inter-Agency Management/Consulting	Admin - Motor Vehicles (2348)	State Employee ID costs	0.1	0.5	0.5
3038 Inter-Agency Management/Consulting	Admin - Office of the Commissioner (45)	Support services provided by the Office of the Commissioner	349.0	200.0	200.0
3038 Inter-Agency Management/Consulting	Admin - Stwd Contracting and Property (3262)	SSoA Procurement Chargeback	403.7	403.7	403.7
3038 Inter-Agency Management/Consulting	Rev - Department-wide	Trustwave services	4.1	5.0	5.5
3038 Inter-Agency Management/Consulting	Admin - Administrative Services (46)	OIT Accounting services	342.8	0.0	0.0
3038 Inter-Agency Management/Consulting	Admin - Office of the Commissioner (45)	AAPEX Restructure Contract	2,996.9	717.8	0.0

Personal Services Expenditure Detail
Department of Administration

Scenario: FY2022 Governor (17280)
Component: Alaska Division of Information Technology (3141)
RDU: Office of Information Technology (653)

PCN	Job Class Title	Time Status	Retire Code	Barg Unit	Location	Salary Sched	Range / Step	Comp Months	Split / Count	Annual Salaries	COLA	Premium Pay	Annual Benefits	Total Costs	UGF Amount
02-0013	Systems Programmer I	FT	A	GP	Juneau	205	20G	12.0		87,575	1,214	2,780	49,872	141,441	0
02-1035	Internet Specialist II	FT	A	GP	Juneau	205	19F / G	12.0		80,599	1,083	0	46,516	128,198	0
02-1048	Administrative Officer II	FT	A	GP	Anchorage	200	19K	12.0		83,889	1,127	0	47,648	132,664	0
02-1105	Micro/Net Sp II	FT	A	SS	Anchorage	200	20B / C	12.0		77,029	0	2,500	46,188	125,717	0
02-1155	Micro/Net Sp I	FT	A	GP	Juneau	205	18M	12.0		87,906	1,261	5,932	51,071	146,170	0
02-1534	Micro/Net Sp I	FT	A	GP	Anchorage	200	18J / K	12.0		78,011	1,048	0	45,626	124,685	0
02-2095	Micro/Net Sp II	FT	A	SS	Juneau	99	20N	12.0		107,509	0	13,632	60,503	181,644	0
02-3001	Dep Chf Inf Ofc	FT	A	XE	Anchorage	N00	27U / V	12.0		183,730	0	0	79,380	263,110	0
02-3005	Administrative Assistant III	FT	A	SS	Juneau	605	15F / J	12.0		64,785	0	3,003	42,149	109,937	0
02-3006	Administrative Officer I	FT	A	SS	Juneau	205	17D / E	12.0		70,853	0	0	43,204	114,057	0
02-3019	Data Processing Manager I	FT	A	SS	Anchorage	99	22P	12.0		125,892	0	432	62,286	188,610	0
02-3054	Accountant IV	FT	A	SS	Juneau	205	20C / D	12.0		83,921	0	0	47,699	131,620	0
02-3080	DPT Tech Ofciii	FT	A	SS	Juneau	205	25D / E	12.0		119,884	0	432	60,219	180,535	0
02-3086	Administrative Assistant II	FT	A	GP	Juneau	205	14A / B	12.0		48,358	679	2,171	36,172	87,380	0
02-3108	Systems Programmer III	FT	A	SS	Anchorage	99	23N	12.0		125,313	0	5,432	63,807	194,552	0
02-3109	Data Comm Sp II	FT	A	GP	Anchorage	200	21K / L	12.0		98,267	1,335	1,100	52,973	153,675	0
02-3111	Micro/Net Sp II	FT	A	GP	Fairbanks	99	20O	12.0		105,018	1,425	1,000	55,261	162,704	0
02-3112	Data Comm Sp I	FT	A	GP	Anchorage	200	19F / G	12.0		78,020	1,065	1,200	46,042	126,327	0
02-3113	Systems Programmer II	FT	A	GP	Juneau	205	22L / M	12.0		113,826	1,530	0	57,946	173,302	0
02-3114	Systems Programmer II	FT	A	GP	Juneau	205	22L / M	12.0		111,711	1,550	3,632	58,468	175,361	0
02-3115	Accounting Technician II	FT	A	GP	Juneau	205	14B	12.0		48,965	677	1,393	36,113	87,148	0
02-3117	Systems Programmer II	FT	A	GP	Anchorage	200	22D / E	12.0		88,697	1,203	800	49,577	140,277	0
02-3120	Data Processing Manager II	FT	A	SS	Anchorage	200	23K	12.0		112,757	0	2,932	58,627	174,316	0
02-5148	Systems Programmer I	FT	A	GG	Juneau	205	20L / M	12.0		99,660	1,392	3,932	54,426	159,410	0
02-5174	Chief Technology Officer III	FT	A	XE	Anchorage	N00	26A / B	12.0		101,598	0	0	53,636	155,234	0
02-6300	Deputy Director	FT	A	XE	Anchorage	N00	25S	12.0		157,541	0	0	71,977	229,518	0
02-6301	Chief Technology Officer I	FT	A	XE	Anchorage	N00	24J	12.0		109,902	0	0	56,493	166,395	0
02-6304	Systems Programmer II	FT	A	GP	Anchorage	200	22G / J	12.0		98,836	1,381	3,932	54,143	158,292	0
02-6307	Accountant V	FT	A	SS	Juneau	205	22C / D	12.0		96,039	0	0	51,868	147,907	0
02-6308	Office Assistant II	FT	A	GP	Juneau	205	10C / D	12.0		39,567	552	1,512	32,922	74,553	0
02-6312	Systems Programmer II	FT	A	GP	Anchorage	200	22F / G	12.0		95,180	1,320	3,000	52,564	152,064	0
02-6314	Database Specialist III	FT	A	GP	Juneau	205	22C / D	12.0		88,507	1,366	13,132	53,754	156,759	0
02-6316	Accountant II	FT	A	GP	Juneau	205	16C / D	12.0		59,126	795	0	39,130	99,051	0
02-6400	Chief Technology Officer II	FT	A	XE	Juneau	N05	25R / S	12.0		164,318	0	432	74,015	238,765	0
02-6401	Data Processing Manager III	FT	A	SS	Anchorage	99	24N	12.0		133,860	0	432	65,027	199,319	0
02-6402	Administrative Assistant III	FT	A	GP	Anchorage	200	15C / D	12.0		53,381	744	1,991	37,838	93,954	0
02-6404	Database Specialist II	FT	A	GP	Juneau	205	21A / B	12.0		78,320	1,120	5,000	47,452	131,892	0
02-6408	Systems Programmer III	FT	A	SS	Anchorage	200	23K	12.0		112,757	0	7,432	60,175	180,364	0

Note: If a position is split, an asterisk (*) will appear in the Split/Count column. If the split position is also counted in the component, two asterisks (**) will appear in this column. [No valid job title] appearing in the Job Class Title indicates that the PCN has an invalid class code or invalid range for the class code effective date of this scenario.

Personal Services Expenditure Detail
Department of Administration

Scenario: FY2022 Governor (17280)
Component: Alaska Division of Information Technology (3141)
RDU: Office of Information Technology (653)

PCN	Job Class Title	Time Status	Retire Code	Barg Unit	Location	Salary Sched	Range / Step	Comp Months	Split / Count	Annual Salaries	COLA	Premium Pay	Annual Benefits	Total Costs	UGF Amount
02-6415	Systems Programmer II	FT	N	GP	Anchorage	200	22J	12.0		99,665	1,144	2,100	31,409	134,318	0
02-6417	Systems Programmer III	FT	A	SS	Juneau	205	23F	12.0		118,622	0	10,032	63,087	191,741	0
02-6418	Systems Programmer II	FT	A	GP	Juneau	99	22P / Q	12.0		128,794	1,805	5,500	64,987	201,086	0
02-6501	Data Processing Manager I	FT	A	SS	Juneau	205	22E / F	12.0		102,433	0	3,000	55,099	160,532	0
02-6502	Systems Programmer II	FT	A	GP	Anchorage	200	22F / G	12.0		95,408	1,312	2,200	52,367	151,287	0
02-6504	Tech Arch Spec	FT	A	SS	Juneau	105	24A / B	12.0		102,284	0	0	54,016	156,300	0
02-6505	Systems Programmer III	FT	A	GP	Anchorage	99	23O	12.0		126,667	1,776	5,500	64,256	198,199	0
02-6506	Systems Programmer III	FT	A	GP	Juneau	99	23N / O	12.0		132,187	1,860	6,232	66,406	206,685	0
02-6507	Data Processing Manager I	FT	A	SS	Anchorage	200	22D / E	12.0		94,028	0	3,200	52,277	149,505	0
02-6508	Data Comm Sp II	FT	A	GP	Juneau	205	21D / E	12.0		86,907	1,193	1,871	49,330	139,301	0
02-6509	Data Comm Sp II	FT	A	GP	Anchorage	200	21C / D	12.0		79,443	1,088	1,500	46,635	128,666	0
02-6510	Data Comm Sp I	FT	A	GP	Fairbanks	203	19F / G	12.0		78,161	1,069	1,400	46,159	126,789	0
02-6511	Systems Programmer III	FT	A	GP	Anchorage	99	23Q	12.0		136,347	1,838	6,932	68,049	213,166	0
02-6513	Systems Programmer III	FT	A	GP	Anchorage	200	23L	12.0		113,958	1,591	4,432	59,516	179,497	0
02-6514	Systems Programmer III	FT	A	GP	Anchorage	99	23N	12.0		122,092	1,715	5,500	62,682	191,989	0
02-6516	Program Coordinator II	FT	A	GP	Anchorage	200	20F / G	12.0		82,345	1,107	0	47,117	130,569	0
02-6518	Data Comm Sp II	FT	A	GP	Anchorage	200	21L	12.0		99,177	1,368	2,585	53,796	156,926	0
02-6522	Data Comm Sp II	FT	A	GP	Juneau	205	21F	12.0		90,773	1,245	1,847	50,652	144,517	0
02-6523	Systems Programmer II	FT	A	GP	Anchorage	200	22A / B	12.0		79,680	1,118	3,500	47,404	131,702	0
02-6524	Data Comm Sp II	FT	A	GP	Anchorage	200	21G / J	12.0		91,631	1,257	1,932	50,976	145,796	0
02-6527	Systems Programmer III	FT	A	GP	Juneau	205	23K / L	12.0		117,770	1,612	2,200	60,060	181,642	0
02-6529	Systems Programmer II	FT	A	GP	Juneau	205	22G / J	12.0		103,259	1,455	5,000	56,031	165,745	0
02-6601	Data Processing Manager III	FT	A	SS	Anchorage	200	24P	12.0		141,357	0	0	67,457	208,814	0
02-6605	Systems Programmer IV	FT	A	SS	Anchorage	200	25L	12.0		133,661	0	5,432	66,678	205,771	0
02-6607	Database Specialist II	FT	A	GP	Juneau	205	21A / B	12.0		78,320	1,183	9,700	49,069	138,272	0
02-6610	Systems Programmer II	FT	A	GP	Juneau	205	22K / L	12.0		111,267	1,541	3,400	58,236	174,444	0
02-6612	Systems Programmer I	FT	A	GP	Juneau	205	20G / J	12.0		90,953	1,372	11,110	53,900	157,335	0
02-6614	DP Prod Mgr	FT	A	SS	Juneau	205	19L / M	12.0		95,500	0	9,932	55,099	160,531	0
02-6616	Micro/Net Tc II	FT	A	GP	Anchorage	200	16D / E	12.0		59,017	820	1,991	39,777	101,605	0
02-6617	Analyst/Programmer V	FT	A	GP	Juneau	205	22J / K	12.0		105,901	1,504	6,032	57,295	170,732	0
02-6621	Database Specialist III	FT	A	SS	Juneau	205	22J / K	12.0		117,463	0	10,032	62,689	190,184	0
02-6624	Data Processing Technician II	FT	A	GP	Anchorage	200	15L / M	12.0		67,881	988	5,663	44,089	118,621	0
02-6639	Data Processing Technician II	FT	A	GP	Juneau	205	15L	12.0		69,498	1,015	6,029	44,772	121,314	0
02-6640	Data Processing Technician II	FT	A	GP	Juneau	205	15F / G	12.0		60,595	879	4,782	41,280	107,536	0
02-6641	Data Processing Technician II	FT	A	GP	Anchorage	200	15G / J	12.0		60,041	824	1,289	39,888	102,042	0

Note: If a position is split, an asterisk (*) will appear in the Split/Count column. If the split position is also counted in the component, two asterisks (**) will appear in this column. [No valid job title] appearing in the Job Class Title indicates that the PCN has an invalid class code or invalid range for the class code effective date of this scenario.

Personal Services Expenditure Detail
Department of Administration

Scenario: FY2022 Governor (17280)
Component: Alaska Division of Information Technology (3141)
RDU: Office of Information Technology (653)

PCN	Job Class Title	Time Status	Retire Code	Barg Unit	Location	Salary Sched	Range / Step	Comp Months	Split / Count	Annual Salaries	COLA	Premium Pay	Annual Benefits	Total Costs	UGF Amount
02-6642	Data Processing Technician II	FT	A	GP	Juneau	205	15F / G	12.0		62,064	1,066	17,242	46,072	126,444	0
02-6645	DP Prod Mgr	FT	A	SS	Anchorage	200	19L	12.0		89,024	0	10,085	52,924	152,033	0
02-6647	Systems Programmer III	FT	A	SS	Juneau	205	23J / K	12.0		116,997	0	3,500	60,281	180,778	0
02-6649	Data Processing Technician II	FT	A	GP	Juneau	205	15G	12.0		62,615	924	6,151	42,446	112,136	0
02-8094	Micro/Net Tc II	FT	A	GP	Juneau	205	16B / C	12.0		56,545	779	1,400	38,723	97,447	0
02-9001	Systems Programmer II	FT	A	GP	Anchorage	200	22E / F	12.0		92,086	1,258	1,500	50,984	145,828	0
02-9014	Systems Programmer II	FT	A	GP	Anchorage	200	22G / J	12.0		96,681	1,299	0	52,049	150,029	0
02-9514	Analyst/Programmer III	FT	A	GP	Anchorage	200	18L / M	12.0		82,288	1,106	0	47,097	130,491	0
02-T183	St Chf Inf Ofc	FT	A	XE	Anchorage	N00	28U / R	12.0		176,122	0	0	77,230	253,352	0
02-X069	Chief Technology Officer III	FT	A	XE	Anchorage	N00	26M	12.0		134,687	0	0	65,019	199,706	0
03-0027	Systems Programmer III	FT	A	SS	Anchorage	200	23L	12.0		116,418	0	6,932	61,263	184,613	0
03-0118	Systems Programmer II	FT	A	GP	Anchorage	200	22E / F	12.0		91,946	1,282	3,432	51,600	148,260	0
03-0200	Micro/Net Tc II	FT	A	GP	Anchorage	200	16K / L	12.0		70,551	948	0	43,060	114,559	0
03-0228	Micro/Net Sp II	FT	A	SS	Juneau	99	20P / Q	12.0		116,608	0	5,932	60,984	183,524	0
03-0254	P3 Manager	FT	A	SS	Anchorage	200	24F	12.0		112,986	0	0	57,697	170,683	0
03-0257	DPT Tech Ofc I	FT	A	SS	Anchorage	200	23K / L	12.0		124,363	0	7,532	64,202	196,097	0
03-0280	Micro/Net Tc II	FT	A	GP	Juneau	205	16C / D	12.0		59,860	805	0	39,382	100,047	0
03-0334	Micro/Net Tc II	FT	A	GP	Anchorage	200	16C / D	12.0		55,612	747	0	37,921	94,280	0
03-6525	Micro/Net Sp I	FT	A	GP	Anchorage	200	18D / E	12.0		66,996	900	0	41,837	109,733	0
04-1024	Systems Programmer I	FT	A	GP	Anchorage	200	20C / D	12.0		74,705	1,004	0	44,489	120,198	0
04-1139	DPT Tech Ofc II	FT	A	SS	Anchorage	200	24J	12.0		116,667	0	0	58,964	175,631	0
04-1149	Micro/Net Sp II	FT	A	GP	Juneau	205	20B	12.0		74,354	999	0	44,368	119,721	0
04-1151	Micro/Net Sp I	FT	A	GP	Juneau	205	18B / C	12.0		64,931	873	0	41,127	106,931	0
04-4035	Micro/Net Sp I	FT	A	GP	Juneau	205	18F / G	12.0		75,426	1,020	432	44,885	121,763	0
04-6064	P3 Manager	FT	A	SS	Anchorage	200	24E / F	12.0		111,452	0	0	57,170	168,622	0
04-7068	Micro/Net Tc II	FT	A	GP	Anchorage	200	16J	12.0		66,534	911	1,279	42,118	110,842	0
04-7110	Micro/Net Tc II	FT	A	GP	Anchorage	200	16C / D	12.0		57,351	785	1,066	38,886	98,088	0
04-7168	Data Processing Manager I	FT	A	SS	Juneau	205	22L / M	12.0		115,308	0	0	58,496	173,804	0
04-7207	Micro/Net Sp I	FT	A	GP	Anchorage	200	18C / D	12.0		64,066	881	1,500	41,345	107,792	0
05-2074	Micro/Net Sp I	FT	A	GP	Anchorage	200	18D / E	12.0		66,814	898	0	41,774	109,486	0
05-7703	Micro/Net Sp II	FT	A	GP	Anchorage	200	20F / G	12.0		83,190	1,118	0	47,408	131,716	0
05-7718	Data Processing Manager I	FT	A	SS	Juneau	205	22D / E	12.0		97,150	0	432	52,399	149,981	0
05-7720	DPT Tech Ofc II	FT	A	SS	Juneau	205	24J	12.0		122,491	0	432	61,116	184,039	0
05-7724	Micro/Net Sp I	FT	A	GP	Juneau	205	18C / D	12.0		68,710	923	0	42,427	112,060	0
06-0360	Micro/Net Tc II	FT	A	GP	Juneau	205	16B / C	12.0		57,603	803	2,169	39,352	99,927	0
06-0617	DPT Tech Ofcii	FT	A	SS	Juneau	205	25U	12.0		187,179	0	0	80,499	267,678	0
06-0657	Data Processing Manager I	FT	A	SS	Juneau	205	22J	12.0		107,016	0	0	55,644	162,660	0

Note: If a position is split, an asterisk (*) will appear in the Split/Count column. If the split position is also counted in the component, two asterisks (**) will appear in this column. [No valid job title] appearing in the Job Class Title indicates that the PCN has an invalid class code or invalid range for the class code effective date of this scenario.

Personal Services Expenditure Detail
Department of Administration

Scenario: FY2022 Governor (17280)
Component: Alaska Division of Information Technology (3141)
RDU: Office of Information Technology (653)

PCN	Job Class Title	Time Status	Retire Code	Barg Unit	Location	Salary Sched	Range / Step	Comp Months	Split / Count	Annual Salaries	COLA	Premium Pay	Annual Benefits	Total Costs	UGF Amount
06-1010	Micro/Net Tc I	FT	A	GP	Anchorage	200	14G	12.0		55,439	774	2,132	38,595	96,940	0
06-1447	Micro/Net Sp II	FT	A	SS	Juneau	205	20F / J	12.0		92,440	0	0	50,630	143,070	0
06-1580	Micro/Net Sp II	FT	A	GP	Anchorage	200	20B / C	12.0		71,627	963	0	43,430	116,020	0
06-1791	Micro/Net Tc II	FT	A	GP	Juneau	205	16B / C	12.0		57,150	786	1,301	38,897	98,134	0
06-1913	Micro/Net Tc II	FT	A	GP	Anchorage	200	16B / C	12.0		54,426	748	1,239	37,939	94,352	0
06-1944	Systems Programmer II	FT	A	SS	Anchorage	200	22J / K	12.0		102,333	0	0	54,033	156,366	0
06-2283	Database Specialist III	FT	A	GP	Juneau	205	22K	12.0		108,050	1,600	11,000	59,744	180,394	0
06-3974	Database Specialist II	FT	A	GP	Juneau	205	21G	12.0		93,756	1,335	5,600	52,969	153,660	0
06-4066	Systems Programmer I	FT	A	GP	Anchorage	200	20G	12.0		83,402	1,171	3,732	48,764	137,069	0
06-4500	Micro/Net Sp I	FT	A	GP	Anchorage	200	18G / J	12.0		75,174	1,016	432	44,799	121,421	0
06-4863	Micro/Net Tc II	FT	A	GP	Juneau	205	16B / C	12.0		57,754	805	2,169	39,404	100,132	0
06-8096	Micro/Net Sp I	FT	A	GP	Juneau	205	18C / D	12.0		68,710	923	0	42,427	112,060	0
06-8532	Systems Programmer II	FT	A	GP	Anchorage	200	22J	12.0		99,665	1,386	3,432	54,256	158,739	0
06-8596	Micro/Net Tc II	FT	A	GP	Anchorage	200	16G / J	12.0		65,540	901	1,474	41,843	109,758	0
07-1227	Micro/Net Tc II	FT	A	GP	Juneau	99	16P	12.0		85,870	1,154	0	48,330	135,354	0
07-1732	Micro/Net Sp I	FT	A	GP	Anchorage	200	18L / M	12.0		81,629	1,097	0	46,871	129,597	0
07-3045	Systems Programmer II	FT	A	SS	Juneau	205	22F / J	12.0		104,049	0	0	54,623	158,672	0
07-4543	Micro/Net Sp I	FT	A	GP	Juneau	205	18C / D	12.0		67,176	903	0	41,899	109,978	0
07-5016	Data Processing Technician II	FT	A	GP	Juneau	205	15J	12.0		65,189	998	9,072	44,336	119,595	0
07-5023	Systems Programmer II	FT	A	GP	Juneau	205	22J / K	12.0		108,050	1,494	3,132	57,037	169,713	0
07-5080	Chief Technology Officer II	FT	A	XE	Juneau	N05	25K / L	12.0		131,380	0	0	63,881	195,261	0
07-5336	DPT Tech Ofc II	FT	A	SS	Juneau	99	24P	12.0		151,298	0	0	70,356	221,654	0
07-5400	P3 Manager	FT	A	SS	Juneau	99	24P	12.0		151,278	0	0	70,350	221,628	0
07-5490	Data Processing Technician II	FT	A	GP	Juneau	99	15T	12.0		92,837	1,432	13,702	55,440	163,411	0
07-5758	Systems Programmer II	FT	A	GP	Anchorage	200	22J / K	12.0		102,092	1,378	432	54,059	157,961	0
08-0415	Systems Programmer II	FT	A	GP	Juneau	205	22F / G	12.0		97,418	1,355	3,432	53,483	155,688	0
08-0424	Micro/Net Sp II	FT	A	GP	Anchorage	200	20C / D	12.0		74,594	1,023	1,530	44,977	122,124	0
08-1116	Systems Programmer II	FT	A	GP	Anchorage	200	22A / B	12.0		78,494	1,055	0	45,792	125,341	0
08-1119	Micro/Net Sp II	FT	A	GP	Juneau	205	20B / C	12.0		76,011	1,027	432	45,087	122,557	0
08-1122	DPT Tech Ofc II	FT	A	SS	Juneau	205	24C / D	12.0		109,387	0	0	56,459	165,846	0
08-2072	Systems Programmer III	FT	A	SS	Anchorage	200	23F	12.0		105,768	0	5,000	56,934	167,702	0
08-3096	Micro/Net Sp I	FT	A	GP	Anchorage	200	18K	12.0		78,527	1,061	432	45,952	125,972	0
09-0221	Micro/Net Sp I	FT	A	GP	Joint Base Elmendorf - Richardson	200	18C / D	12.0		64,892	872	0	41,113	106,877	0
09-0227	Micro/Net Tc II	FT	A	GP	Joint Base Elmendorf -	200	16L	12.0		70,922	953	0	43,187	115,062	0

Note: If a position is split, an asterisk (*) will appear in the Split/Count column. If the split position is also counted in the component, two asterisks (**) will appear in this column. [No valid job title] appearing in the Job Class Title indicates that the PCN has an invalid class code or invalid range for the class code effective date of this scenario.

Personal Services Expenditure Detail
Department of Administration

Scenario: FY2022 Governor (17280)
Component: Alaska Division of Information Technology (3141)
RDU: Office of Information Technology (653)

PCN	Job Class Title	Time Status	Retire Code	Barg Unit	Location	Salary Sched	Range / Step	Comp Months	Split / Count	Annual Salaries	COLA	Premium Pay	Annual Benefits	Total Costs	UGF Amount
09-0303	Micro/Net Sp II	FT	A	GP	Richardson Joint Base Elmendorf - Richardson	200	20C / D	12.0		73,821	992	0	44,185	118,998	0
09-0331	Systems Programmer II	FT	A	GP	Richardson Joint Base Elmendorf - Richardson	200	22C / D	12.0		85,176	1,145	0	48,091	134,412	0
09-0334	Micro/Net Tc II	FT	A	GP	Richardson Joint Base Elmendorf - Richardson	99	16O / P	12.0		79,372	1,067	0	46,094	126,533	0
09-0380	Micro/Net Tc II	FT	A	GP	Richardson Joint Base Elmendorf - Richardson	200	16A / B	12.0		52,899	711	0	36,988	90,598	0
09-0409	Internet Specialist II	FT	A	GP	Richardson Joint Base Elmendorf - Richardson	200	19D / E	12.0		70,991	954	0	43,211	115,156	0
09-0415	DPT Tech Ofc I	FT	A	SS	Richardson Joint Base Elmendorf - Richardson	200	23F / J	12.0		107,913	0	0	55,952	163,865	0
10-0283	Micro/Net Sp I	FT	A	GP	Anchorage	99	18N	12.0		86,831	1,173	432	48,809	137,245	0
10-0284	Micro/Net Tc II	FT	A	GP	Anchorage	200	16B / C	12.0		54,715	735	0	37,612	93,062	0
10-0289	Analyst/Programmer IV	FT	A	GP	Anchorage	200	20J / K	12.0		87,383	1,174	0	48,850	137,407	0
10-0295	Analyst/Programmer IV	FT	A	GP	Anchorage	200	20D / E	12.0		77,053	1,036	0	45,297	123,386	0
10-0335	Admn OPS Mgr II	FT	A	SS	Juneau	205	23F	12.0		111,051	0	0	57,032	168,083	0
10-0346	Analyst/Programmer IV	FT	A	GP	Anchorage	200	20K	12.0		89,739	1,206	0	49,661	140,606	0
10-0347	Analyst/Programmer IV	FT	A	GP	Anchorage	200	20D / E	12.0		77,053	1,036	0	45,297	123,386	0
10-0348	Analyst/Programmer V	FT	A	SS	Anchorage	200	22F / J	12.0		100,980	0	0	53,567	154,547	0
10-0349	Analyst/Programmer IV	FT	A	GP	Anchorage	200	20D / E	12.0		77,246	1,038	0	45,363	123,647	0
10-0352	Data Processing Manager I	FT	A	SS	Anchorage	200	22F	12.0		98,696	0	0	52,782	151,478	0
10-0377	DPT Tech Ofc II	FT	A	SS	Anchorage	200	24K / L	12.0		123,223	0	432	61,368	185,023	0
10-0379	Analyst/Programmer III	FT	A	GP	Anchorage	200	18G / J	12.0		75,424	1,014	0	44,736	121,174	0
10-0381	Database Specialist III	FT	A	GP	Anchorage	200	22G / J	12.0		96,184	1,333	3,000	52,910	153,427	0
10-0386	Systems Programmer II	FT	A	GP	Juneau	205	22E / F	12.0		95,815	1,319	2,300	52,542	151,976	0
10-0391	Analyst/Programmer IV	FT	A	GP	Anchorage	200	20C / D	12.0		75,257	1,011	0	44,679	120,947	0
10-0392	Analyst/Programmer V	FT	A	GP	Anchorage	200	22J	12.0		99,665	1,339	0	53,075	154,079	0
10-0403	Analyst/Programmer IV	FT	A	GP	Anchorage	99	20R	12.0		115,015	1,546	0	58,355	174,916	0
10-0407	Micro/Net Sp II	FT	A	SS	Anchorage	200	20D / E	12.0		82,299	0	0	47,141	129,440	0
10-0423	Micro/Net Sp I	FT	A	GP	Fairbanks	203	18E / F	12.0		72,277	1,001	2,200	44,410	119,888	0
10-0432	Micro/Net Tc II	FT	A	GP	Anchorage	200	16C / D	12.0		56,569	760	0	38,250	95,579	0

Note: If a position is split, an asterisk (*) will appear in the Split/Count column. If the split position is also counted in the component, two asterisks (**) will appear in this column.
[No valid job title] appearing in the Job Class Title indicates that the PCN has an invalid class code or invalid range for the class code effective date of this scenario.

Personal Services Expenditure Detail
Department of Administration

Scenario: FY2022 Governor (17280)
Component: Alaska Division of Information Technology (3141)
RDU: Office of Information Technology (653)

PCN	Job Class Title	Time Status	Retire Code	Barg Unit	Location	Salary Sched	Range / Step	Comp Months	Split / Count	Annual Salaries	COLA	Premium Pay	Annual Benefits	Total Costs	UGF Amount
10-3105	Analyst/Programmer II	FT	A	GP	Anchorage	200	16B / C	12.0		54,282	730	0	37,463	92,475	0
11-0225	Systems Programmer I	FT	A	GP	Juneau	205	20F / G	12.0		87,129	1,177	432	48,911	137,649	0
11-0248	DPT Tech Ofc II	FT	A	SS	Juneau	205	24J	12.0		122,491	0	0	60,967	183,458	0
11-1130	Micro/Net Sp II	FT	A	GP	Fairbanks	203	20L	12.0		95,453	1,295	932	51,947	149,627	0
11-1283	Micro/Net Sp I	FT	A	GP	Kodiak	211	18M	12.0		92,918	1,249	0	50,754	144,921	0
11-1340	Systems Programmer III	FT	A	SS	Juneau	99	23Q	12.0		146,939	0	0	69,124	216,063	0
11-1362	Micro/Net Tc II	FT	A	GP	Anchorage	200	16F / G	12.0		61,934	838	432	40,244	103,448	0
11-1401	Micro/Net Tc II	FT	A	GP	Juneau	205	16C / D	12.0		59,677	814	895	39,627	101,013	0
11-1678	Micro/Net Sp I	FT	A	GP	Juneau	205	18E / F	12.0		72,795	978	0	43,832	117,605	0
11-1972	Systems Programmer II	FT	A	GP	Juneau	205	22G	12.0		100,464	1,356	432	53,499	155,751	0
11-2079	Micro/Net Tc II	FT	A	GP	Anchorage	200	16D / E	12.0		58,754	796	442	39,154	99,146	0
11-4268	Micro/Net Sp I	FT	A	SS	Anchorage	200	18J	12.0		78,125	0	432	45,854	124,411	0
11-5013	Micro/Net Tc I	FT	A	GP	Juneau	205	14D / E	12.0		53,578	726	403	37,360	92,067	0
11-5325	Data Processing Manager I	FT	A	SS	Juneau	205	22A / B	12.0		89,369	0	0	49,573	138,942	0
12-1382	Micro/Net Tc II	FT	A	GP	Anchorage	100	16D / E	12.0		58,371	802	1,326	39,326	99,825	0
12-1671	Micro/Net Sp I	FT	A	GP	Anchorage	100	18J	12.0		76,752	1,058	1,932	45,858	125,600	0
12-1717	Micro/Net Sp II	FT	A	GP	Anchorage	100	20K / L	12.0		92,521	1,249	432	50,766	144,968	0
12-1778	Micro/Net Tc II	FT	A	GP	Anchorage	100	16C / D	12.0		56,126	754	0	38,098	94,978	0
12-1848	Micro/Net Tc II	FT	A	GP	Anchorage	99	16O / P	12.0		80,725	1,103	1,350	47,024	130,202	0
12-2016	DPT Tech Ofciii	FT	A	SS	Anchorage	100	25E / F	12.0		120,359	0	0	60,234	180,593	0
12-3804	Data Processing Manager I	FT	A	SS	Anchorage	100	22L	12.0		108,638	0	0	56,202	164,840	0
12-4412	Data Comm Sp II	FT	A	GP	Anchorage	99	21Q / R	12.0		123,475	1,672	932	61,586	187,665	0
12-4616	Micro/Net Sp I	FT	A	GP	Anchorage	100	18D / E	12.0		67,961	913	0	42,169	111,043	0
12-4627	Micro/Net Sp I	FT	A	GP	Anchorage	100	18B / C	12.0		63,609	866	800	40,947	106,222	0
12-4701	Analyst/Programmer IV	FT	A	GP	Anchorage	200	20A / B	12.0		69,748	937	0	42,784	113,469	0
12-4900	Data Processing Manager I	FT	A	SS	Anchorage	100	22F	12.0		98,696	0	1,500	53,298	153,494	0
12-5108	Micro/Net Sp I	FT	A	GP	Anchorage	200	18C / D	12.0		64,800	892	1,532	41,609	108,833	0
12-5232	Analyst/Programmer II	FT	A	GP	Fairbanks	203	16B / C	12.0		55,469	746	0	37,872	94,087	0
12-5417	Analyst/Programmer V	FT	A	GP	Fort Meyers, FL	200	22M / N	12.0		112,829	1,516	0	57,604	171,949	0
12-5452	Data Processing Manager I	FT	A	SS	Anchorage	200	22F / J	12.0		101,786	0	432	53,993	156,211	0
12-5470	Analyst/Programmer V	FT	A	GP	Anchorage	99	22M / N	12.0		113,049	1,519	0	57,679	172,247	0
18-7043	Systems Programmer II	FT	A	SS	Juneau	205	22F	12.0		103,626	0	0	54,478	158,104	0
18-7430	Micro/Net Sp I	FT	A	GP	Anchorage	200	18G	12.0		73,047	998	1,232	44,342	119,619	0
18-7543	Data Processing Manager I	FT	A	SS	Anchorage	200	22D / E	12.0		95,159	0	0	51,565	146,724	0
18-7552	DPT Tech Ofc I	FT	A	SS	Juneau	205	23L	12.0		122,242	0	0	60,882	183,124	0
18-7596	Micro/Net Tc II	FT	A	GP	Juneau	205	16L	12.0		74,471	1,007	432	44,557	120,467	0
18-7605	Micro/Net Sp II	FT	A	GP	Fairbanks	203	20M	12.0		98,534	1,330	432	52,835	153,131	0
18-7686	Micro/Net Sp II	FT	A	SS	Anchorage	99	20M / N	12.0		99,083	0	432	53,063	152,578	0

Note: If a position is split, an asterisk (*) will appear in the Split/Count column. If the split position is also counted in the component, two asterisks (**) will appear in this column.
 [No valid job title] appearing in the Job Class Title indicates that the PCN has an invalid class code or invalid range for the class code effective date of this scenario.

Personal Services Expenditure Detail
Department of Administration

Scenario: FY2022 Governor (17280)
Component: Alaska Division of Information Technology (3141)
RDU: Office of Information Technology (653)

PCN	Job Class Title	Time Status	Retire Code	Barg Unit	Location	Salary Sched	Range / Step	Comp Months	Split / Count	Annual Salaries	COLA	Premium Pay	Annual Benefits	Total Costs	UGF Amount
20-1010	Micro/Net Tc II	FT	A	GP	Anchorage	200	16C / D	12.0		56,569	760	0	38,250	95,579	0
20-1023	DPT Tech Ofc I	FT	A	SS	Anchorage	200	23D / E	12.0		100,601	0	0	53,437	154,038	0
20-1047	Micro/Net Sp II	FT	A	GP	Juneau	205	20F / G	12.0		87,018	1,170	0	48,725	136,913	0
20-1049	Micro/Net Sp I	FT	A	GP	Juneau	205	18G / J	12.0		79,194	1,064	0	46,033	126,291	0
20-2055	Micro/Net Sp I	FT	A	GP	Anchorage	200	18E / F	12.0		68,798	925	0	42,457	112,180	0
20-6858	Micro/Net Sp II	FT	A	SS	Anchorage	200	20C / D	12.0		78,241	0	1,932	46,410	126,583	0
21-2050	Micro/Net Sp I	FT	A	GP	Anchorage	200	18A / B	12.0		61,597	834	432	40,128	102,991	0
21-3087	Micro/Net Sp I	FT	A	GP	Juneau	205	18B / C	12.0		64,931	899	1,932	41,791	109,553	0
25-0108	Micro/Net Sp II	FT	A	SS	Ketchikan	200	20K	12.0		92,123	0	432	50,669	143,224	0
25-0109	Micro/Net Tc II	FT	A	GP	Anchorage	200	16D / E	12.0		58,754	790	0	39,002	98,546	0
25-0122	Micro/Net Sp II	FT	A	GP	Anchorage	200	20M / N	12.0		97,863	1,321	432	52,604	152,220	0
25-0139	Systems Programmer II	FT	A	GP	Juneau	205	22D / E	12.0		92,513	1,264	1,500	51,131	146,408	0
25-0185	Data Processing Manager I	FT	A	SS	Juneau	205	22D / E	12.0		99,258	0	432	53,124	152,814	0
25-0377	Data Processing Manager I	FT	A	SS	Anchorage	200	22F / J	12.0		100,442	0	432	53,531	154,405	0
25-0383	Micro/Net Sp I	FT	A	GP	Anchorage	99	18O	12.0		90,085	1,211	0	49,780	141,076	0
25-0406	Micro/Net Sp I	FT	A	GP	Anchorage	200	18B / C	12.0		63,439	853	0	40,613	104,905	0
25-0431	Micro/Net Sp I	FT	A	GP	Anchorage	200	18K / L	12.0		78,952	1,061	0	45,950	125,963	0
25-0602	Micro/Net Sp I	FT	A	GP	Juneau	205	18A / B	12.0		64,671	869	0	41,037	106,577	0
25-0959	Micro/Net Sp I	FT	A	GP	Ketchikan	200	18K	12.0		78,527	1,055	0	45,804	125,386	0
25-1376	Data Processing Manager I	FT	A	SS	Fairbanks	203	22A / B	12.0		87,656	0	6,032	51,059	144,747	0
25-1462	Micro/Net Sp I	FT	A	GP	Fairbanks	203	18J	12.0		78,332	1,059	432	45,885	125,708	0
25-1561	Micro/Net Sp I	FT	A	GG	Fairbanks	203	18M	12.0		86,229	1,165	432	48,602	136,428	0
25-1610	Micro/Net Sp II	FT	A	GP	Fairbanks	203	20G / J	12.0		86,200	1,164	432	48,592	136,388	0
25-2297	Micro/Net Sp I	FT	A	GP	Fairbanks	203	18K	12.0		80,886	1,087	0	46,615	128,588	0
25-2496	Micro/Net Sp II	FT	A	GP	Juneau	205	20G	12.0		87,575	1,177	0	48,916	137,668	0
25-2554	DPT Tech Ofcii	FT	A	SS	Anchorage	200	25B / C	12.0		108,125	0	0	56,025	164,150	0
25-2938	Systems Programmer III	FT	A	SS	Anchorage	200	23F	12.0		105,768	0	8,032	57,977	171,777	0
25-3342	Micro/Net Sp I	FT	A	GP	Ketchikan	200	18G / J	12.0		75,424	1,020	432	44,885	121,761	0
25-3596	Micro/Net Tc II	FT	A	GP	Anchorage	200	16A / B	12.0		52,899	743	2,389	37,809	93,840	0
25-3738	Data Processing Manager II	FT	A	SS	Juneau	205	23F	12.0		111,051	0	0	57,032	168,083	0
25-3769	Micro/Net Tc II	FT	A	GP	Anchorage	200	16C / D	12.0		57,351	796	1,858	39,158	99,163	0
25-3770	Micro/Net Tc II	FT	A	GP	Anchorage	200	16E / F	12.0		60,410	812	0	39,571	100,793	0

Note: If a position is split, an asterisk (*) will appear in the Split/Count column. If the split position is also counted in the component, two asterisks (**) will appear in this column.
 [No valid job title] appearing in the Job Class Title indicates that the PCN has an invalid class code or invalid range for the class code effective date of this scenario.

Personal Services Expenditure Detail
Department of Administration

Scenario: FY2022 Governor (17280)
Component: Alaska Division of Information Technology (3141)
RDU: Office of Information Technology (653)

PCN	Job Class Title	Time Status	Retire Code	Barg Unit	Location	Salary Sched	Range / Step	Comp Months	Split / Count	Annual Salaries	COLA	Premium Pay	Annual Benefits	Total Costs	UGF Amount
		Total Positions	New	Deleted										Total Salary Costs:	21,641,028
														Total COLA:	181,095
	Full Time Positions:	240	0	0										Total Premium Pay:	434,803
	Part Time Positions:	0	0	0										Total Benefits:	12,072,380
	Non Permanent Positions:	0	0	0											
	Positions in Component:	240	0	0											
	Total Component Months:	2,880.0													
														Total Pre-Vacancy:	34,329,306
														Minus Vacancy Adjustment of 6.77%:	(2,323,306)
														Total Post-Vacancy:	32,006,000
														Plus Lump Sum Premium Pay:	0
														Personal Services Line 100:	32,006,000

<u>PCN Funding Sources:</u>	<u>Pre-Vacancy</u>	<u>Post-Vacancy</u>	<u>Percent</u>
1081 Information Services Fund	34,329,306	32,006,000	100.00%
Total PCN Funding:	34,329,306	32,006,000	100.00%

Note: If a position is split, an asterisk (*) will appear in the Split/Count column. If the split position is also counted in the component, two asterisks (**) will appear in this column. [No valid job title] appearing in the Job Class Title indicates that the PCN has an invalid class code or invalid range for the class code effective date of this scenario.

Department of Administration

Alaska Division of Information Technology (3141)

RDU: Office of Information Technology (653)

FY2022 Governor's Budget

Position Totals PFT - 240

OIT Senior Management

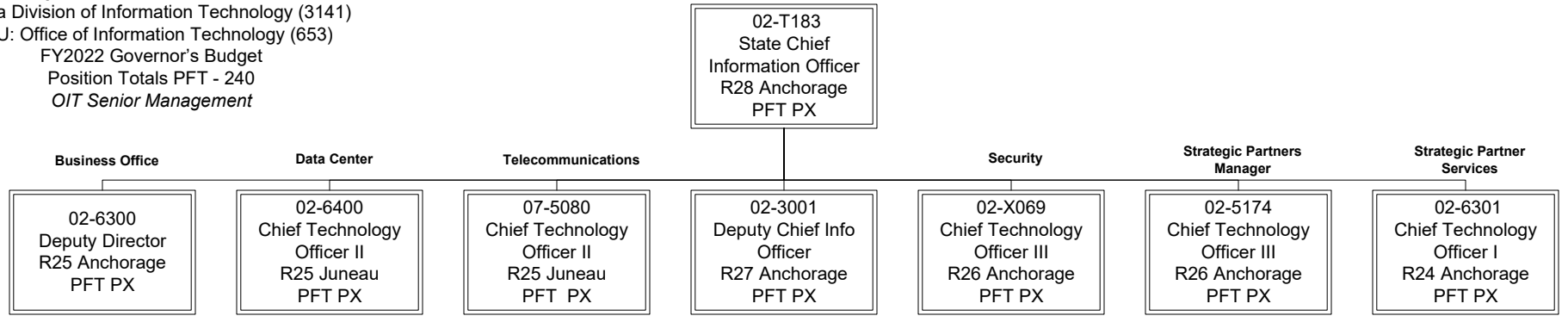

Department of Administration
Alaska Division of Information Technology (3141)
Department Technology Officers

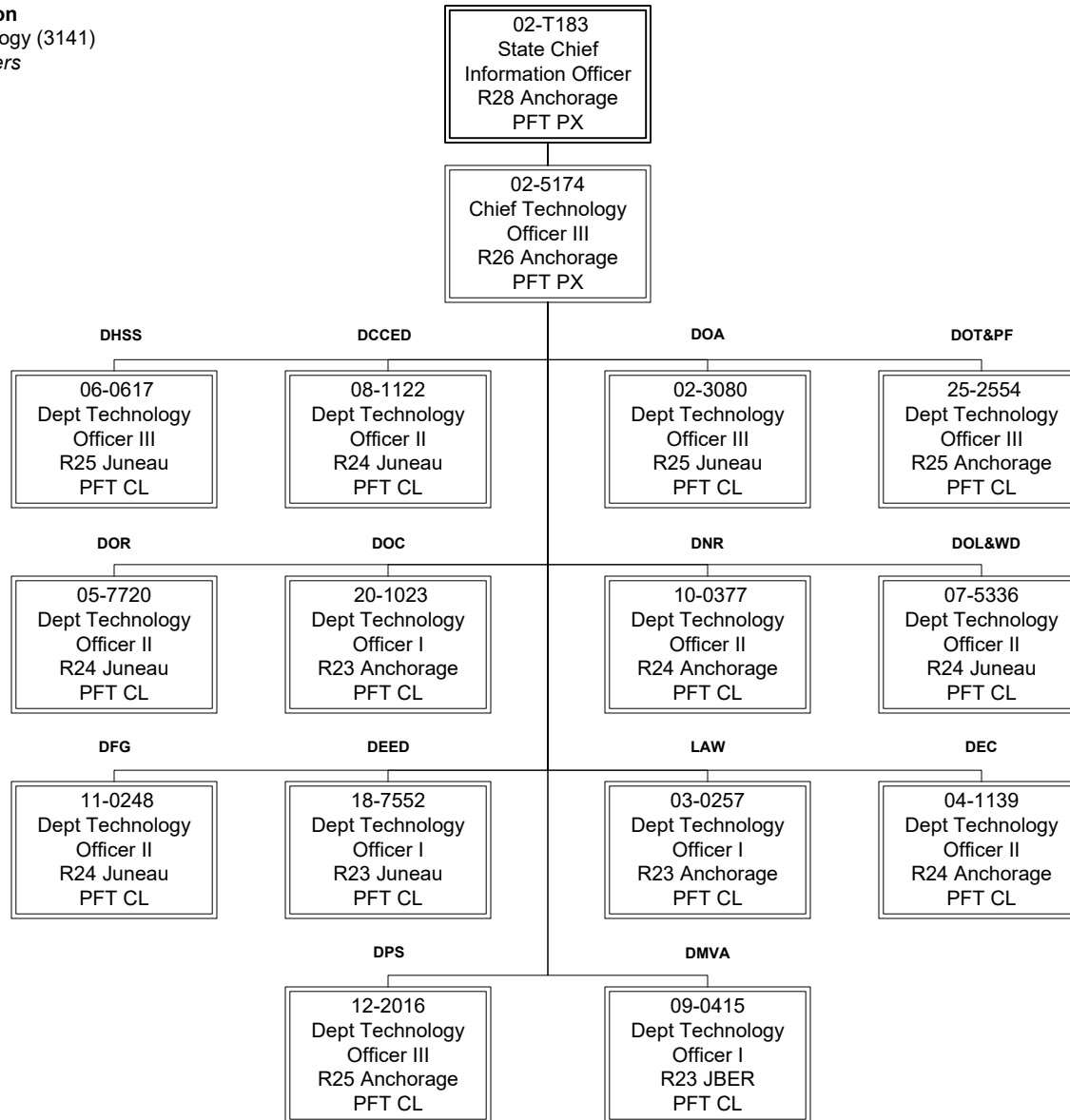

Department of Administration
Alaska Division of Information Technology (3141)
Business Office

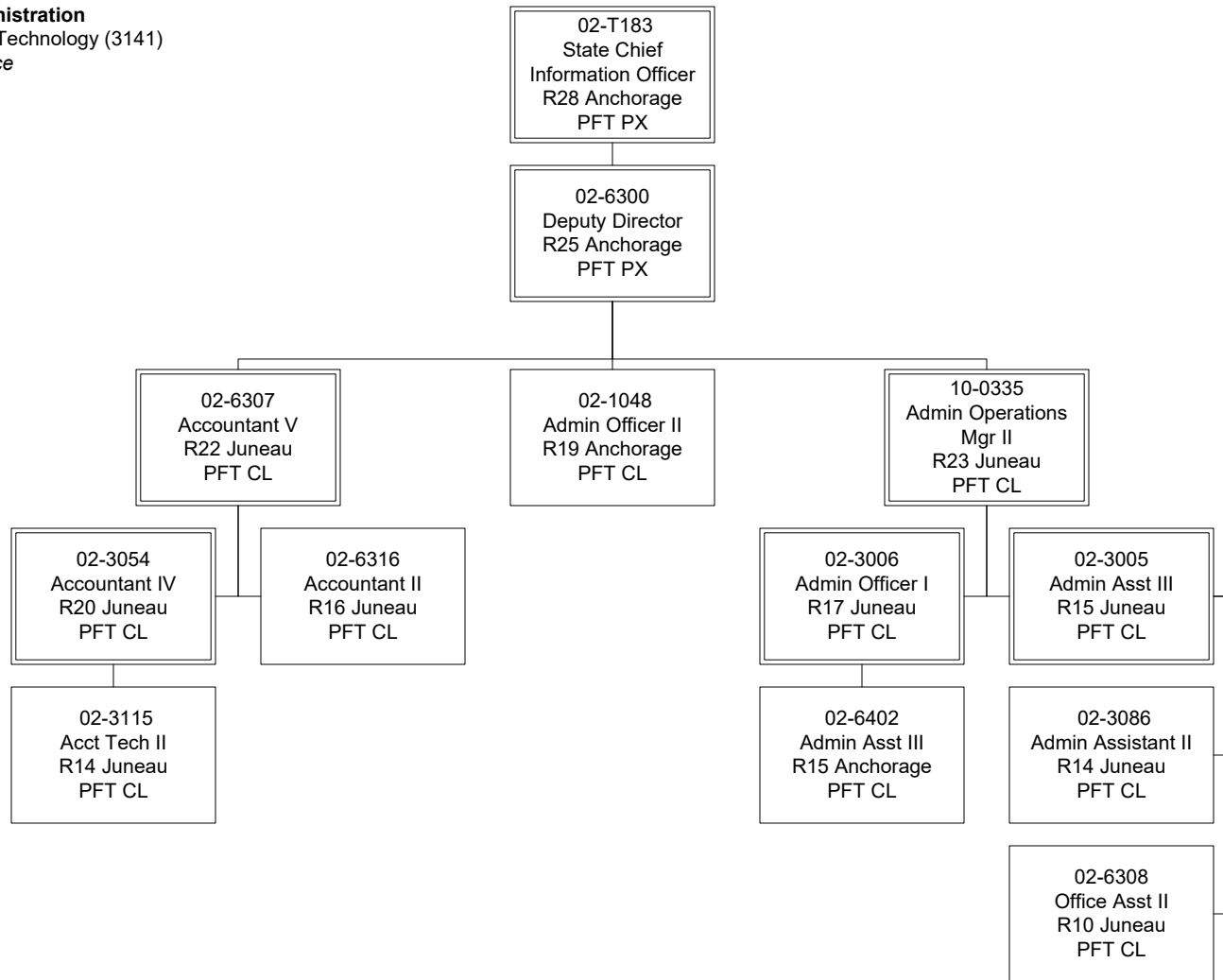

Department of Administration
Alaska Division of Information Technology (3141)
Portfolio, Planning, and Policy

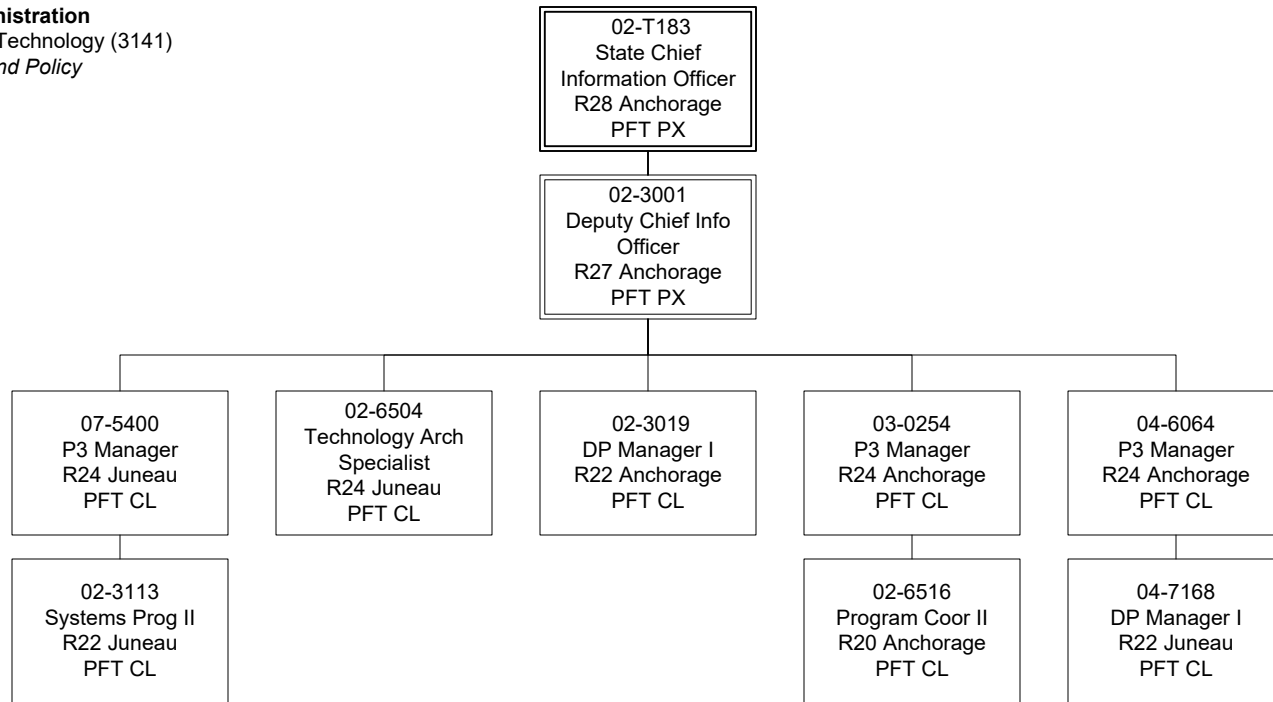

Department of Administration
Alaska Division of Information Technology (3141)
Security

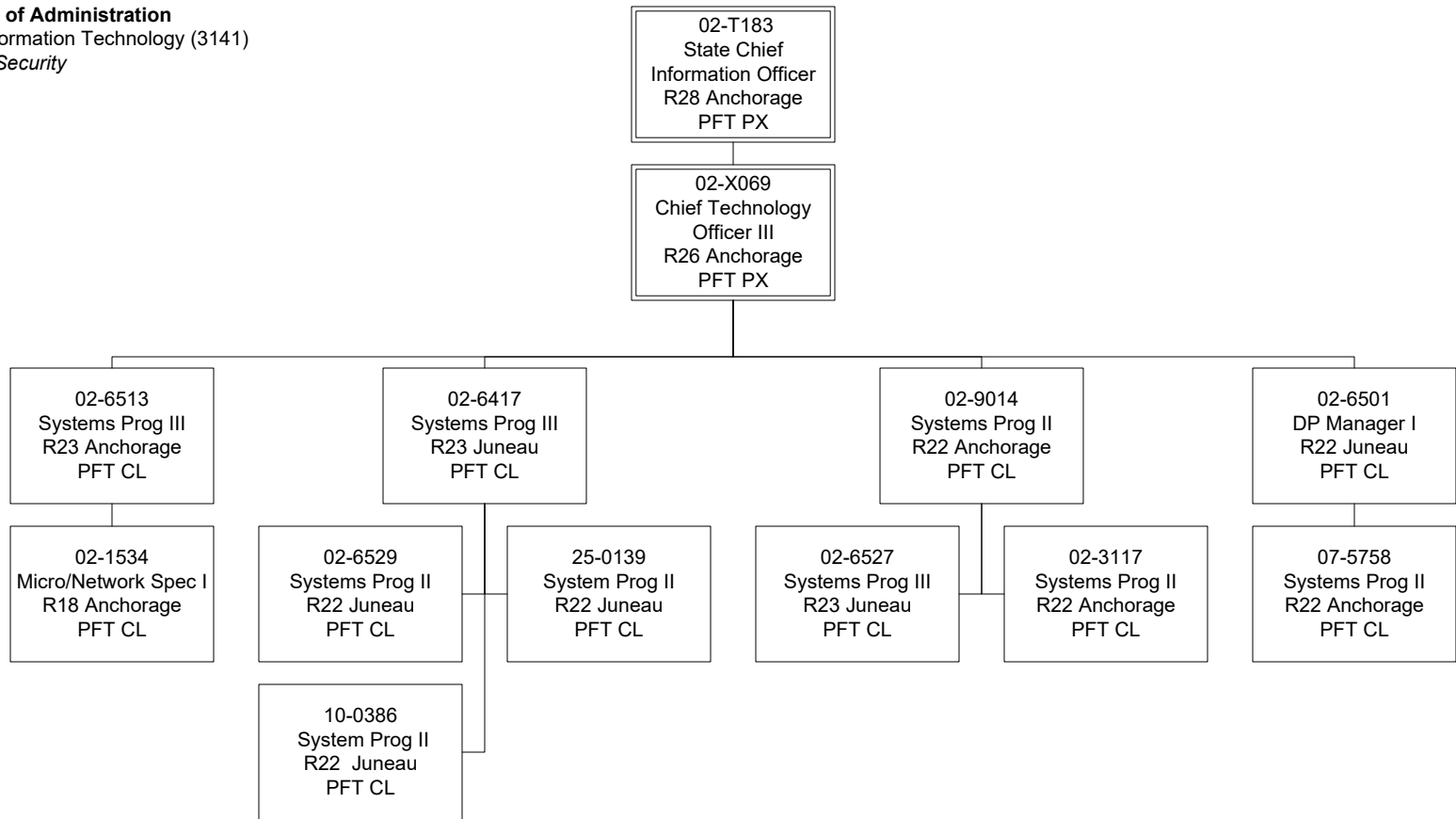

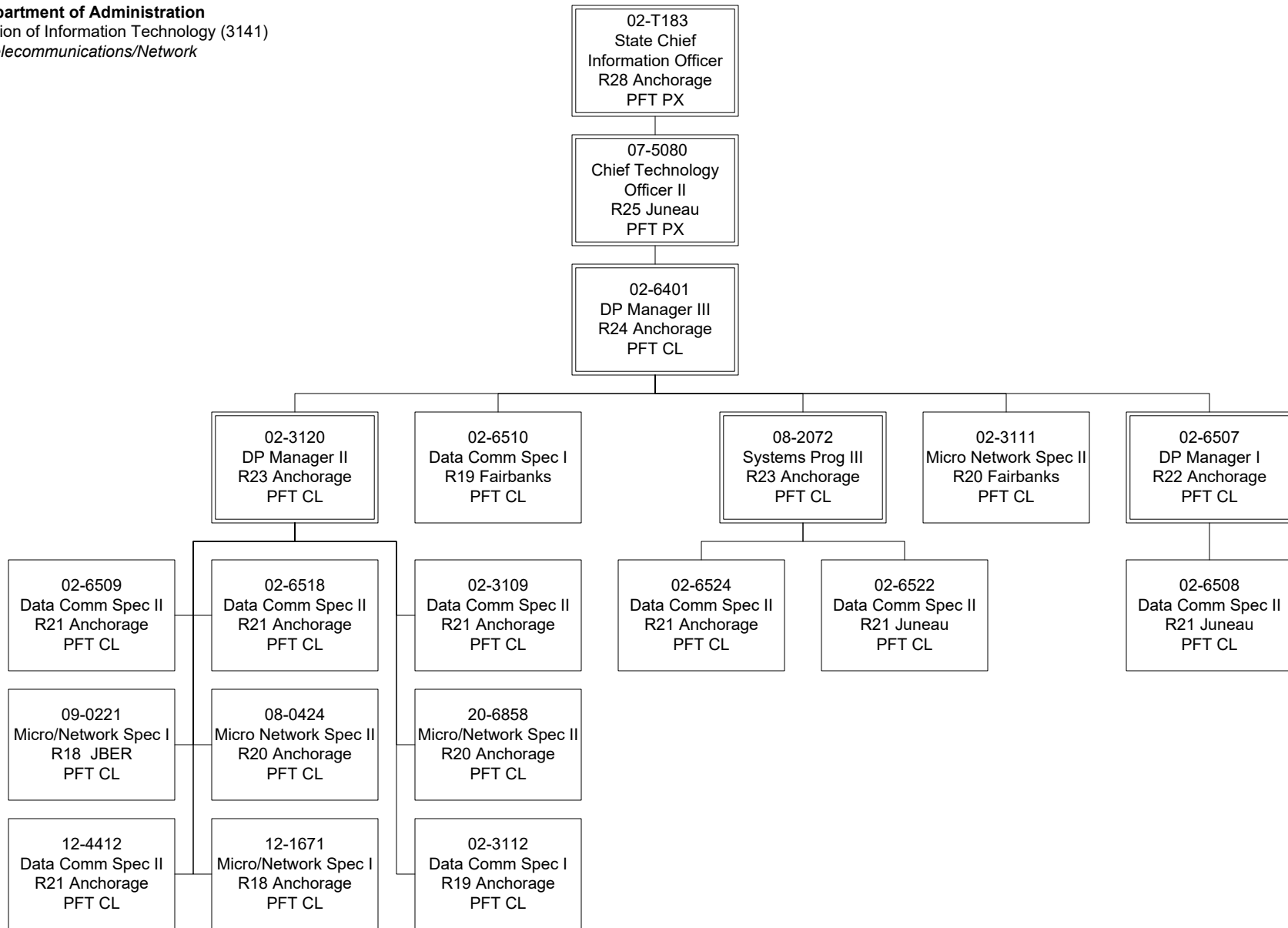

Department of Administration
 Alaska Division of Information Technology (3141)
SPS Systems PFT CLpport

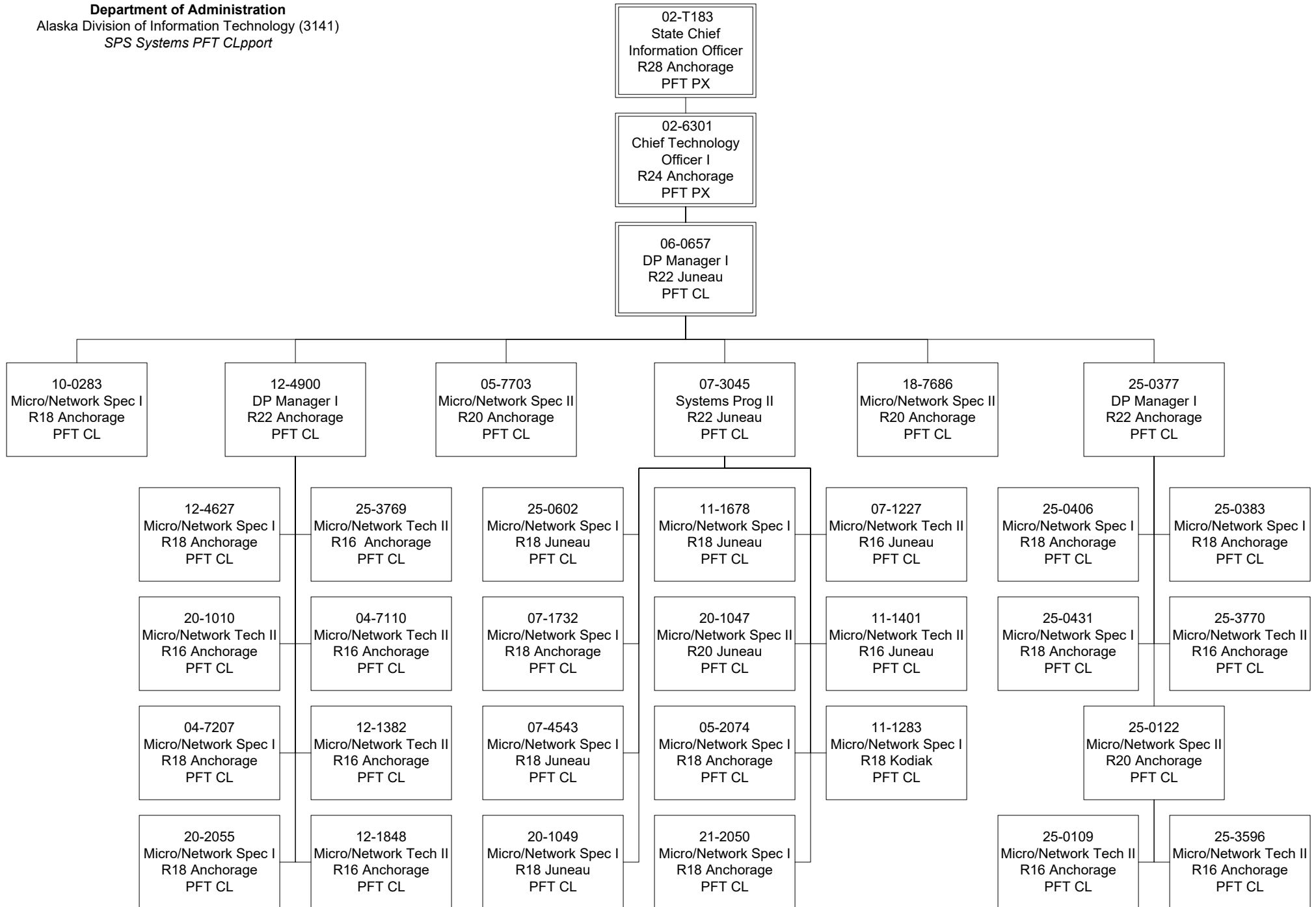

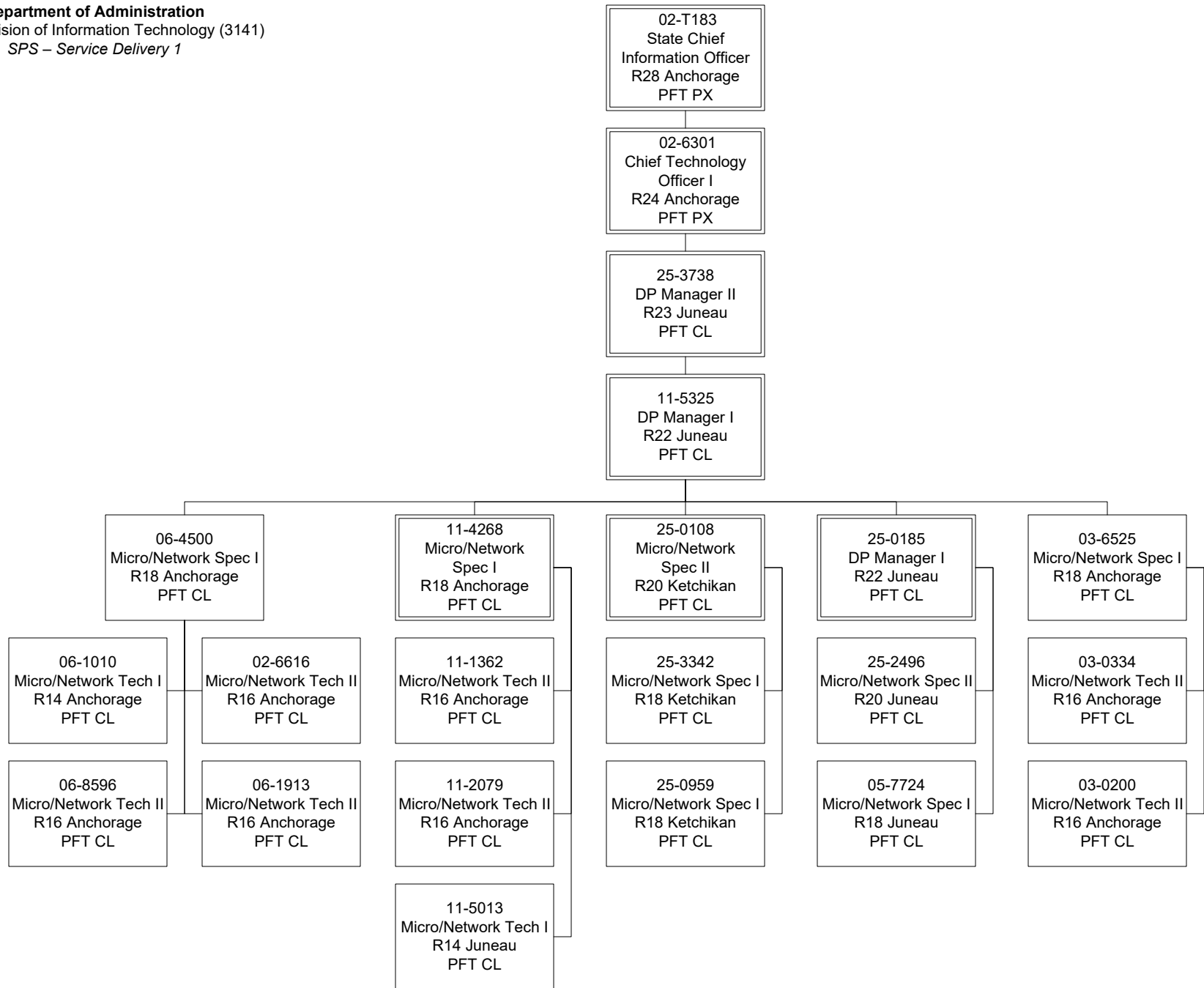

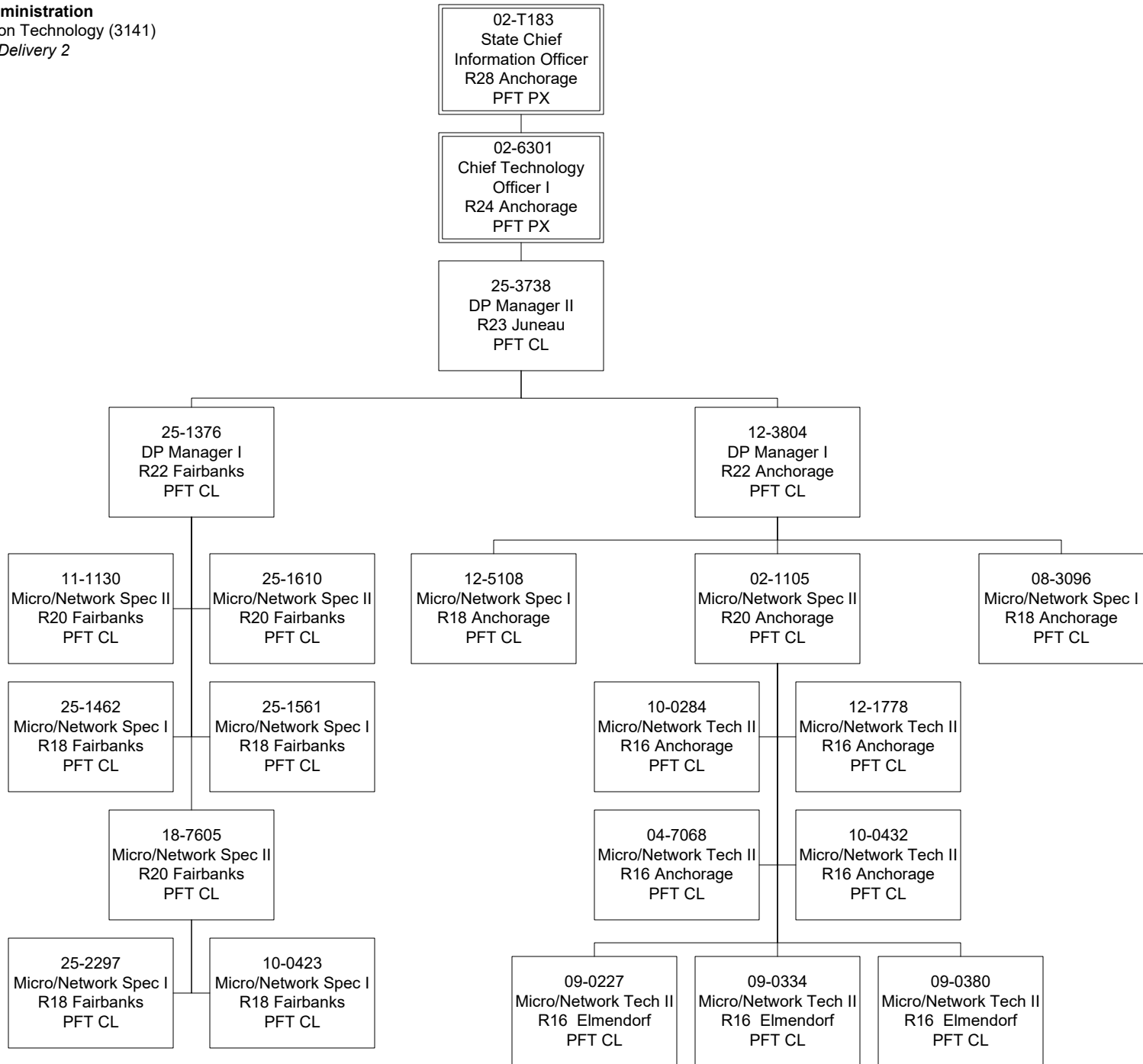

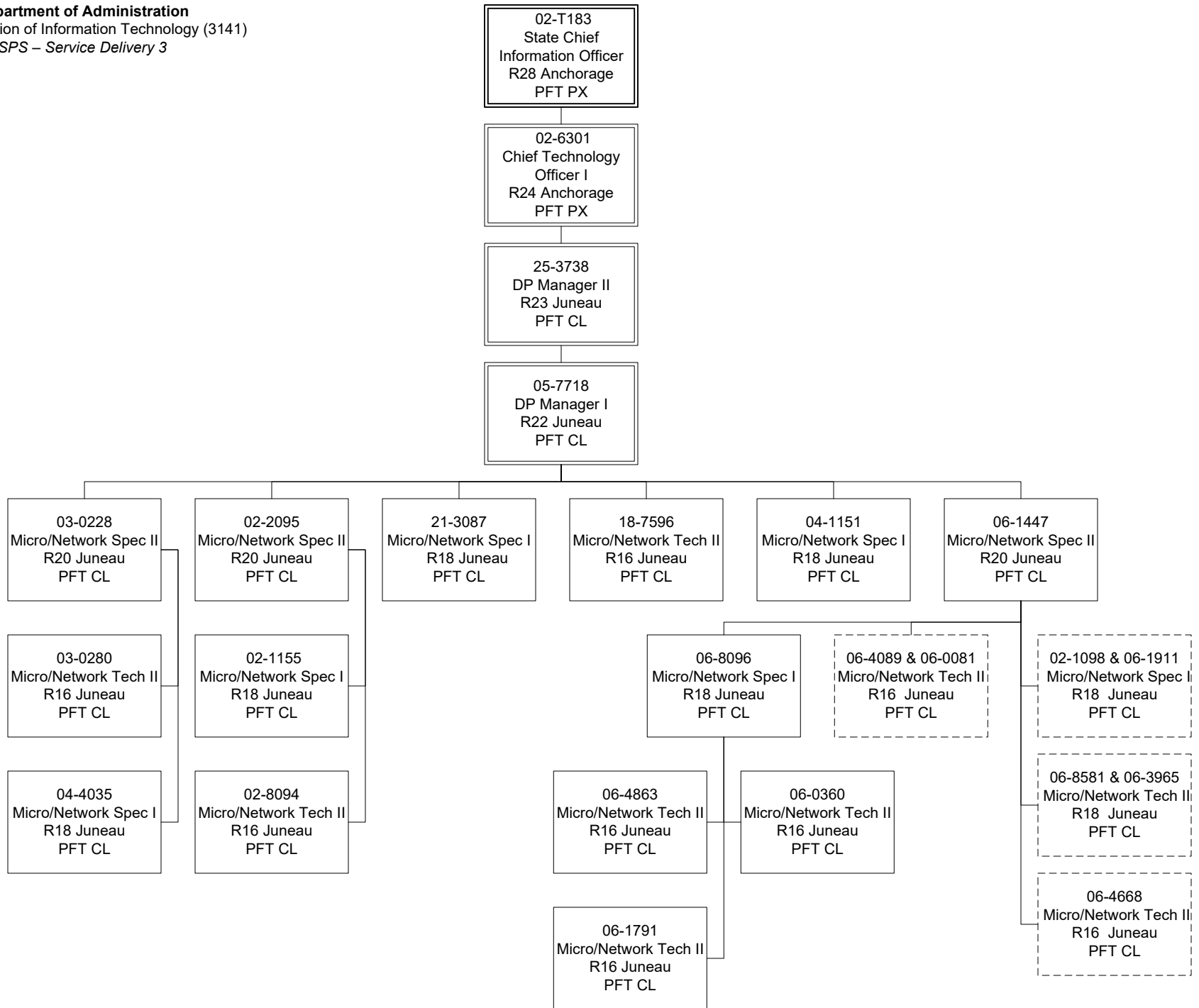

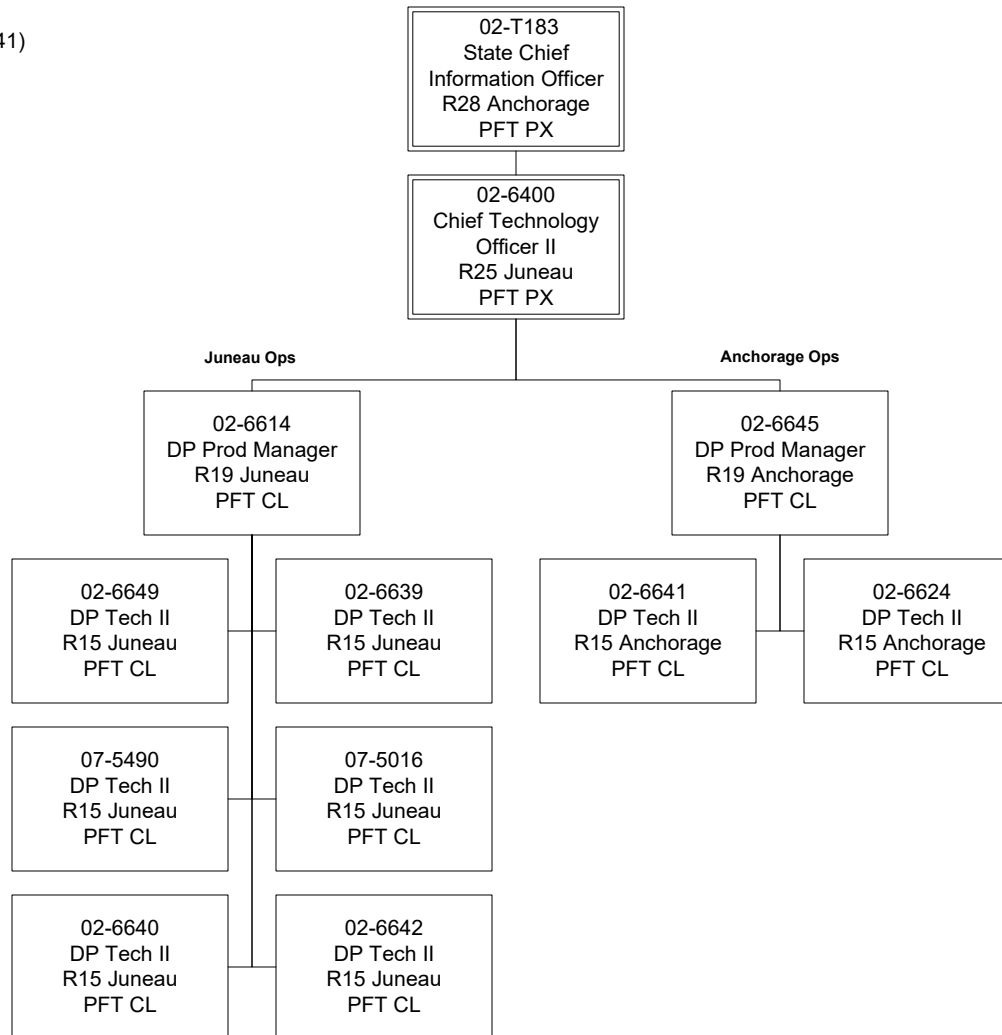

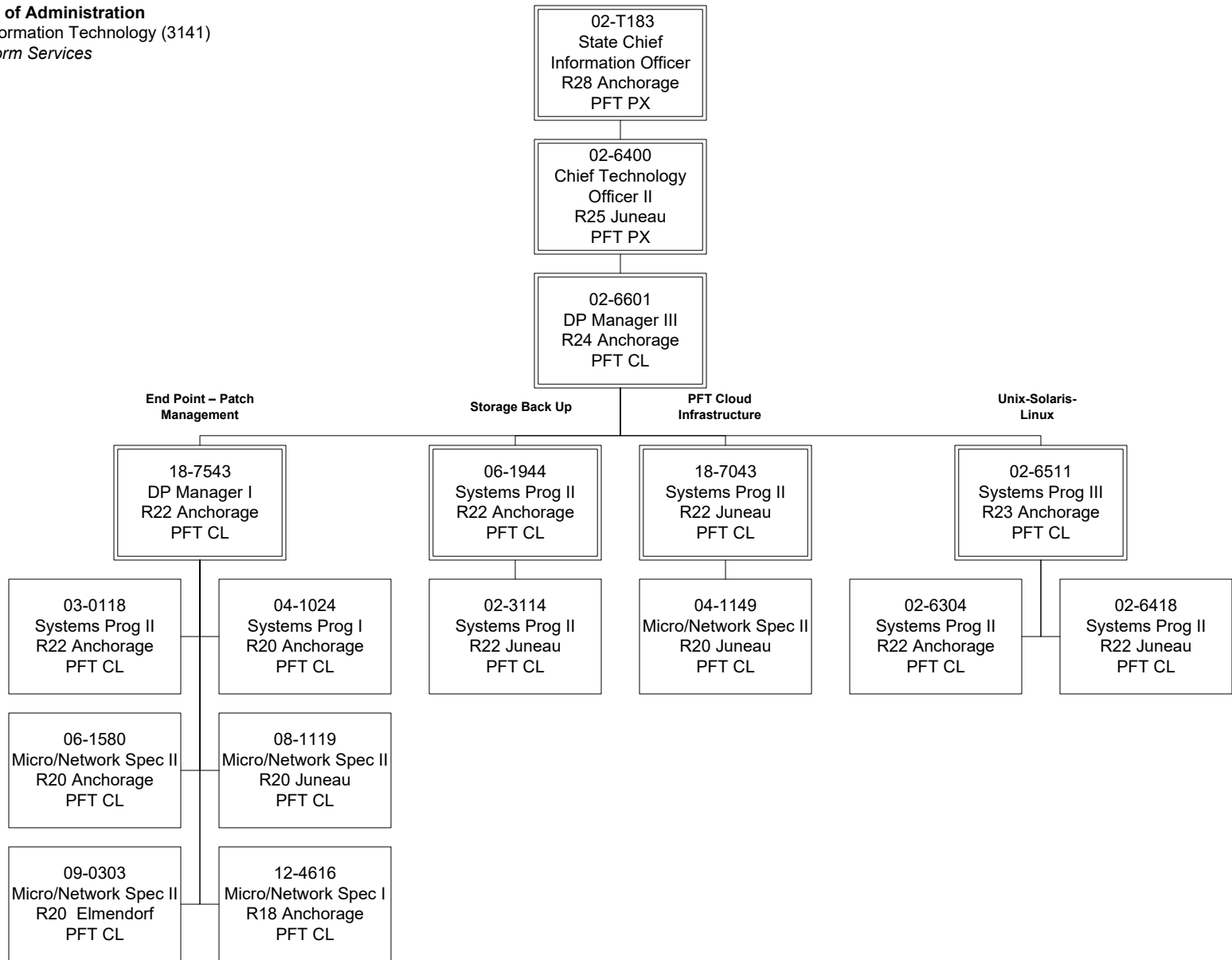

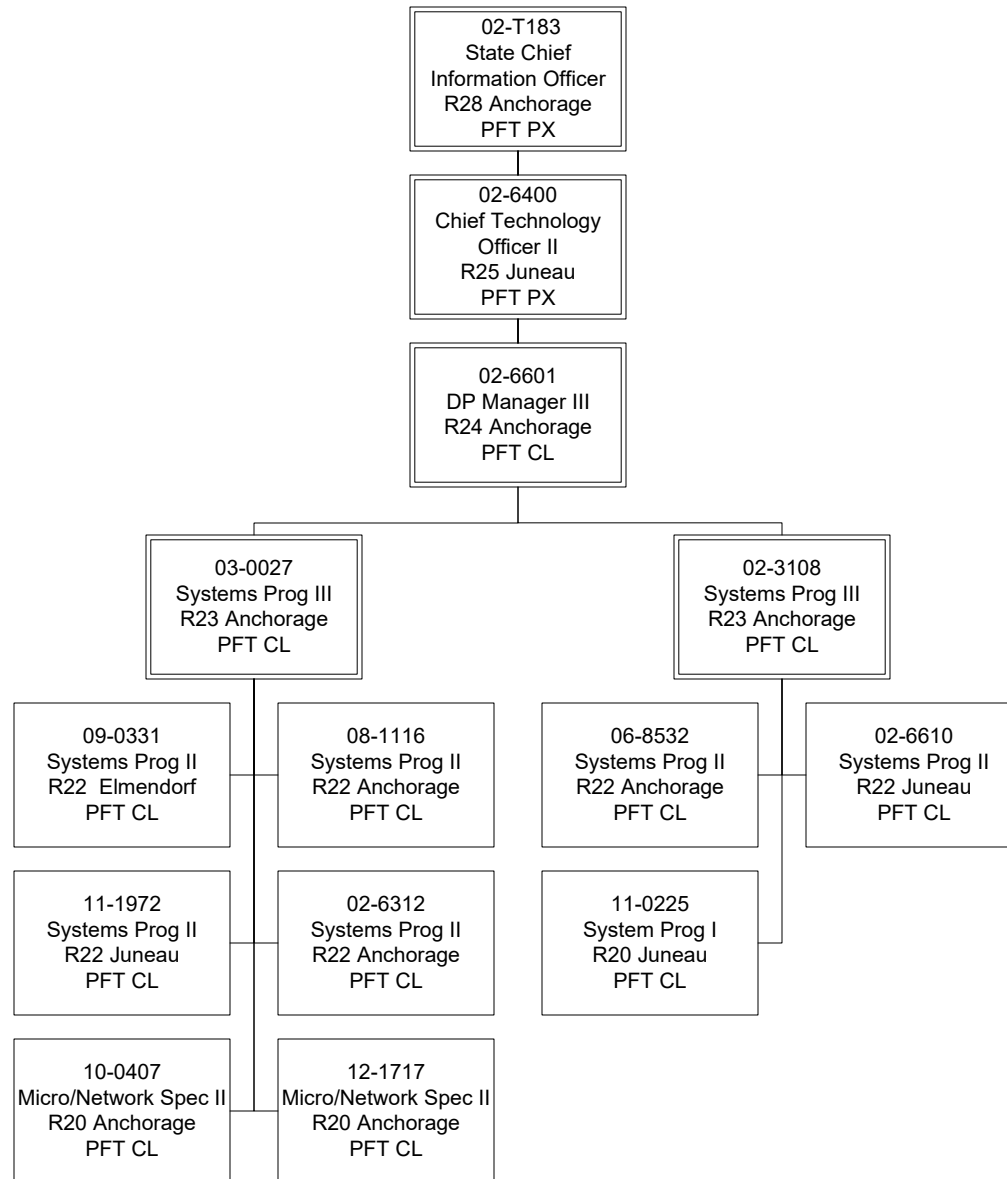

Department of Administration
Alaska Division of Information Technology (3141)
Platform Services – Database Services

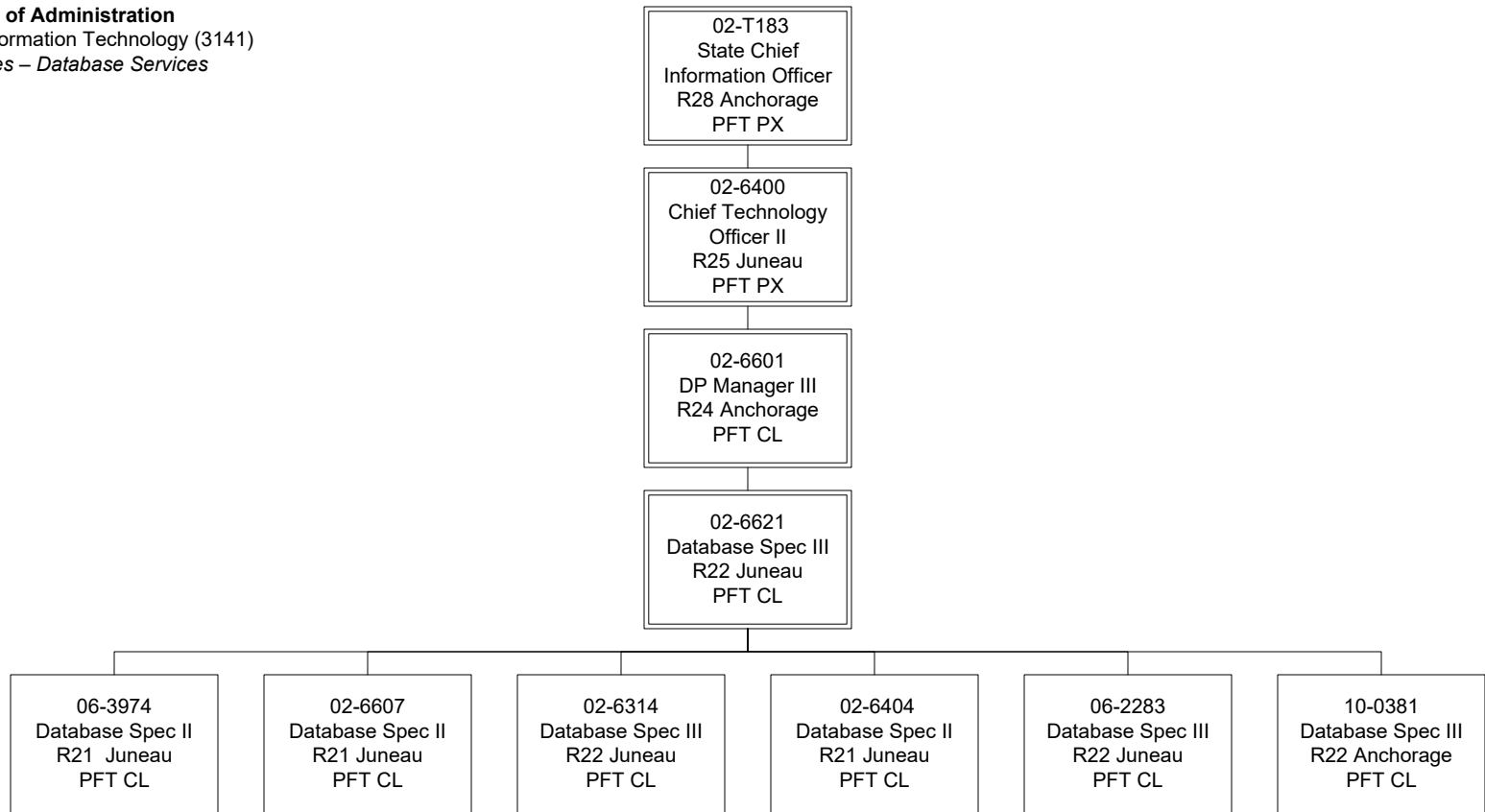

Department of Administration
 Alaska Division of Information Technology (3141)
Application Services

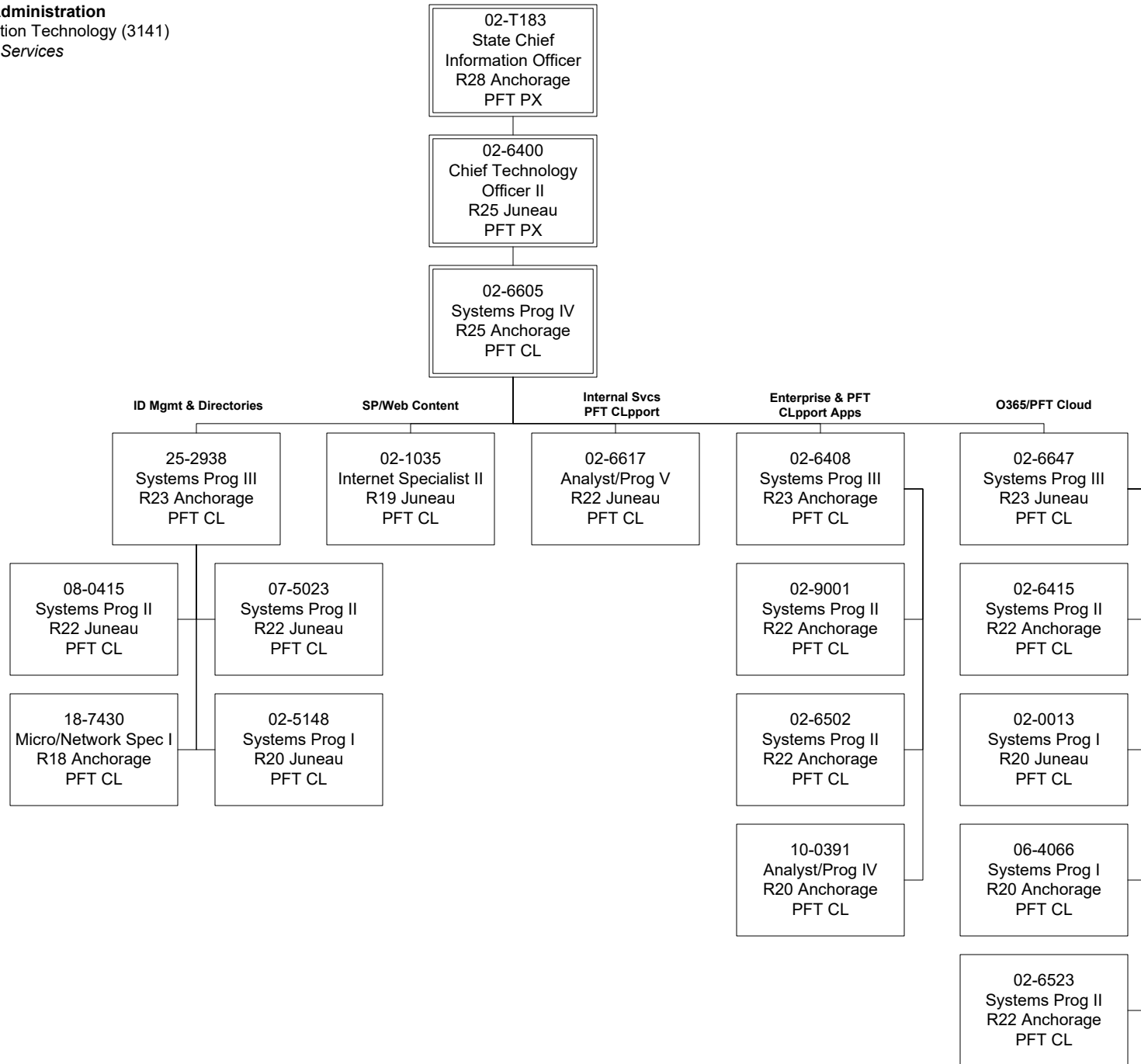

Department of Administration
Alaska Division of Information Technology (3141)
Mainframe Services

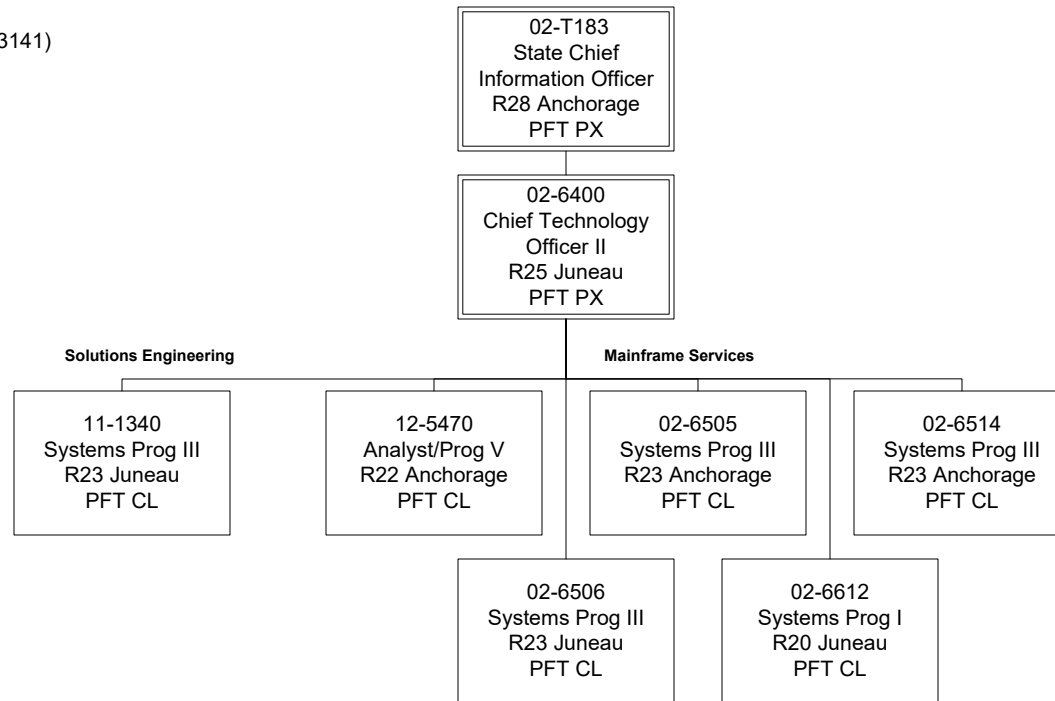

Department of Administration
 Alaska Division of Information Technology (3141)
Line of Business

