

Department of Administration

Alaska Division of Information Technology (3141)

RDU: Office of Information Technology (653)

FY2022 Governor's Budget

Position Totals PFT - 240

OIT Senior Management

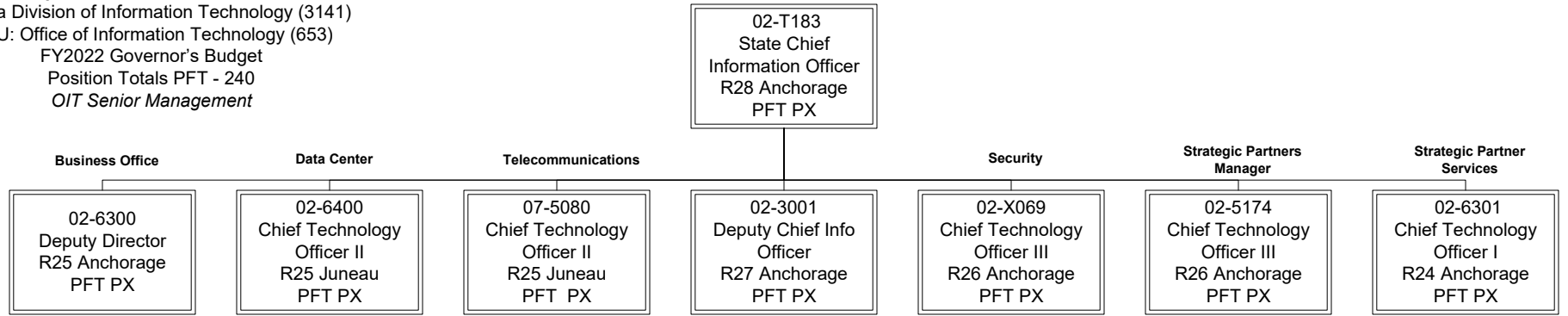

Department of Administration
Alaska Division of Information Technology (3141)
Department Technology Officers

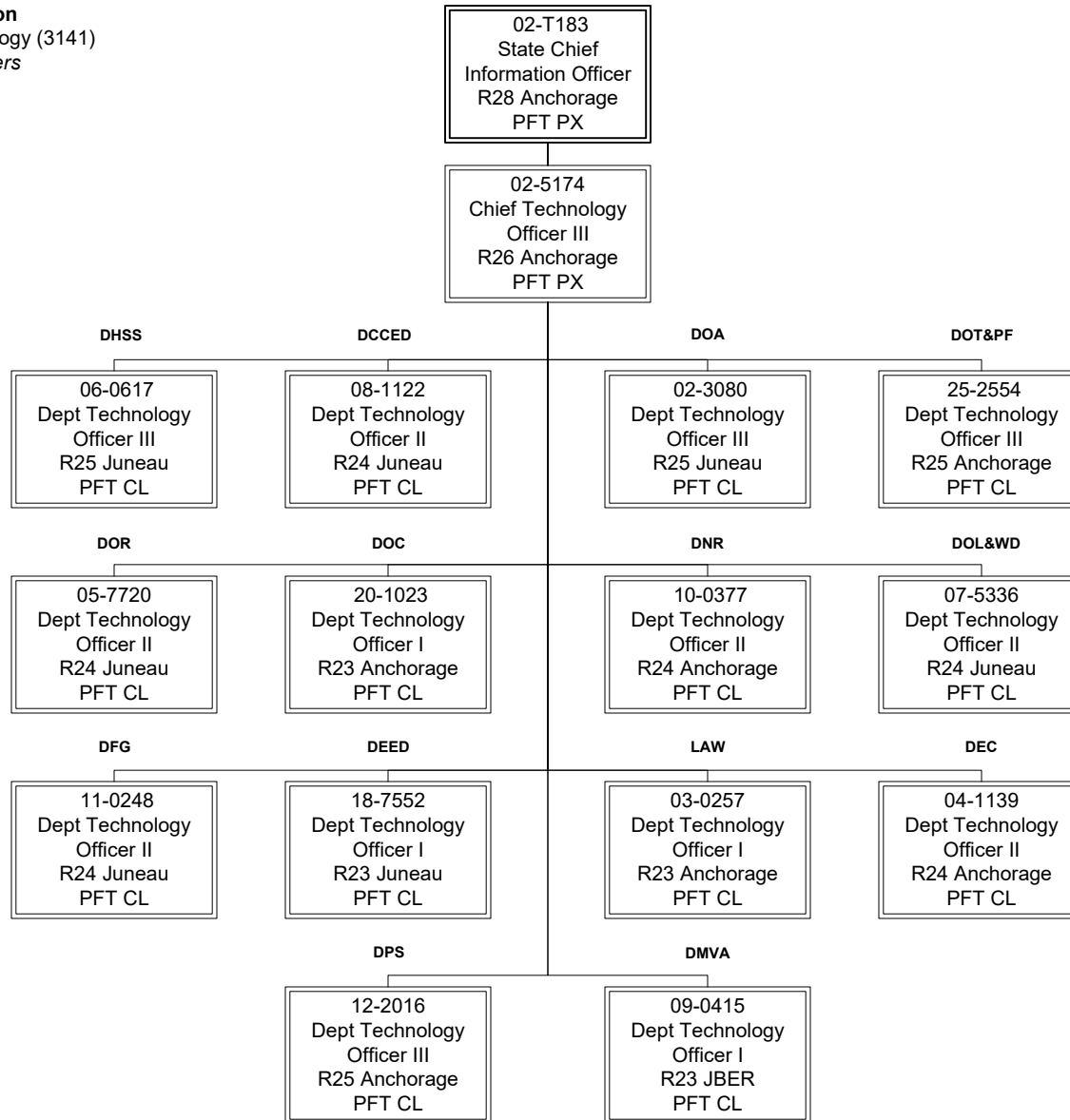

Department of Administration
Alaska Division of Information Technology (3141)
Business Office

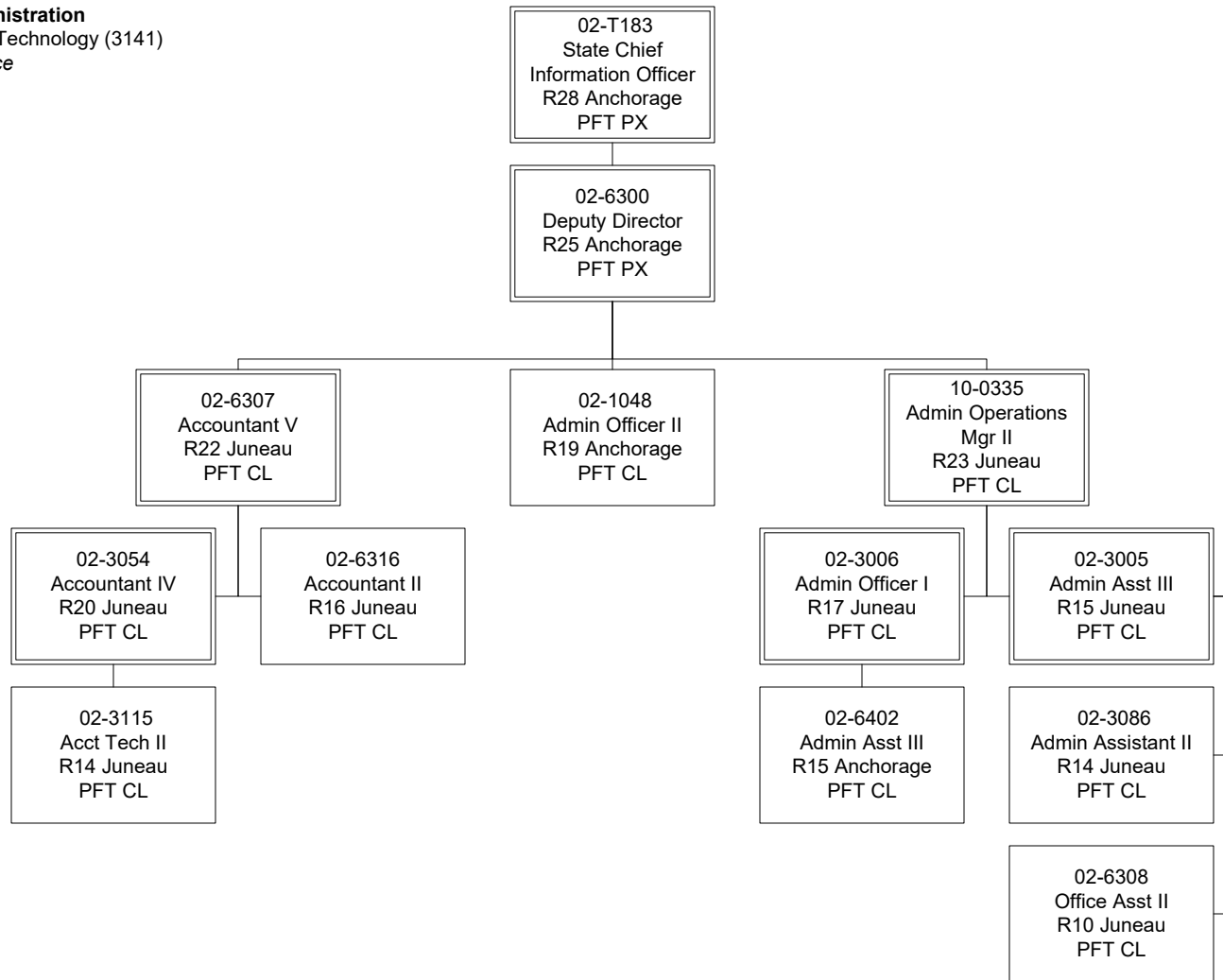

Department of Administration
Alaska Division of Information Technology (3141)
Portfolio, Planning, and Policy

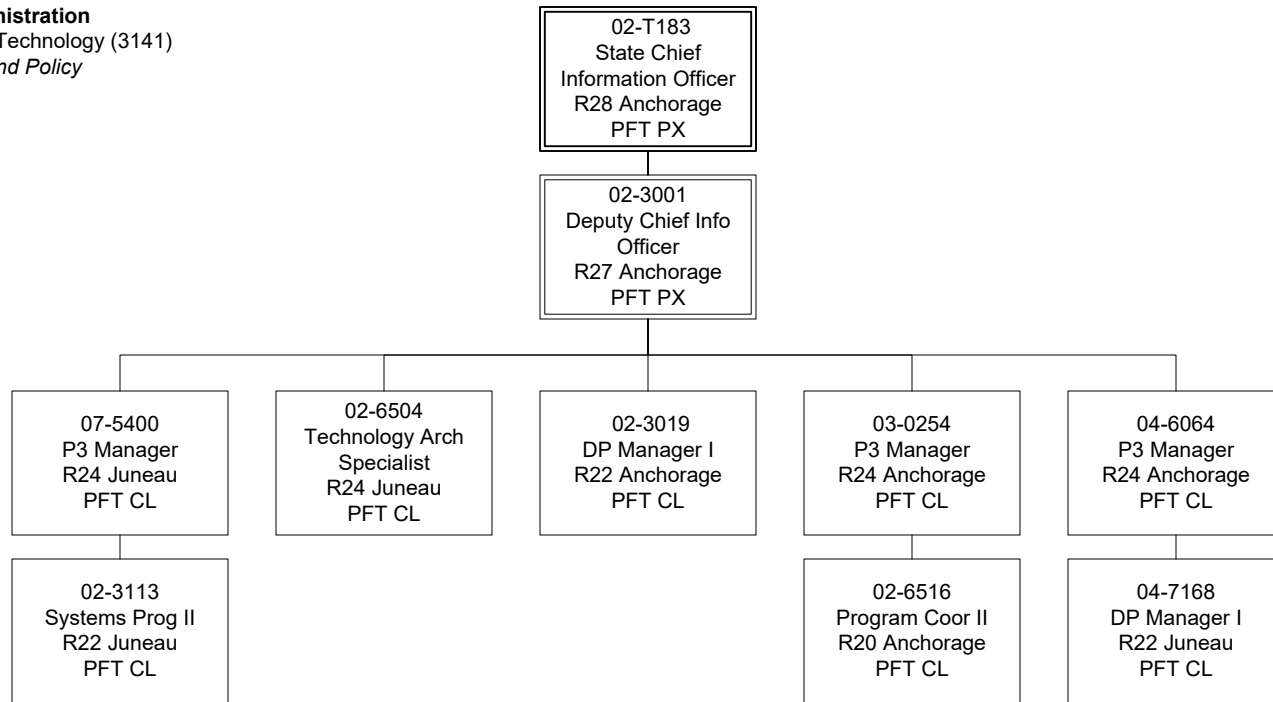

Department of Administration
Alaska Division of Information Technology (3141)
Security

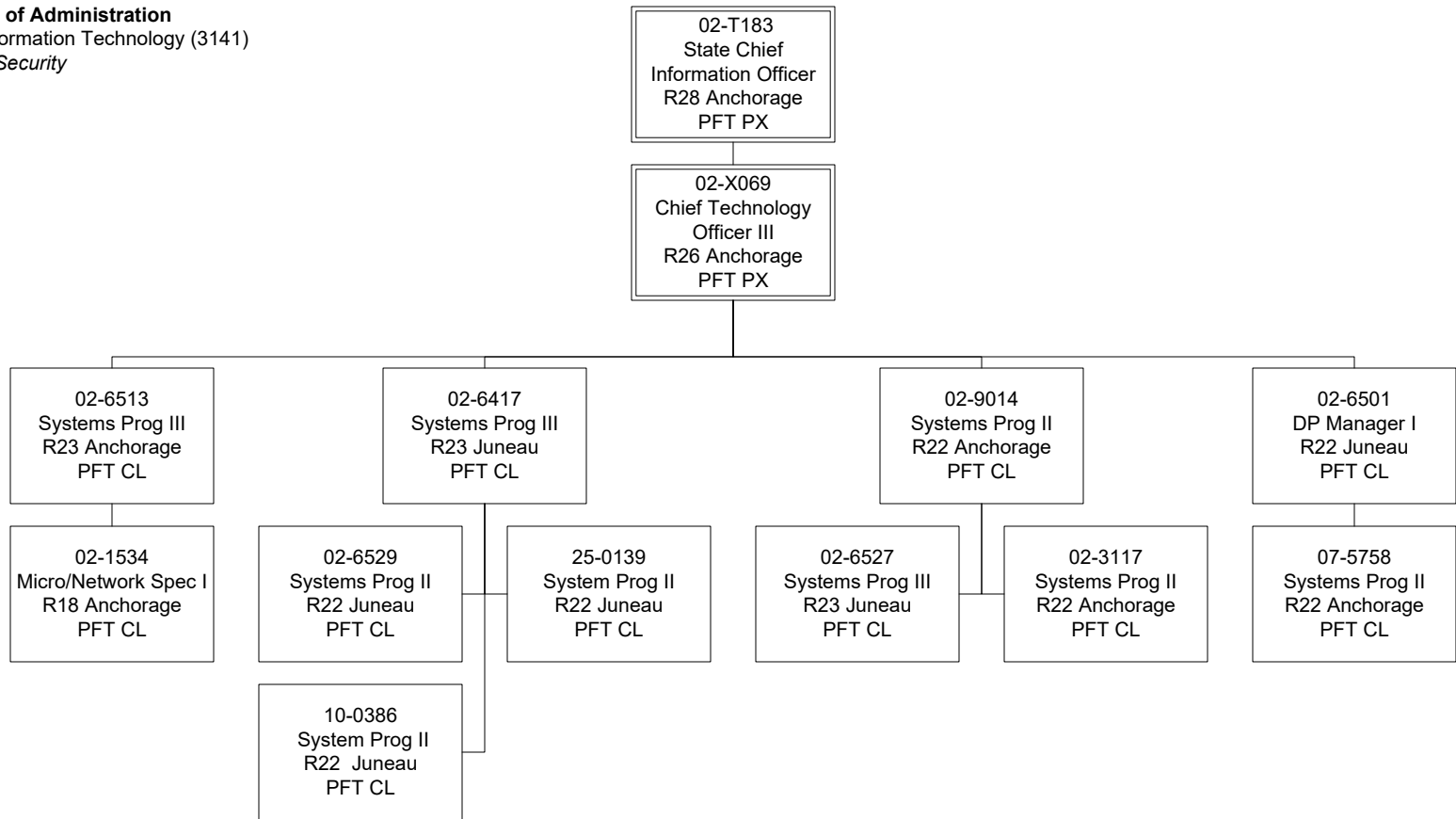

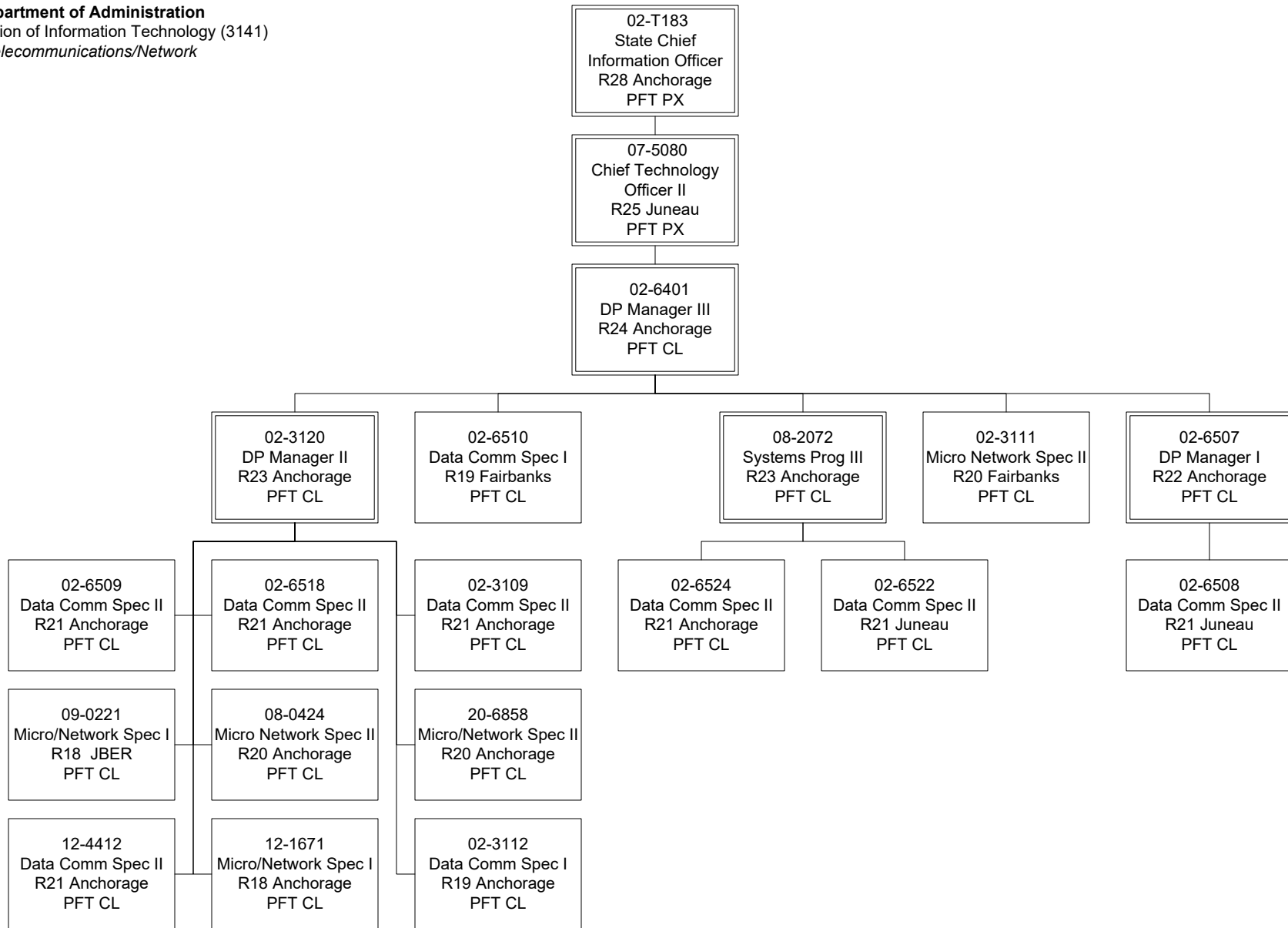

Department of Administration
 Alaska Division of Information Technology (3141)
SPS Systems PFT CLpport

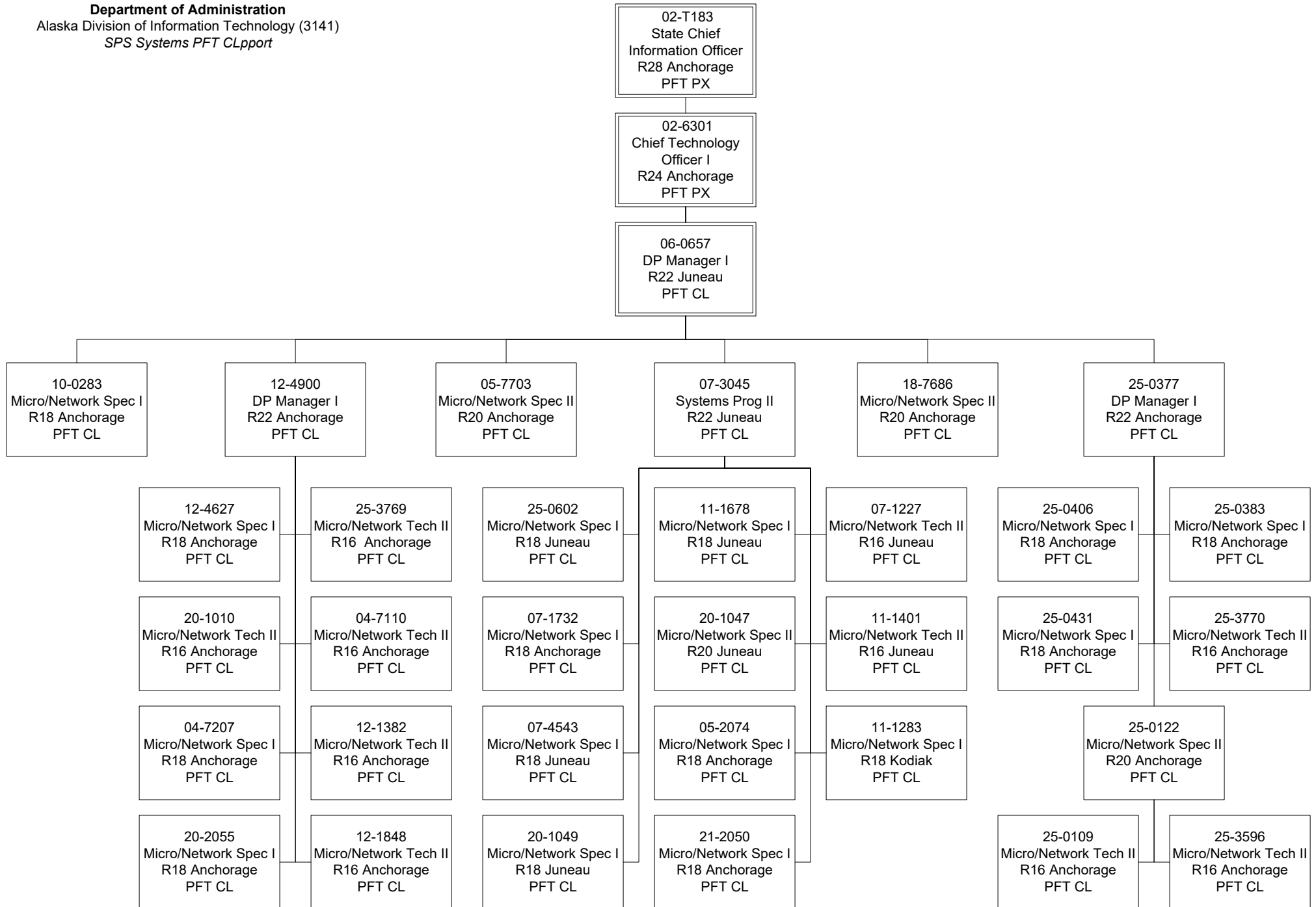

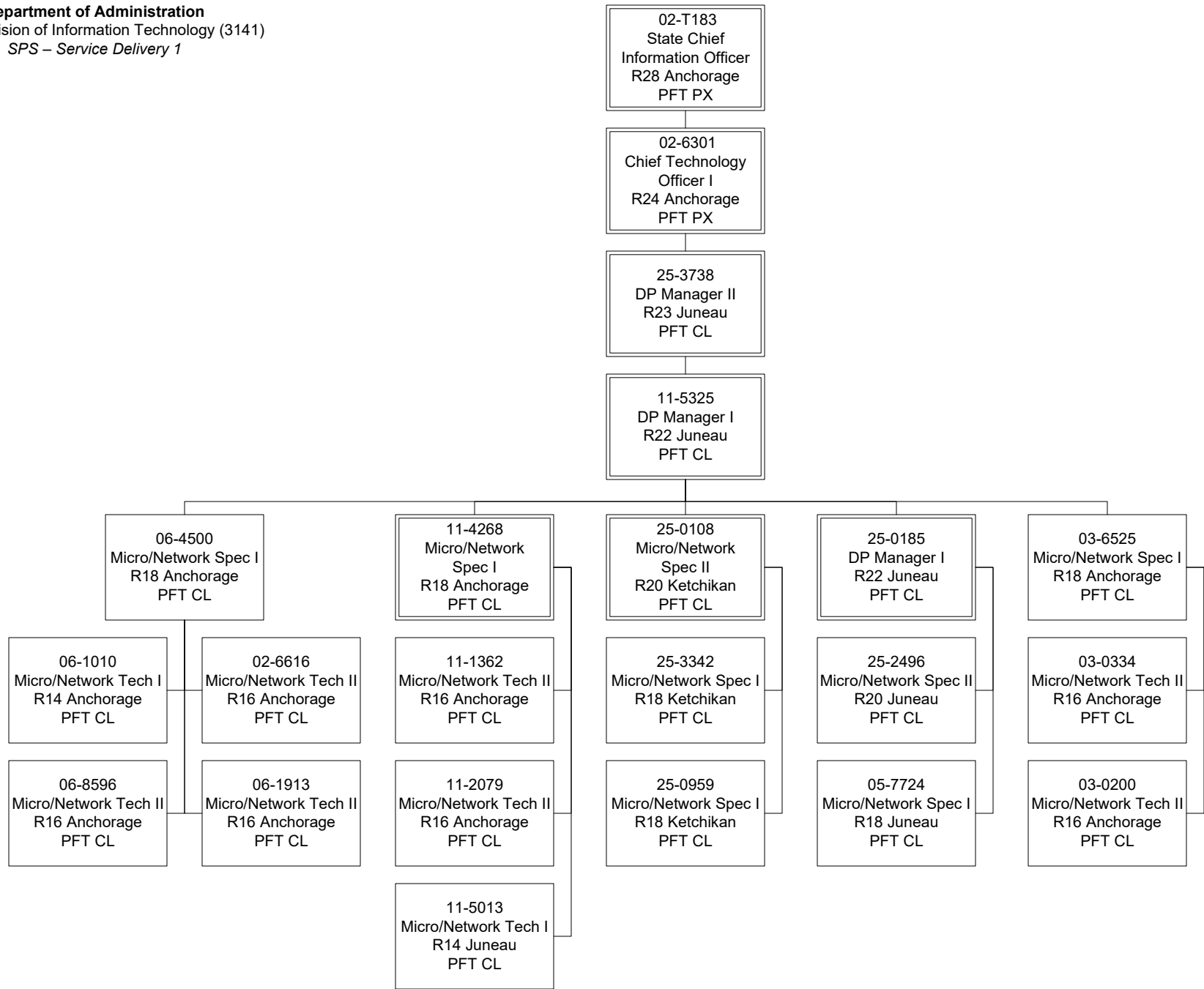

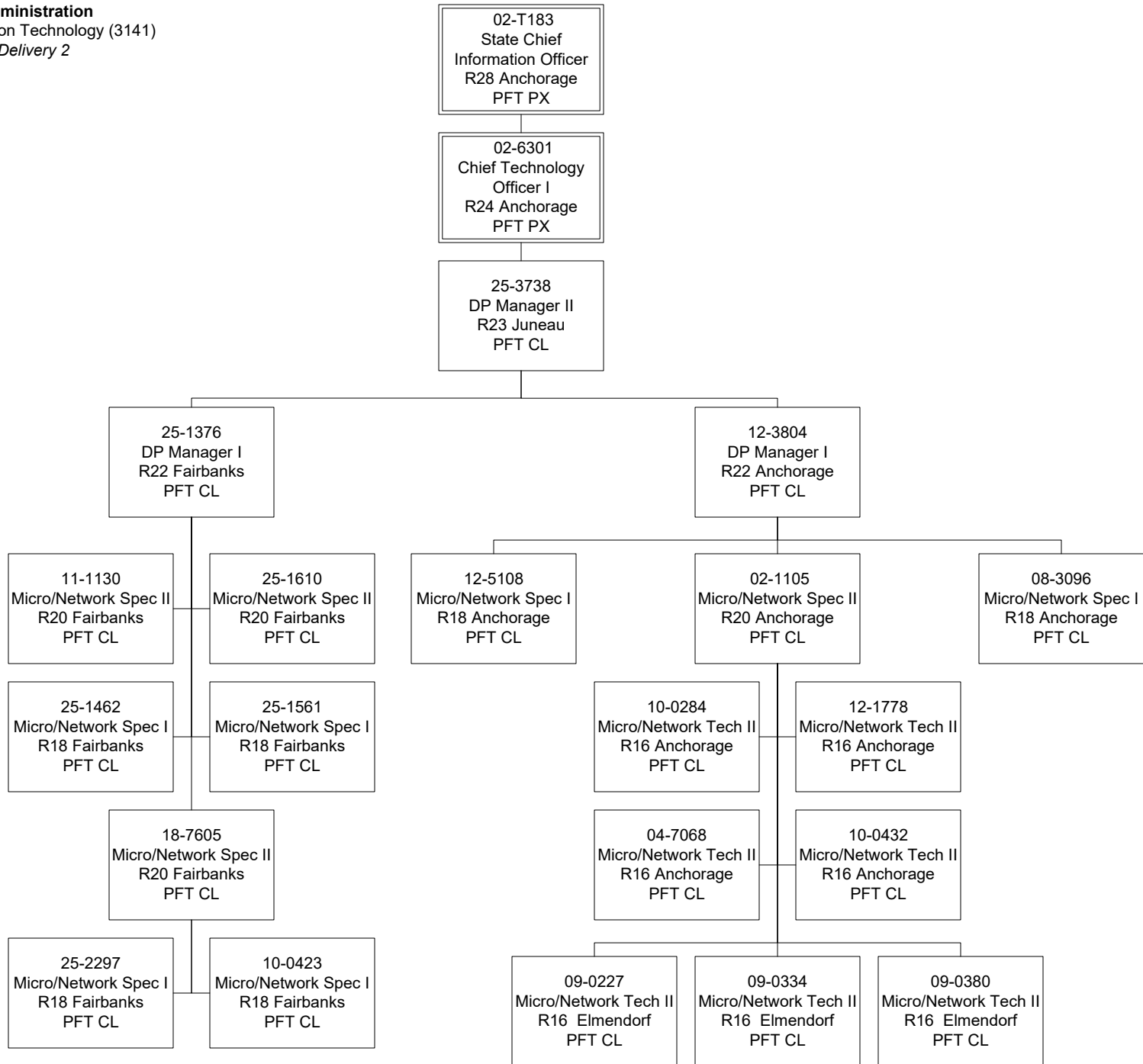

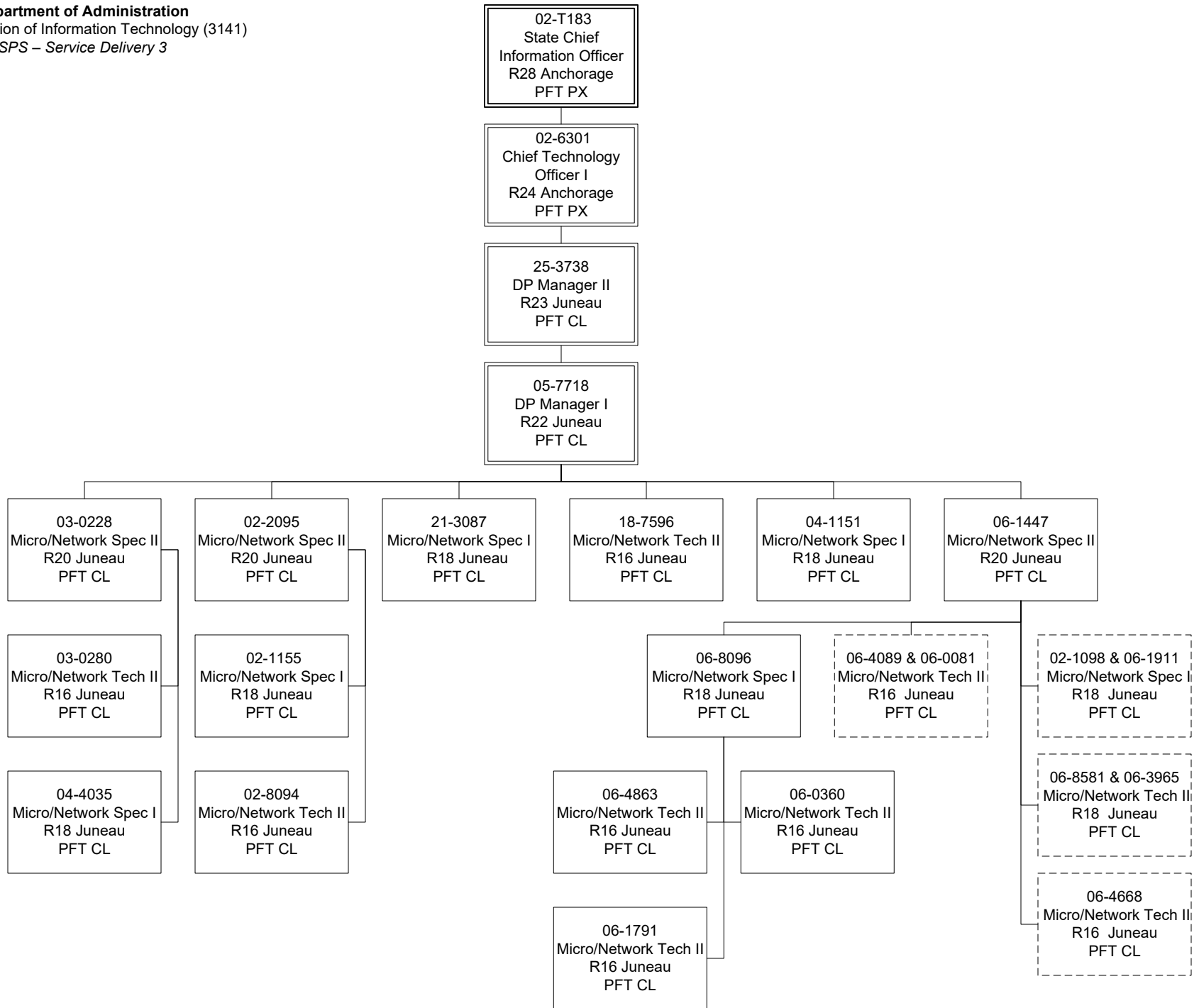

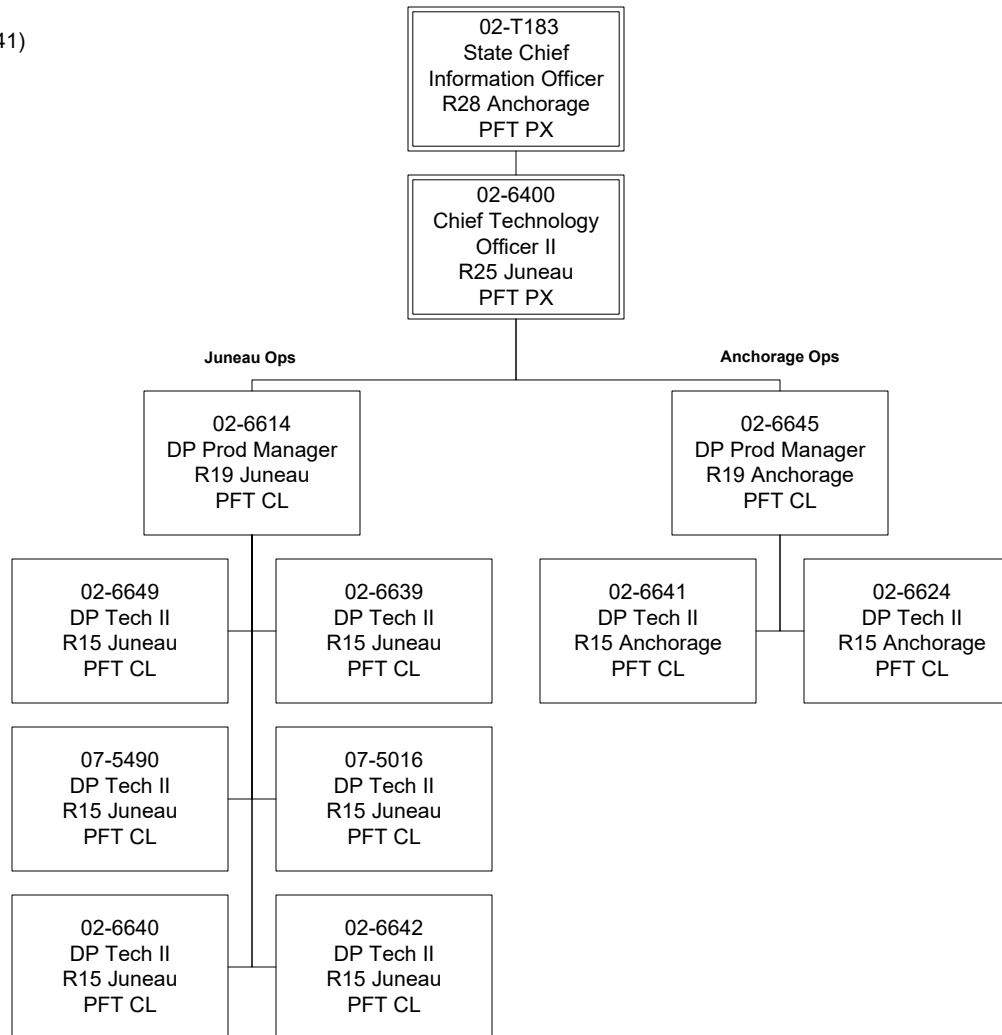

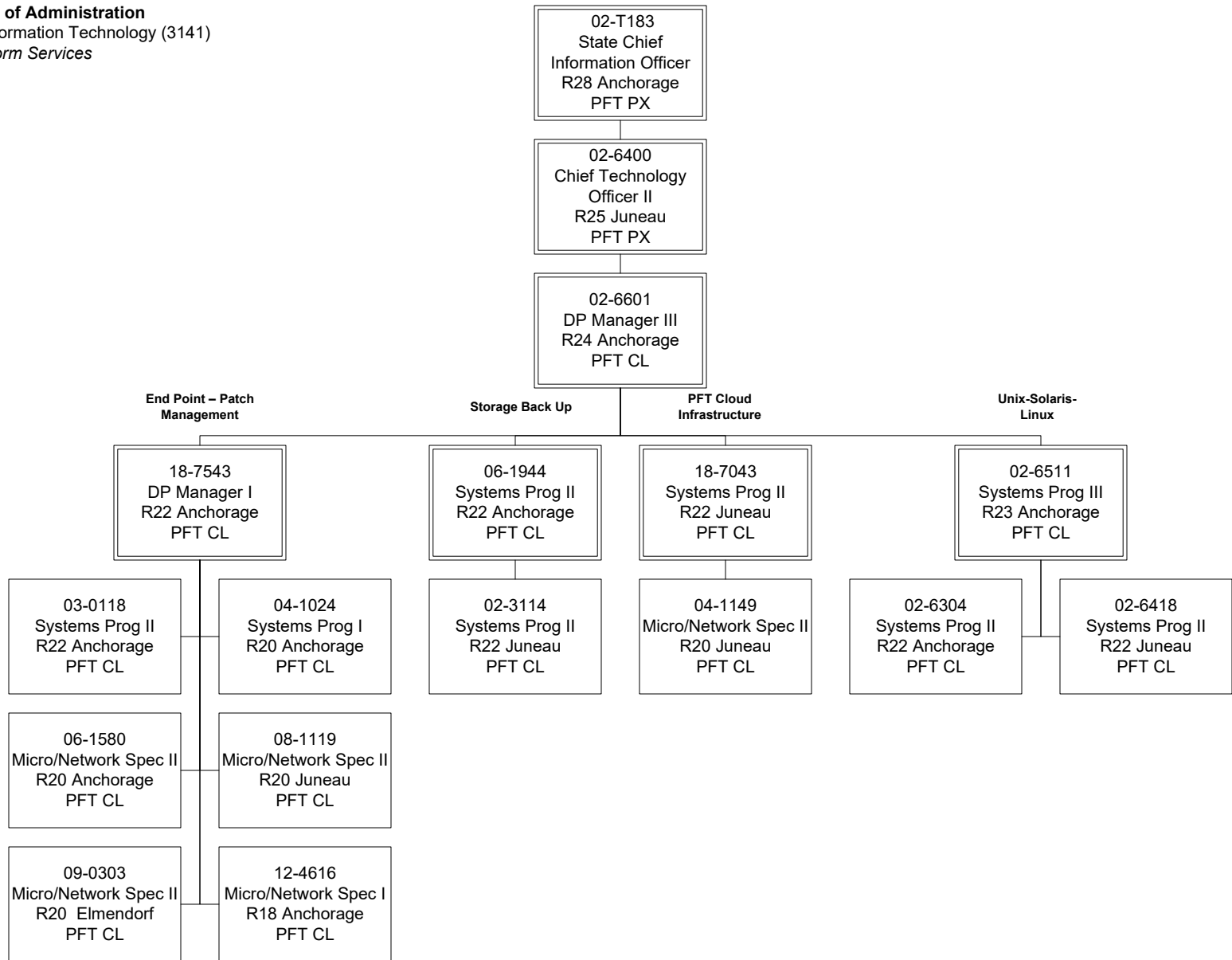

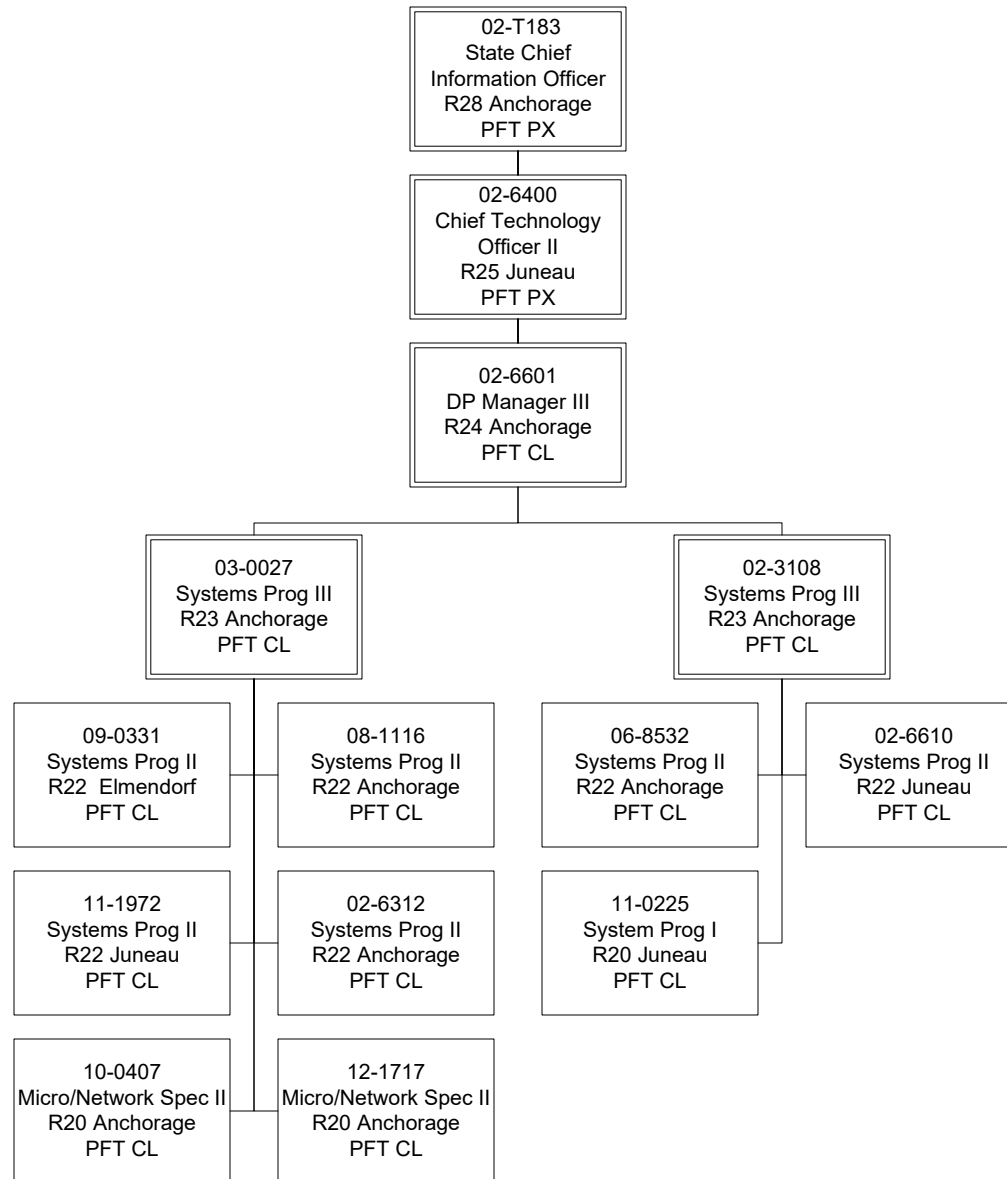

Department of Administration
Alaska Division of Information Technology (3141)
Platform Services – Database Services

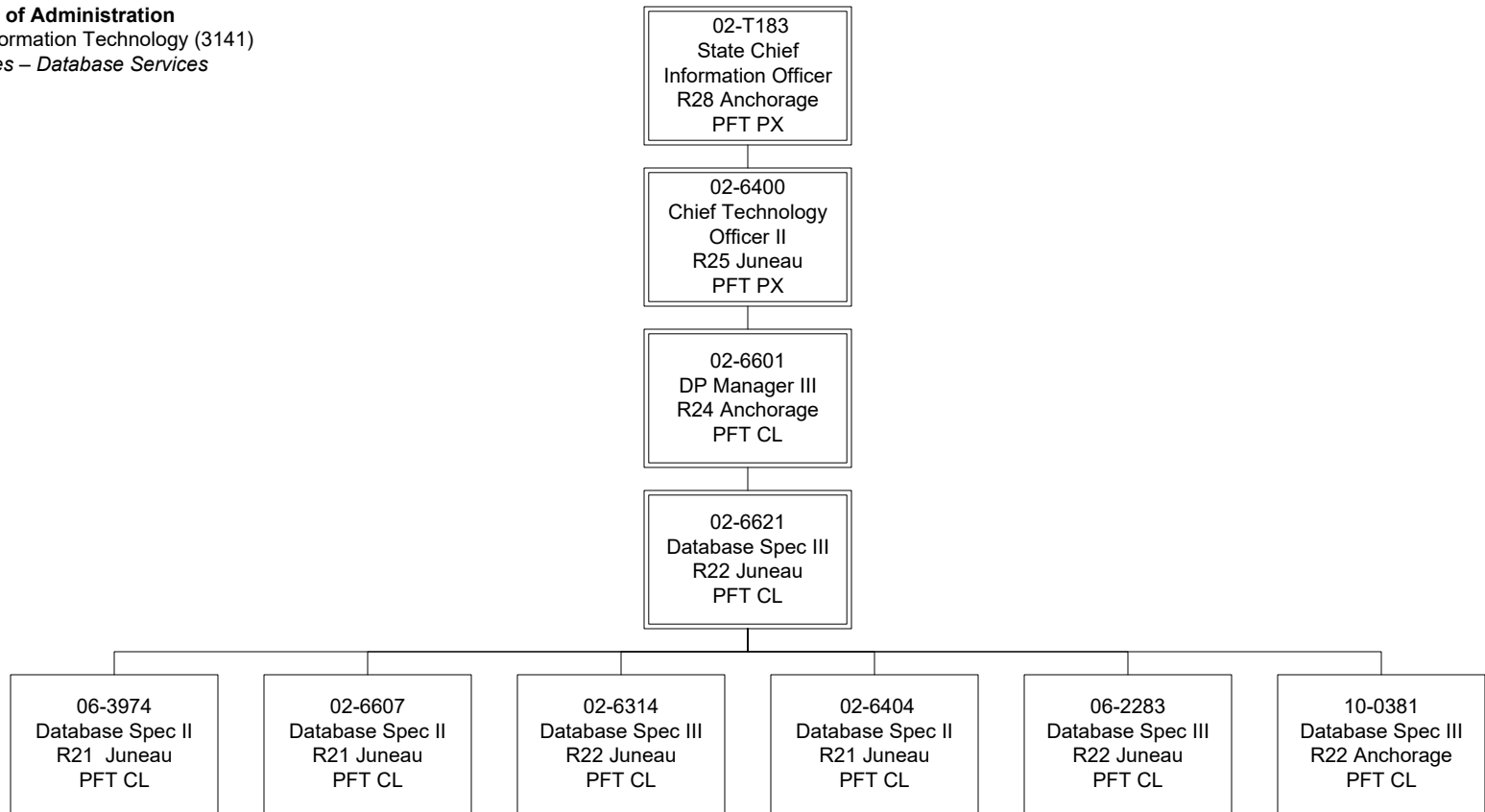

Department of Administration
 Alaska Division of Information Technology (3141)
Application Services

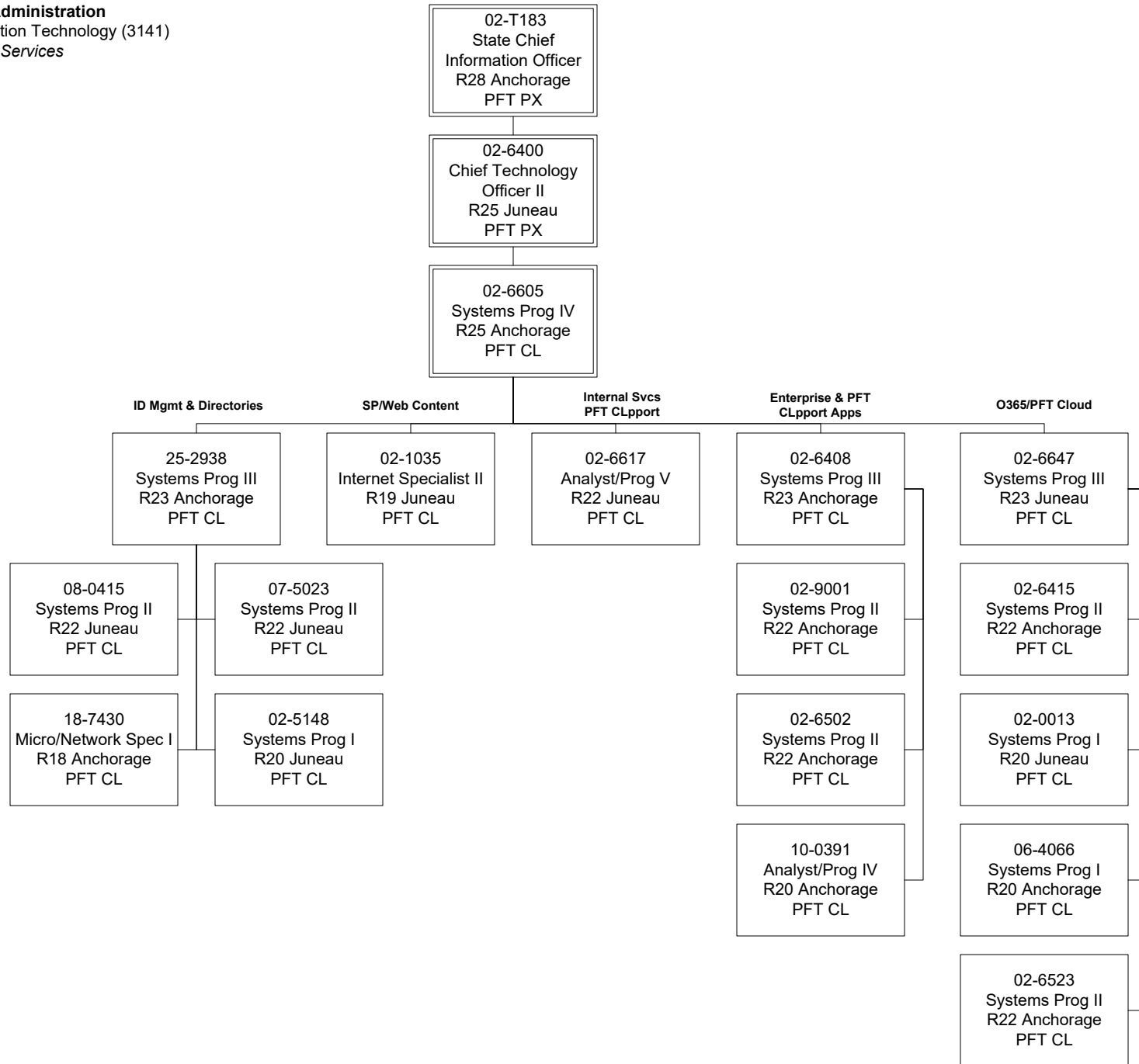

Department of Administration
Alaska Division of Information Technology (3141)
Mainframe Services

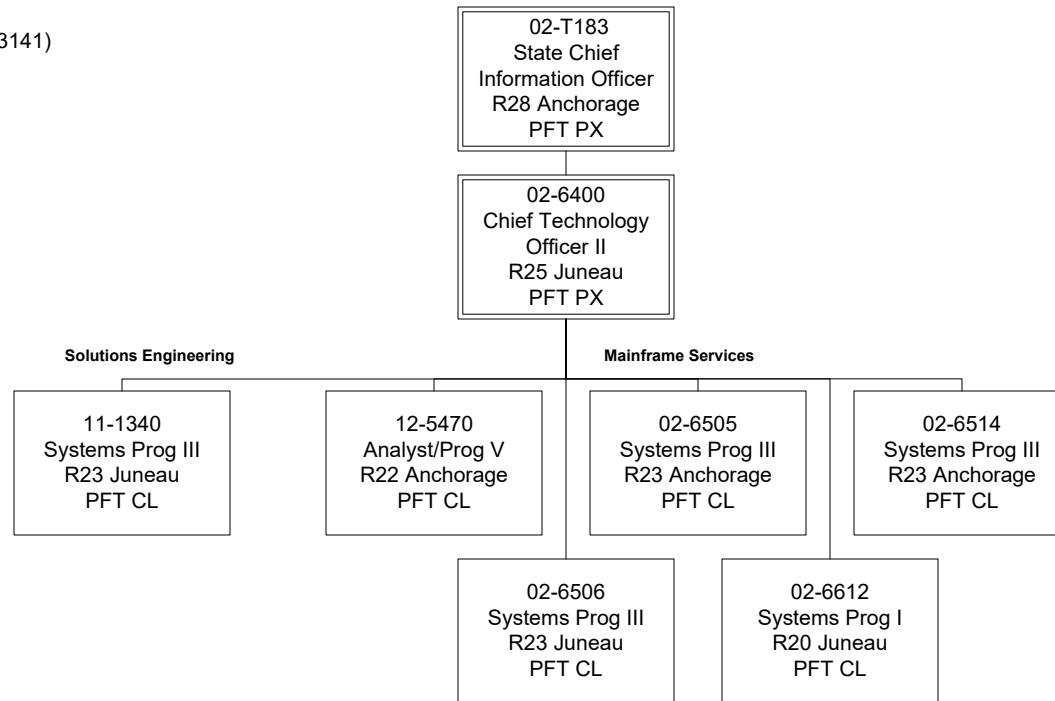

Department of Administration
 Alaska Division of Information Technology (3141)
Line of Business

