

Department of Administration
 Public Defender Agency (1631)
 RDU: Legal & Advocacy Services (11)
 FY2022 Governor's Budget
 Position Totals: 184 PFT | 1 PPT | 9 NP

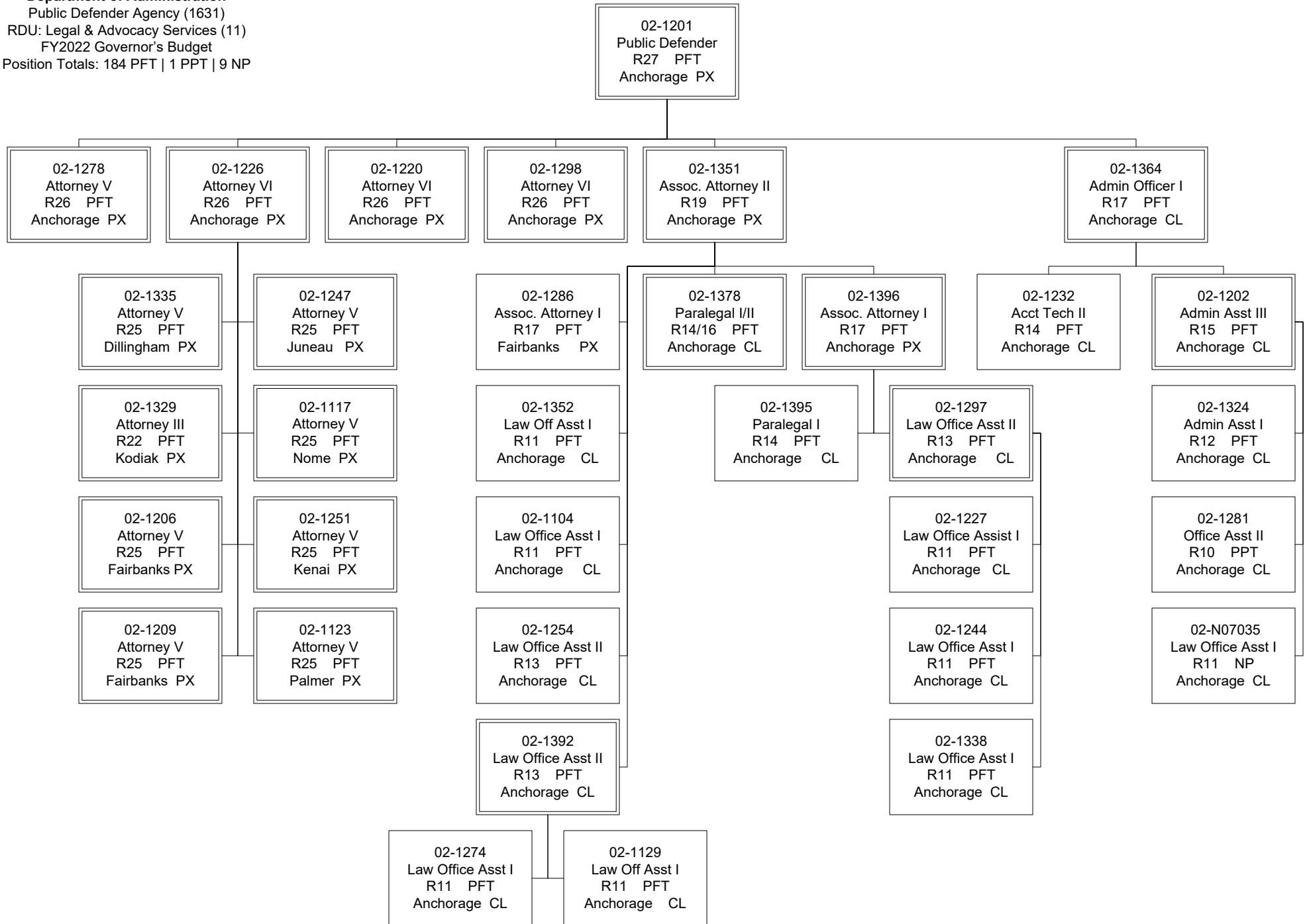

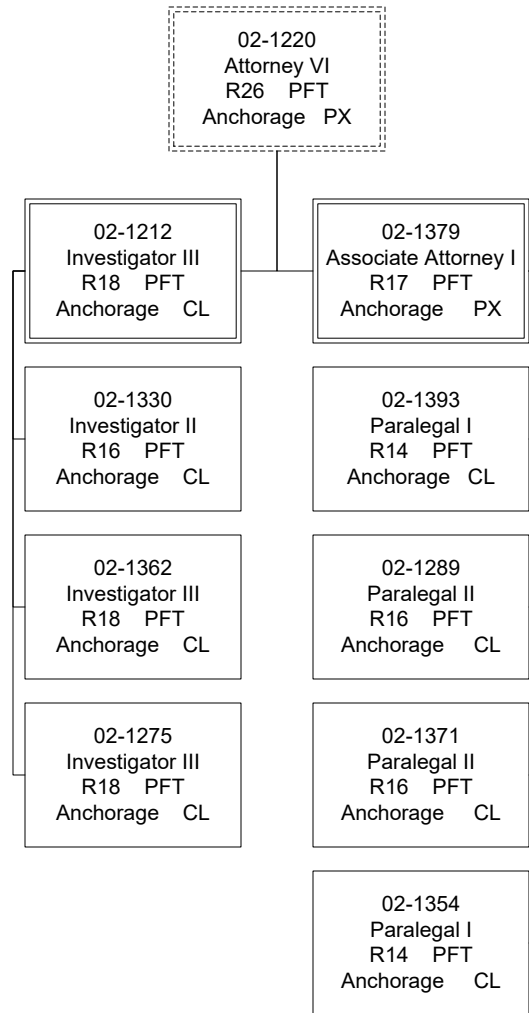

Department of Administration
 Public Defender Agency (1631)
 Anchorage Criminal Section

02-1220
 Attorney VI
 R26 PFT
 Anchorage PX

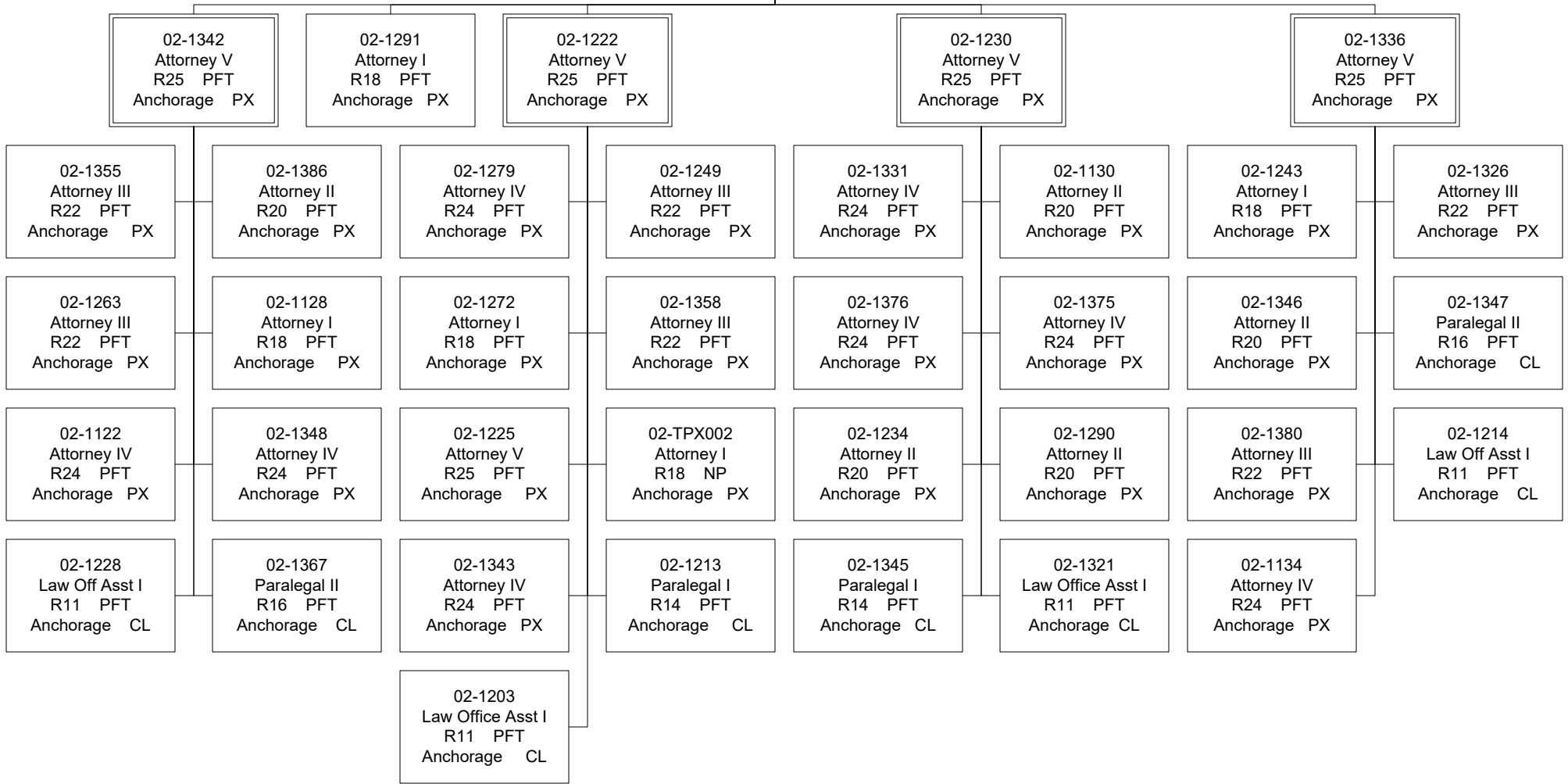

Department of Administration
Public Defender Agency (1631)
Appeals

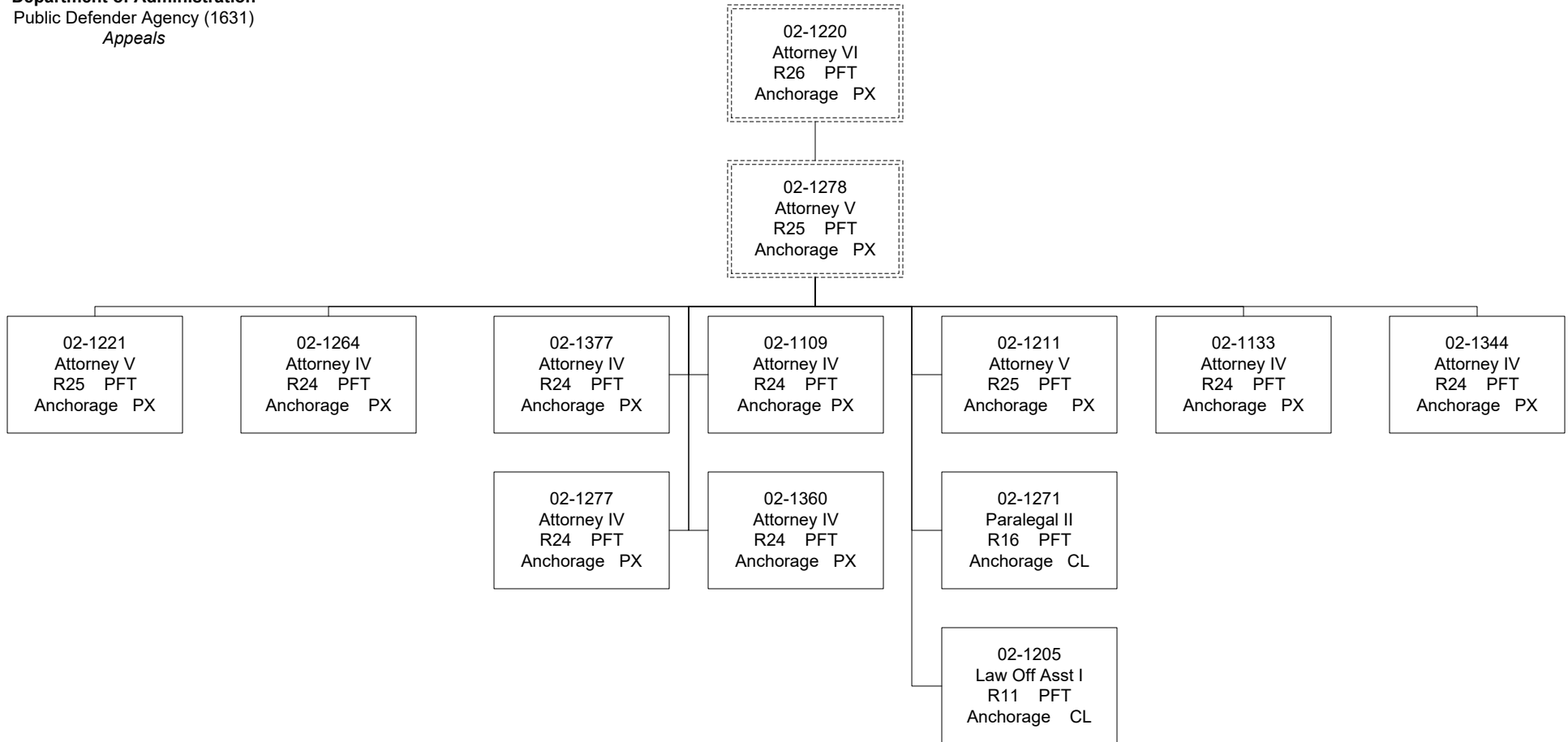

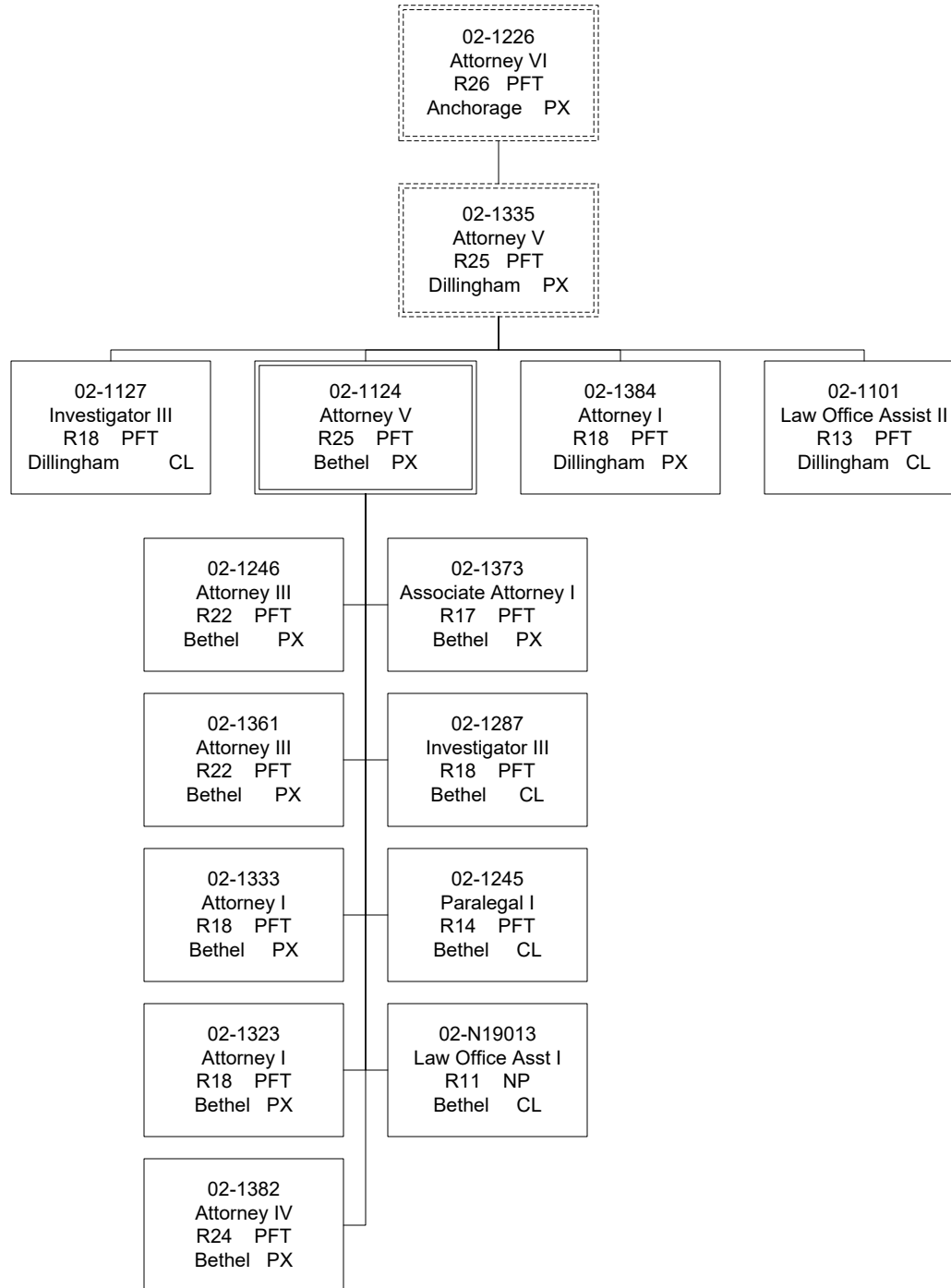

Department of Administration
Public Defender Agency (1631)
Civil Section

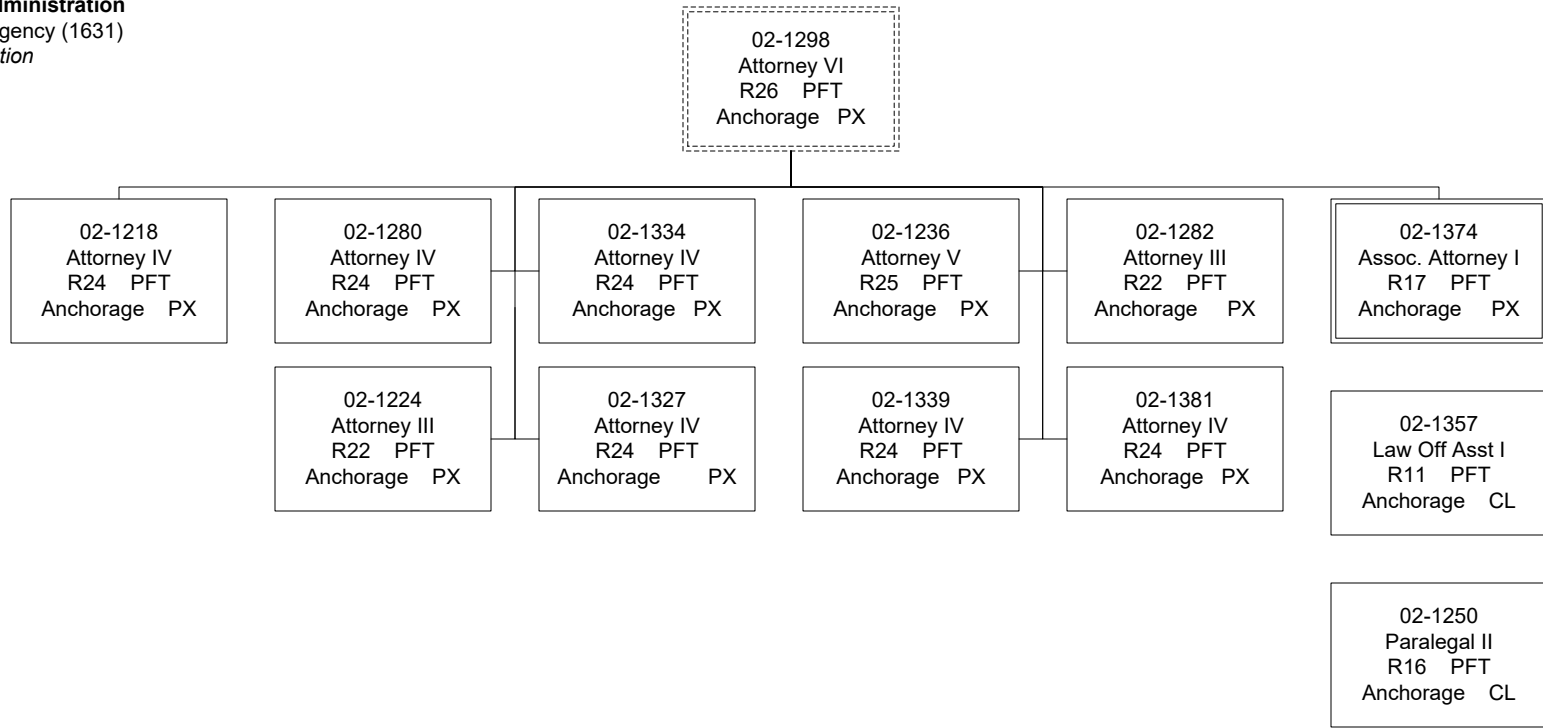

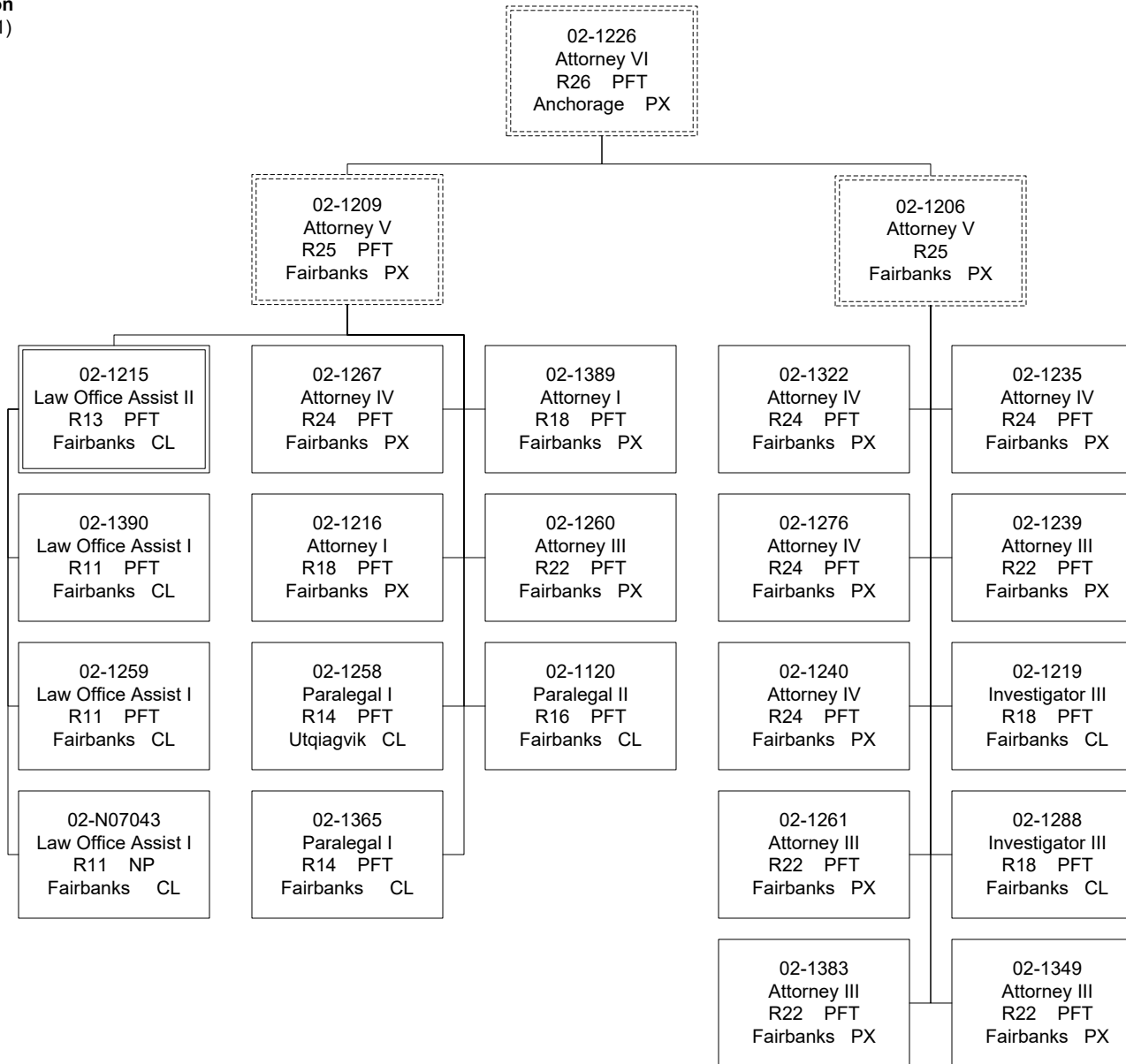

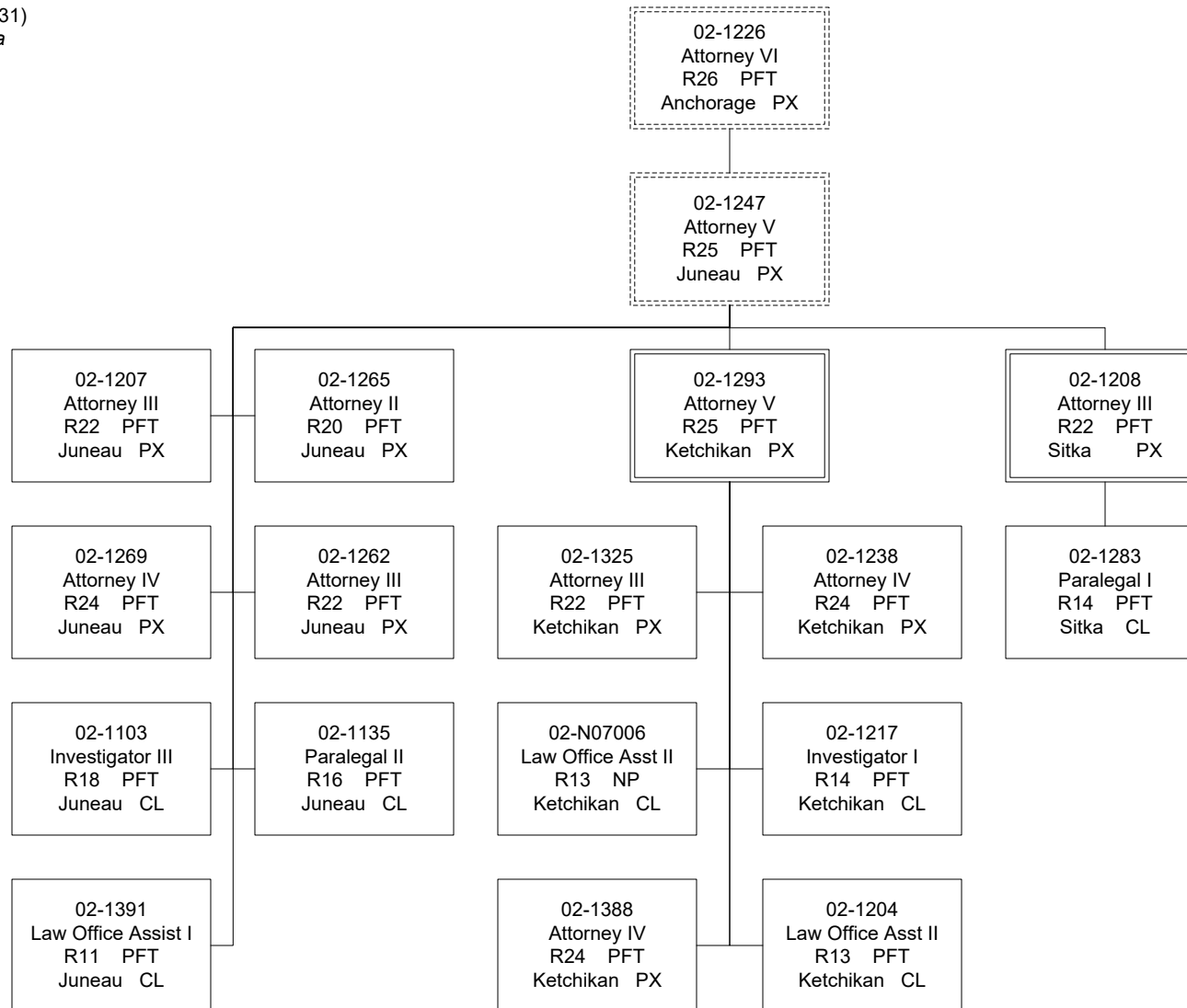

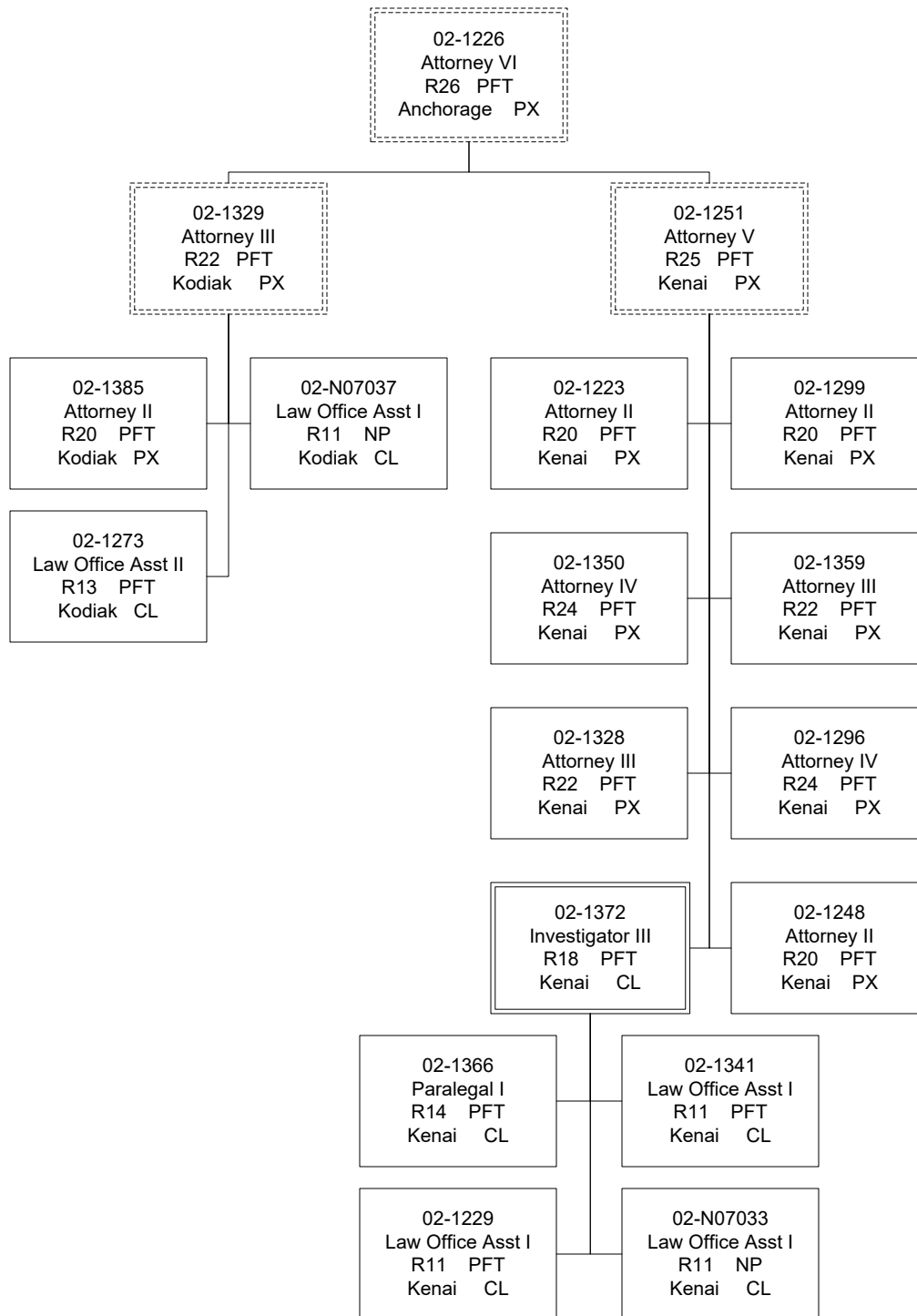

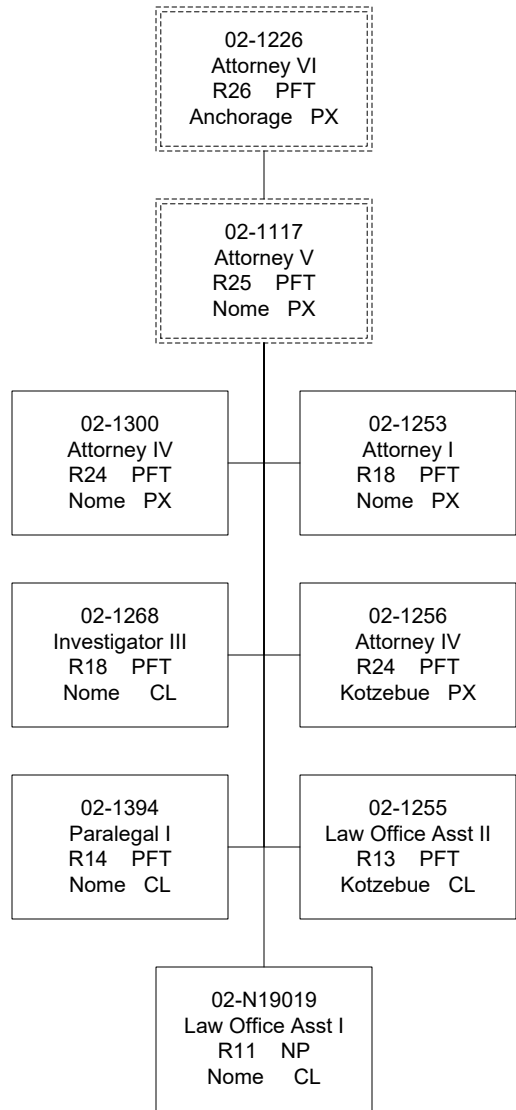

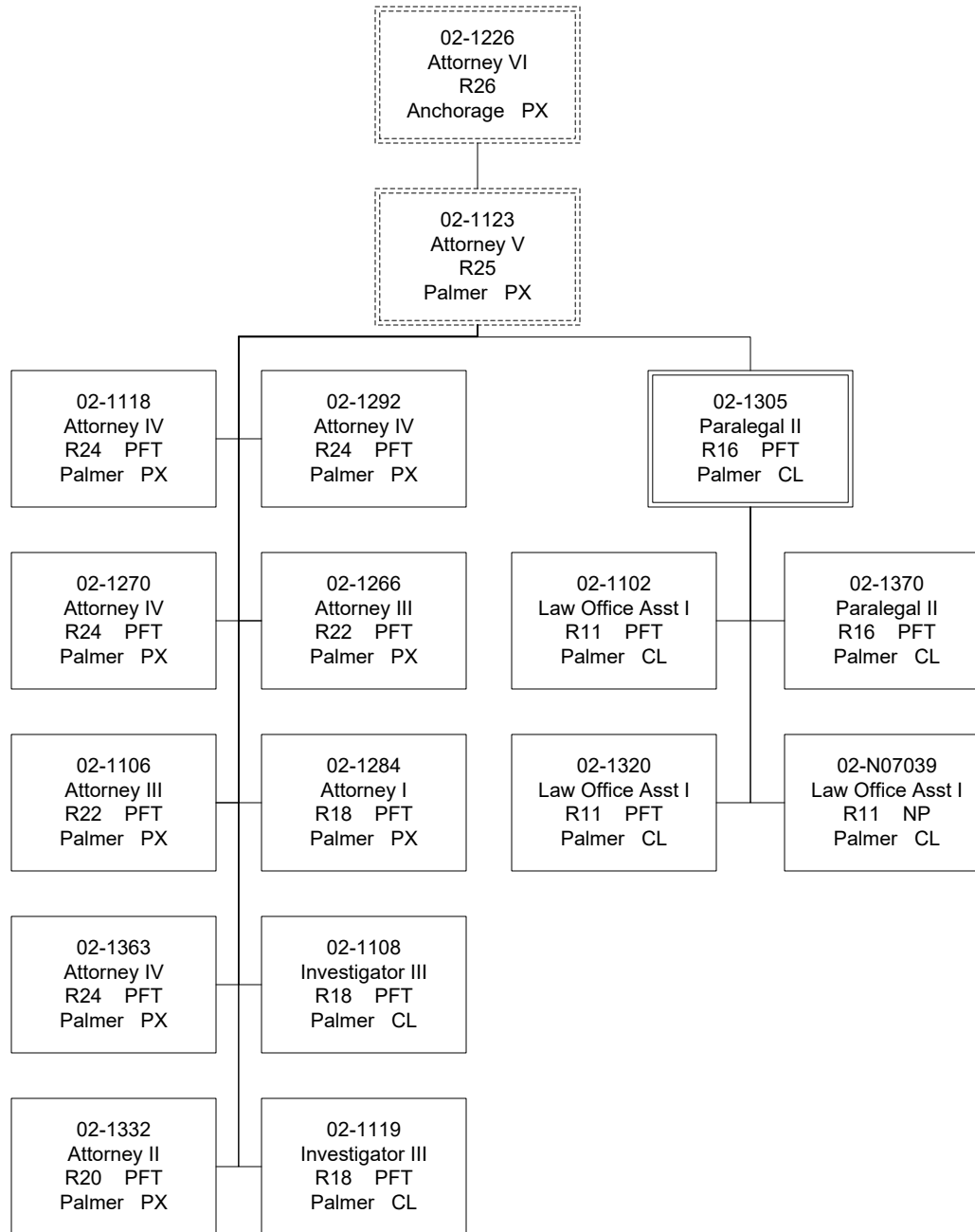

Department of Administration
Public Defender Agency (1631)
Traveling Section

