

Department of Administration
 Public Defender Agency (1631)
 RDU: Legal & Advocacy Services (11)
 FY2023 Governor's Budget
 Position Totals: 203 PFT | 1 PPT | 6 NP

02-1201
 Public Defender
 R27 PFT
 Anchorage PX

02-1226
 Attorney VI
 R26 PFT
 Anchorage PX

02-1220
 Attorney VI
 R26 PFT
 Anchorage PX

02-1298
 Attorney VI
 R26 PFT
 Anchorage PX

02-1278
 Attorney VI
 R26 PFT
 Anchorage PX

02-1378
 Program Manager
 R22 PFT
 Anchorage CL

02-1335
 Attorney V
 R25 PFT
 Dillingham PX

02-1247
 Attorney V
 R25 PFT
 Juneau PX

02-1400
 Law Office Asst II
 R13 PFT
 Anchorage CL

02-1392
 Law Office Asst II
 R13 PFT
 Anchorage CL

02-1254
 Paralegal I
 R14 PFT
 Anchorage CL

02-1396
 Assoc. Attorney I
 R17 PFT
 Anchorage PX

02-1202
 Admin Asst III
 R15 PFT
 Anchorage CL

02-1364
 Admin Officer I
 R17 PFT
 Anchorage CL

02-1329
 Attorney IV
 R24 PFT
 Anchorage PX

02-1117
 Attorney V
 R25 PFT
 Nome PX

02-1274
 Law Office Asst I
 R11 PFT
 Anchorage CL

02-1286
 Assoc. Attorney I
 R17 PFT
 Fairbanks PX

02-1244
 Law Office Asst I
 R11 PFT
 Anchorage CL

02-1297
 Law Office Asst II
 R13 PFT
 Anchorage CL

02-1232
 Acct Tech II
 R14 PFT
 Anchorage CL

02-1281
 Office Asst II
 R10 PPT
 Anchorage CL

02-1206
 Attorney V
 R25 PFT
 Fairbanks PX

02-1251
 Attorney V
 R25 PFT
 Kenai PX

02-1129
 Law Off Asst I
 R11 PFT
 Anchorage CL

02-1227
 Law Office Assist I
 R11 PFT
 Anchorage CL

02-1352
 Law Off Asst I
 R11 PFT
 Anchorage CL

02-1209
 Attorney V
 R25 PFT
 Fairbanks PX

02-1123
 Attorney V
 R25 PFT
 Palmer PX

02-1401
 Paralegal I
 R14 PFT
 Anchorage CL

02-1203
 Law Office Asst I
 R11 PFT
 Anchorage CL

02-1398
 Law Off Asst I
 R11 PFT
 Anchorage CL

02-N07035
 Law Office Assist I
 R11 NP
 Anchorage CL

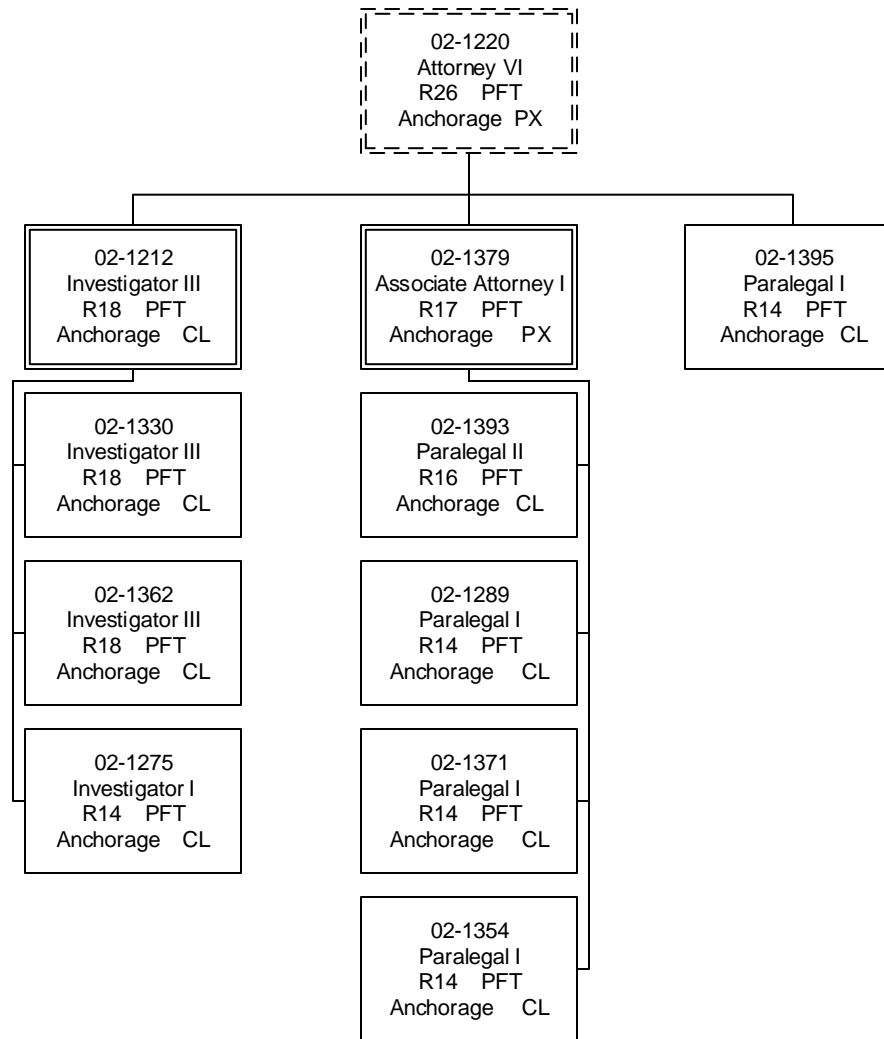

Department of Administration
 Public Defender Agency (1631)
 Anchorage Criminal Section

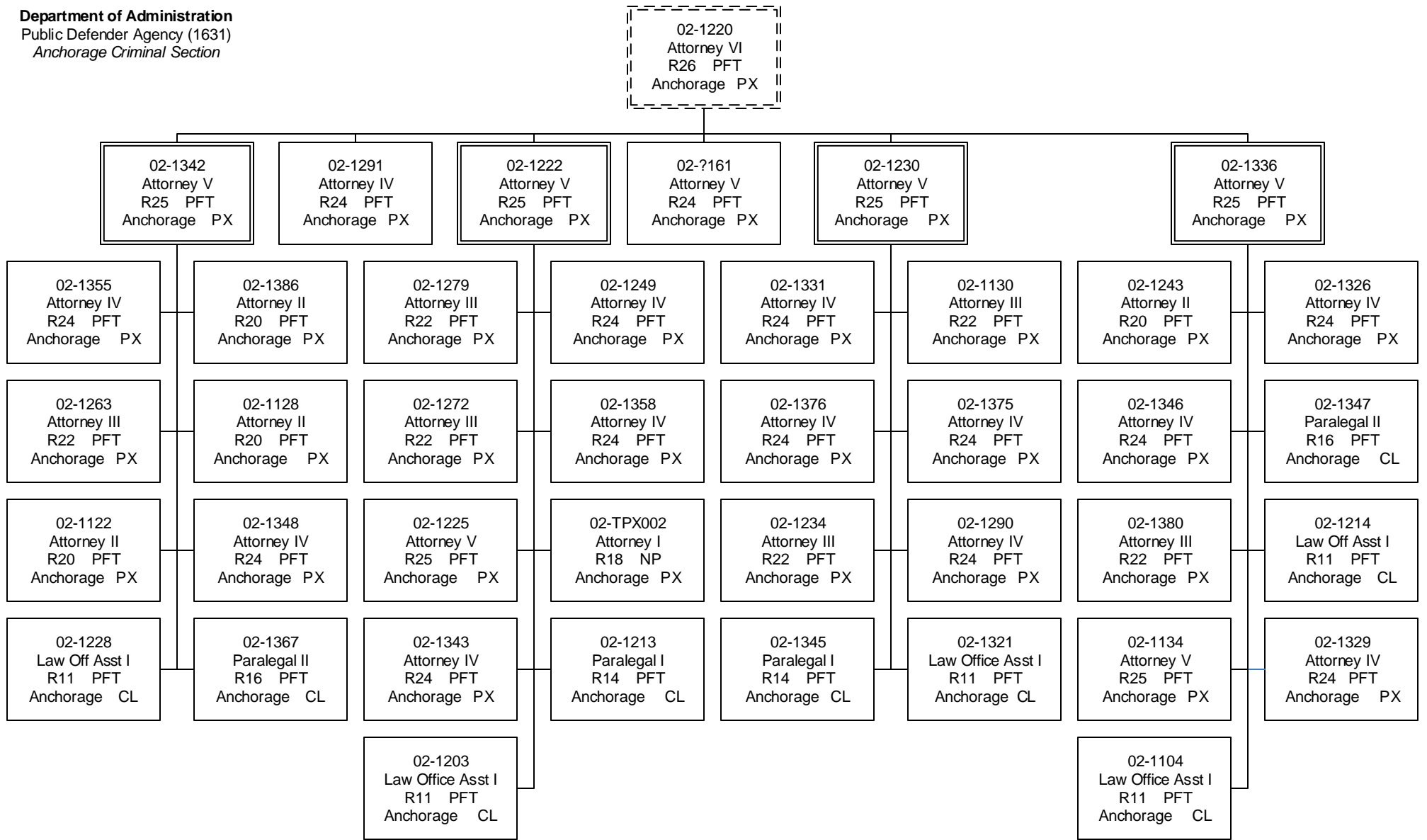

Department of Administration
Public Defender Agency (1631)
Appeals

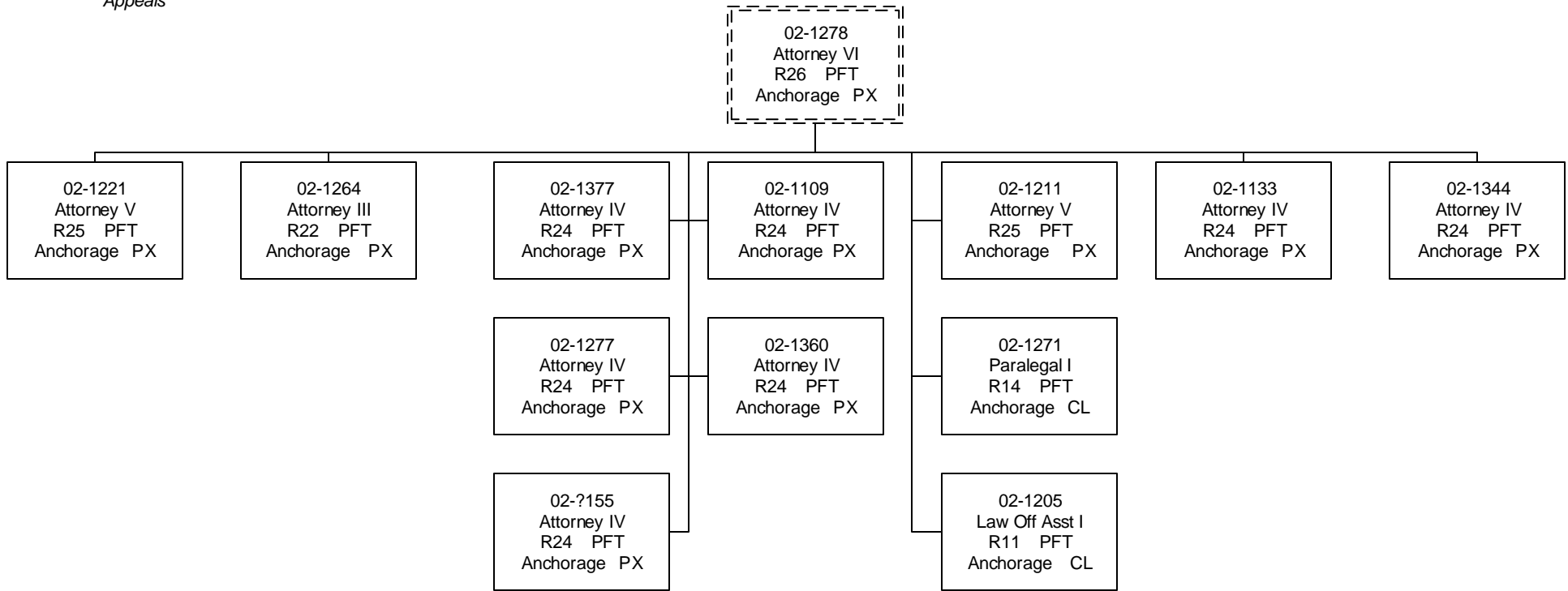

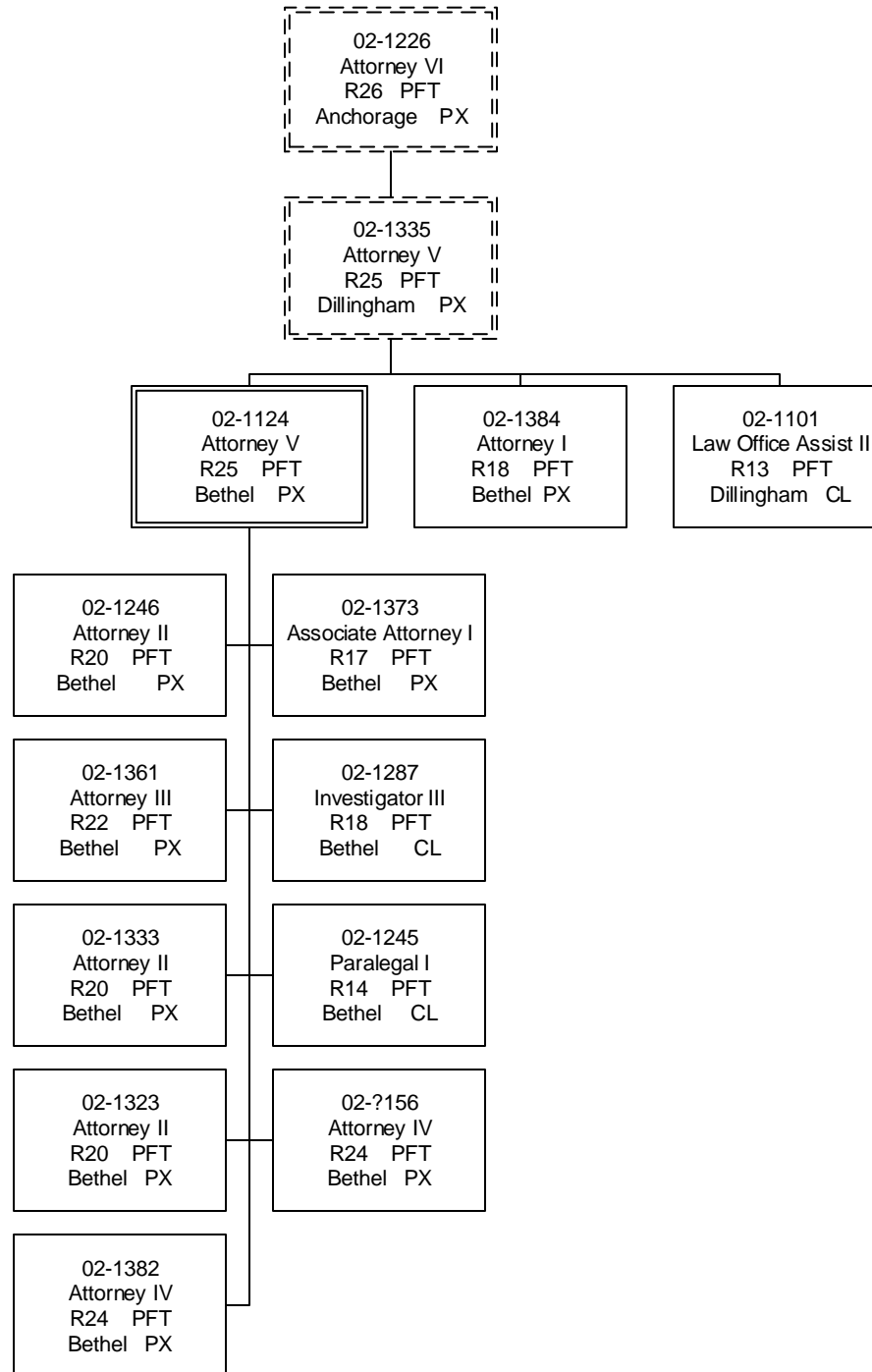

Department of Administration
Public Defender Agency (1631)
Civil Section

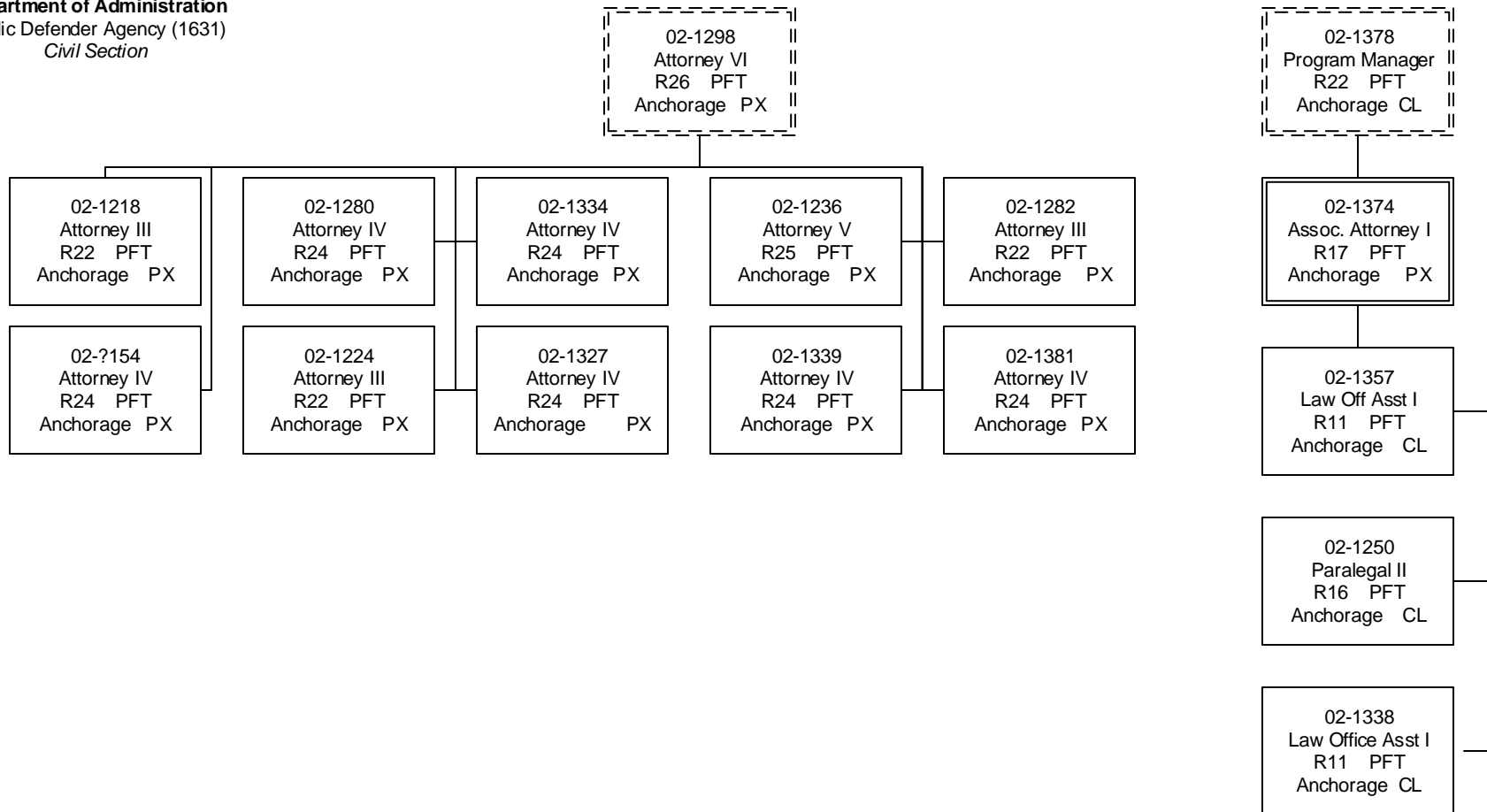

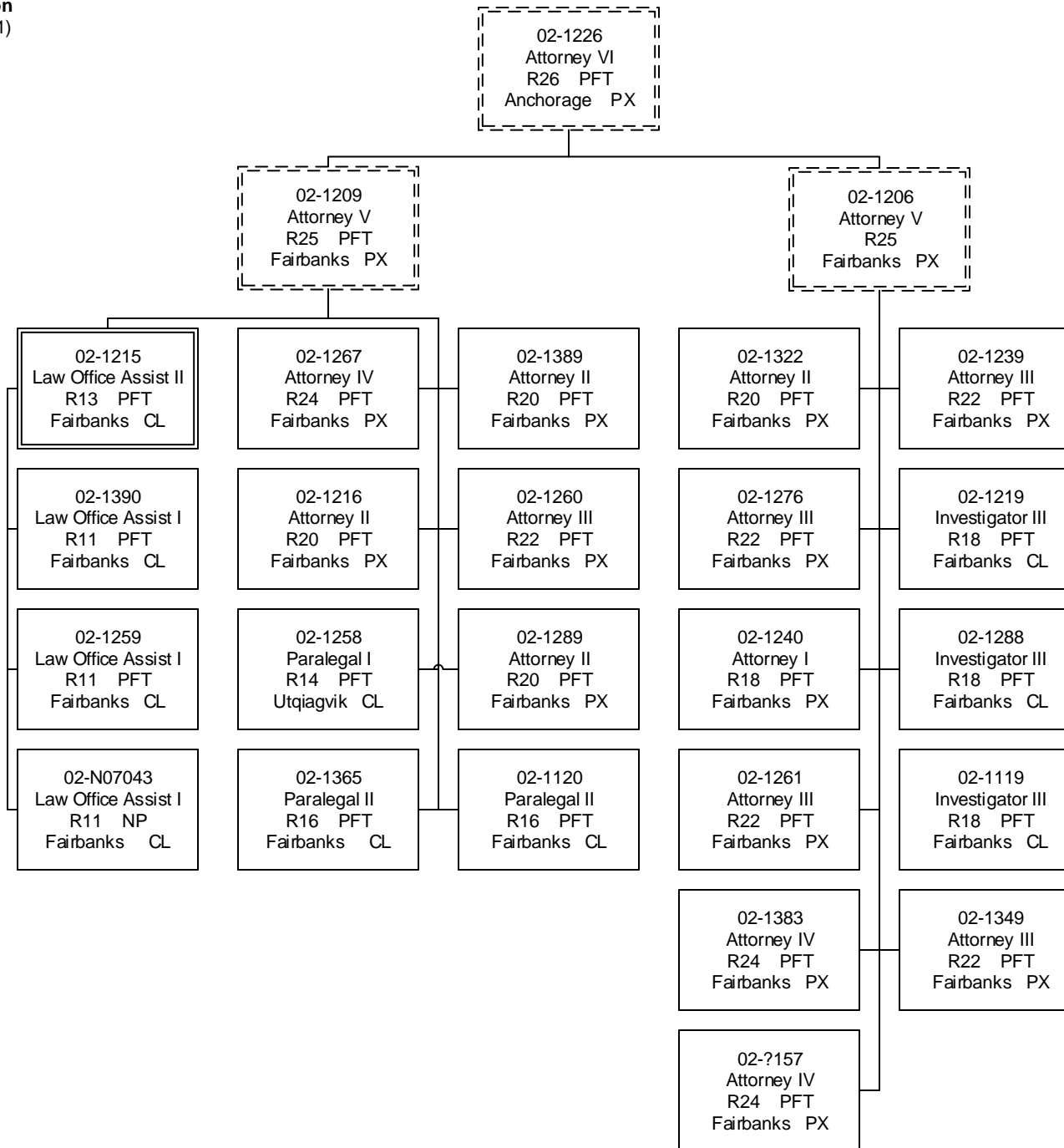

Department of Administration
Public Defender Agency (1631)
Juneau, Ketchikan & Sitka

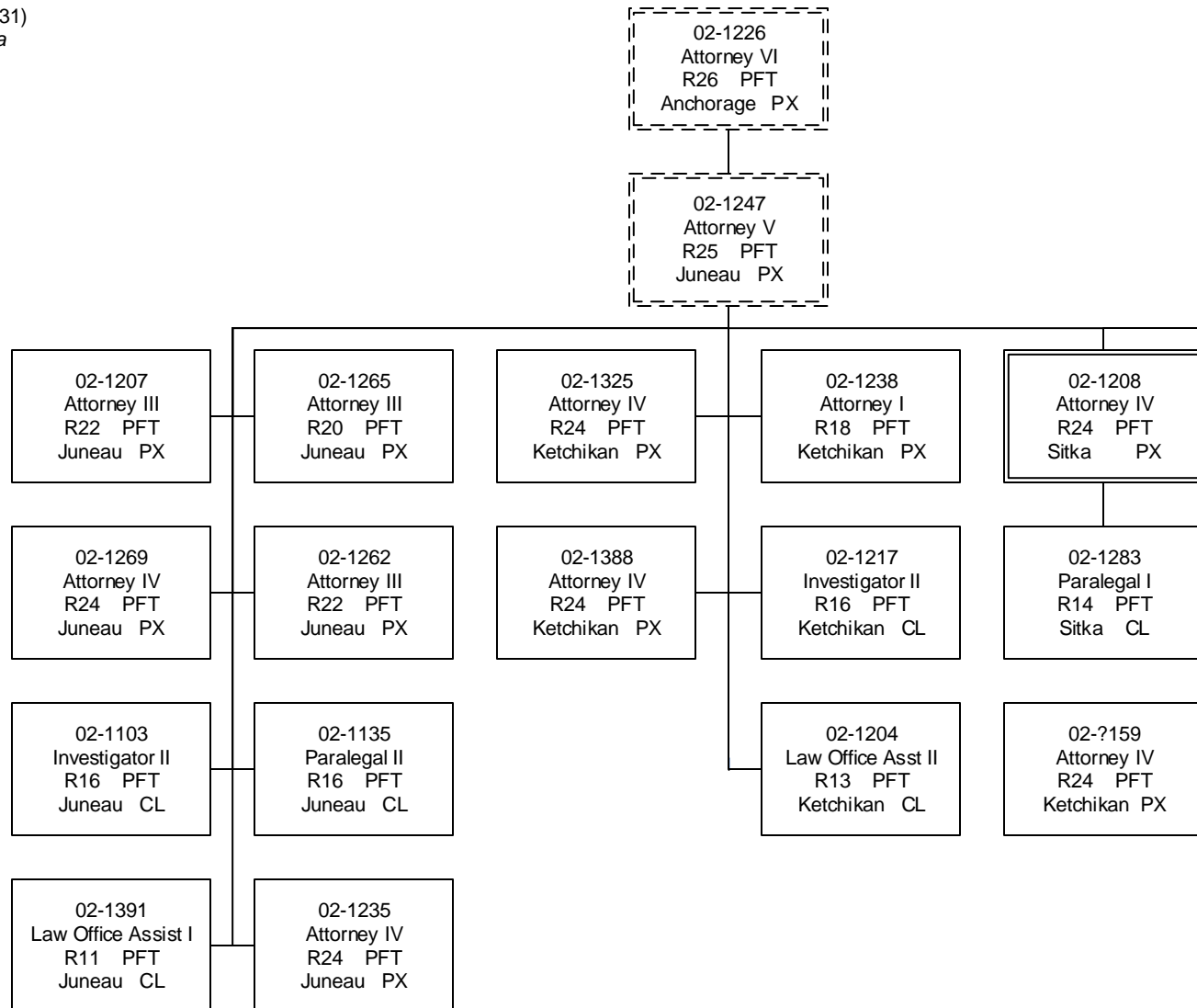

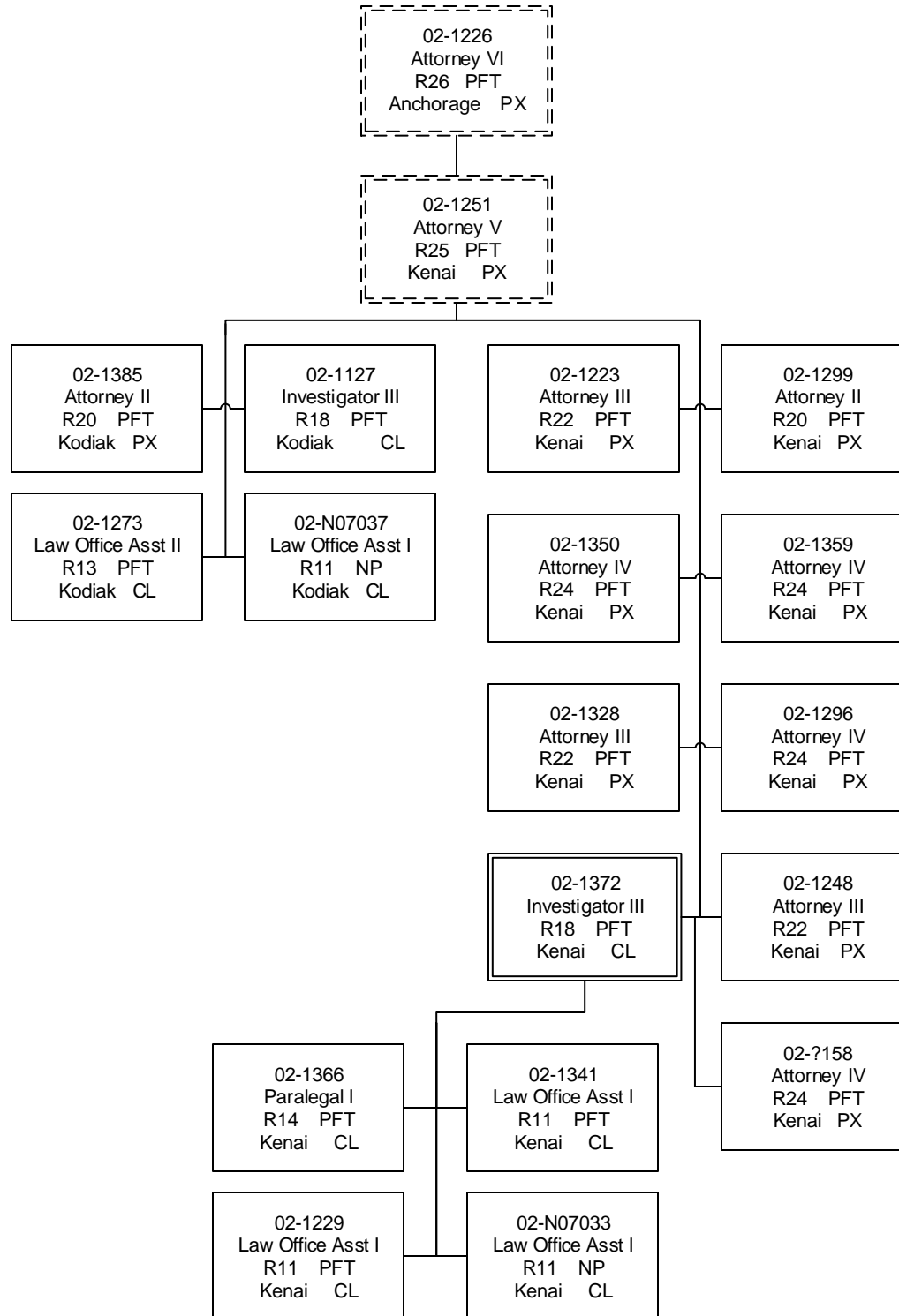

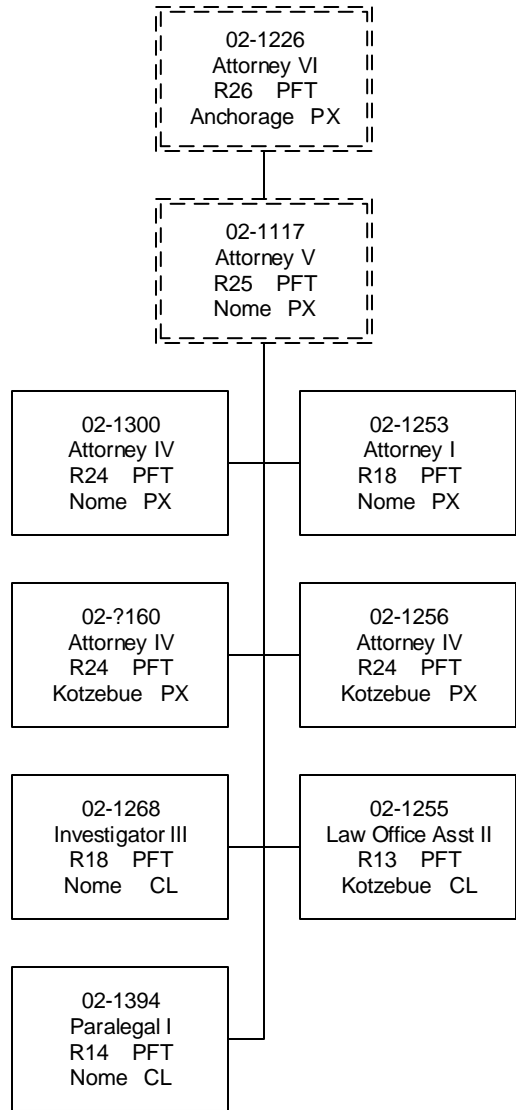

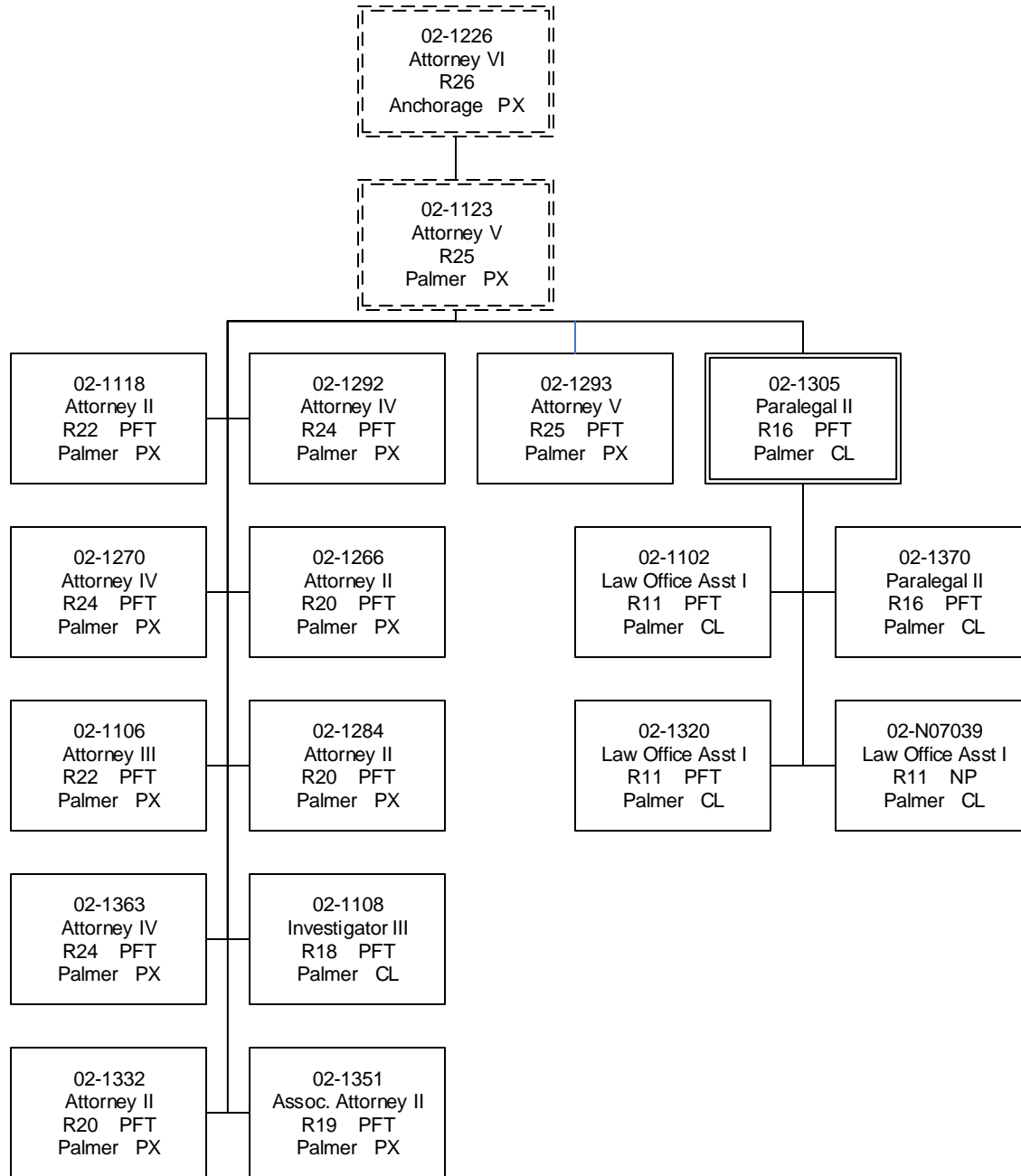

Department of Administration
Public Defender Agency (1631)
Traveling Section

