

Department of Administration
Finance (59) & E-Travel (2966)
RDU: Centralized Admin Services (13)
Position Totals PFT – 126 PPT - 1

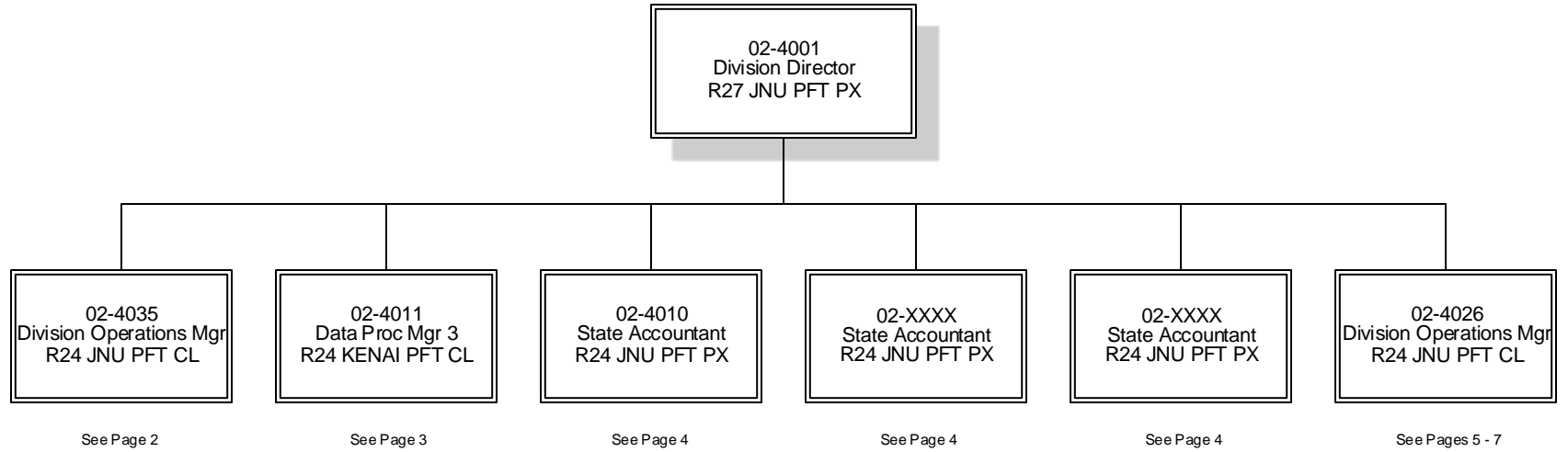

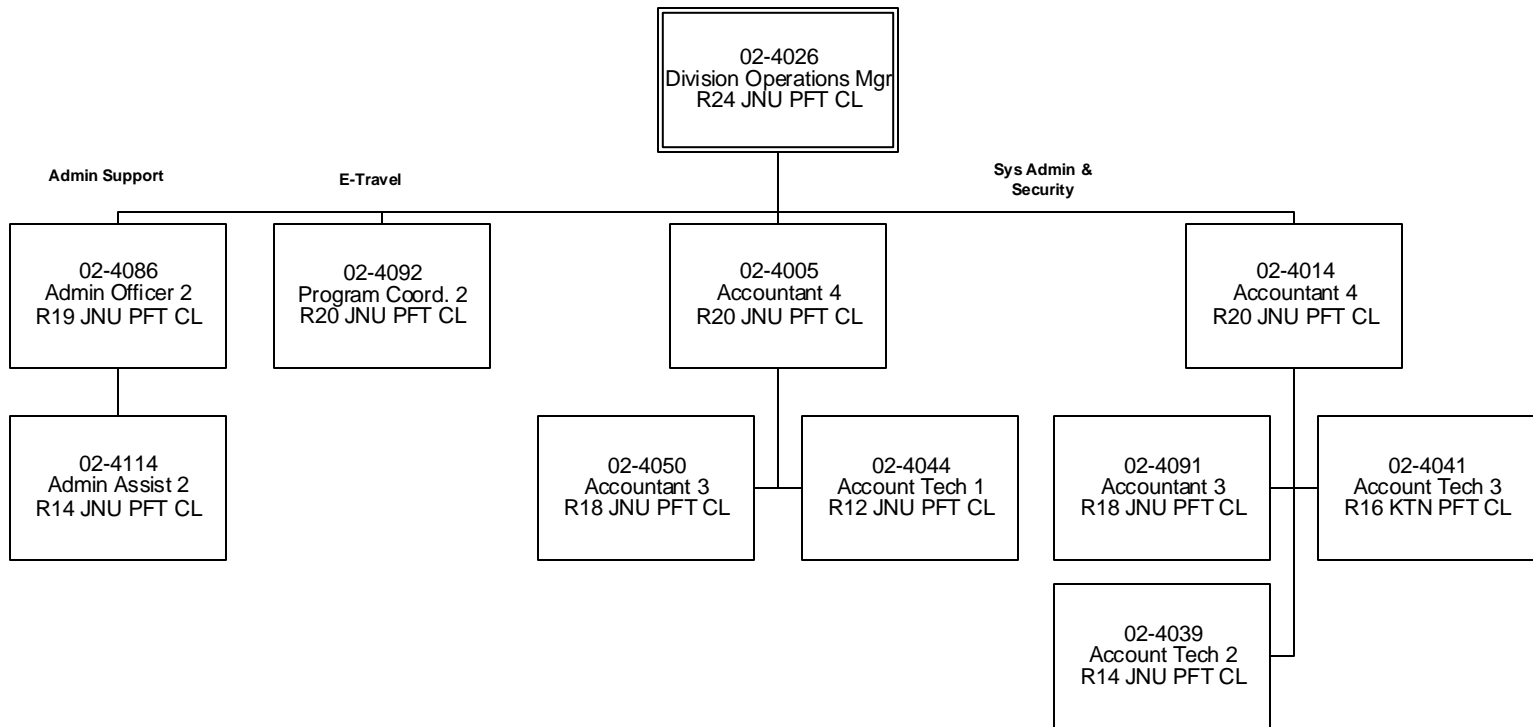

02-4011
Data Processing Mgr 3
R24 KENAI PFT CL

IT Support

IRIS FIN/PROC

IRIS HRM/Payroll

02-4116
Pub Spec 3
R19 JNU PFT CL

02-4082
Analyst/Prog 5
R22 JNU PFT CL

02-4075
Accountant 5
R22 JNU PFT CL

02-4101
Bus Analyst 3
R22 JNU PFT CL

02-4078
Analyst/Prog 5
R22 JNU PFT CL

02-4081
Analyst/Prog 3
R18 JNU PFT CL

02-4027
Bus Analyst 2
R20 JNU PFT CL

02-1007
Bus Analyst 2
R20 JNU PFT CL

02-2133
Database Spec 2
R21 JNU PFT CL

02-4030
Business Analyst 2
R20 JNU PFT CL

02-4115
Bus Analyst 2
R20 JNU PFT CL

02-4117
Bus Analyst 2
R20 JNU PFT CL

02-4111
Analyst/Prog 4
R20 JNU PFT CL

02-4074
Analyst/Prog 2
R16 ANC PFT CL

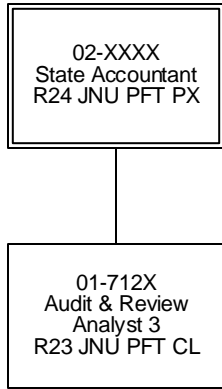

**Statewide Single
Audit**

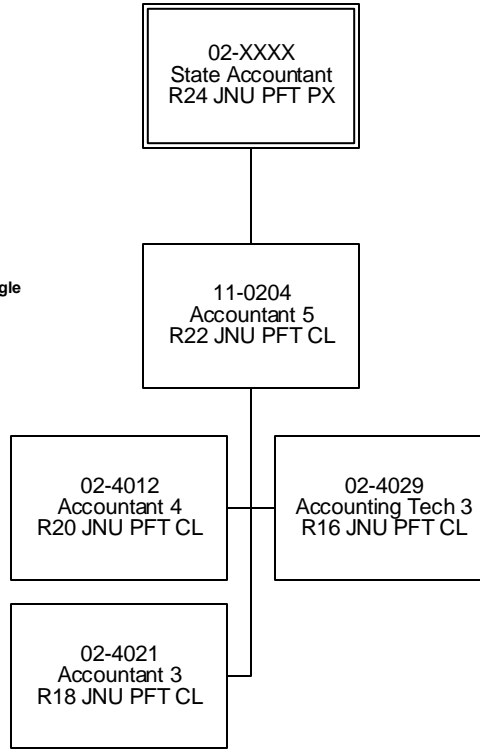

**Accounting &
Warrant Services**

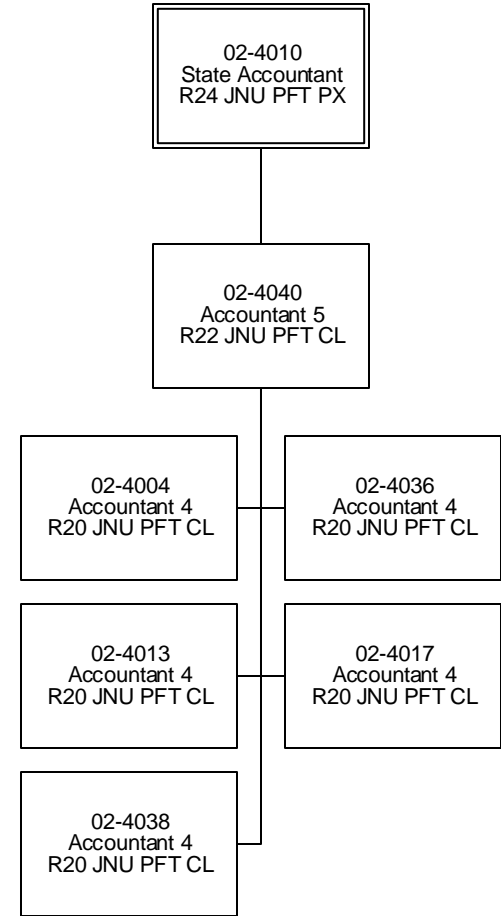

State Payroll Services

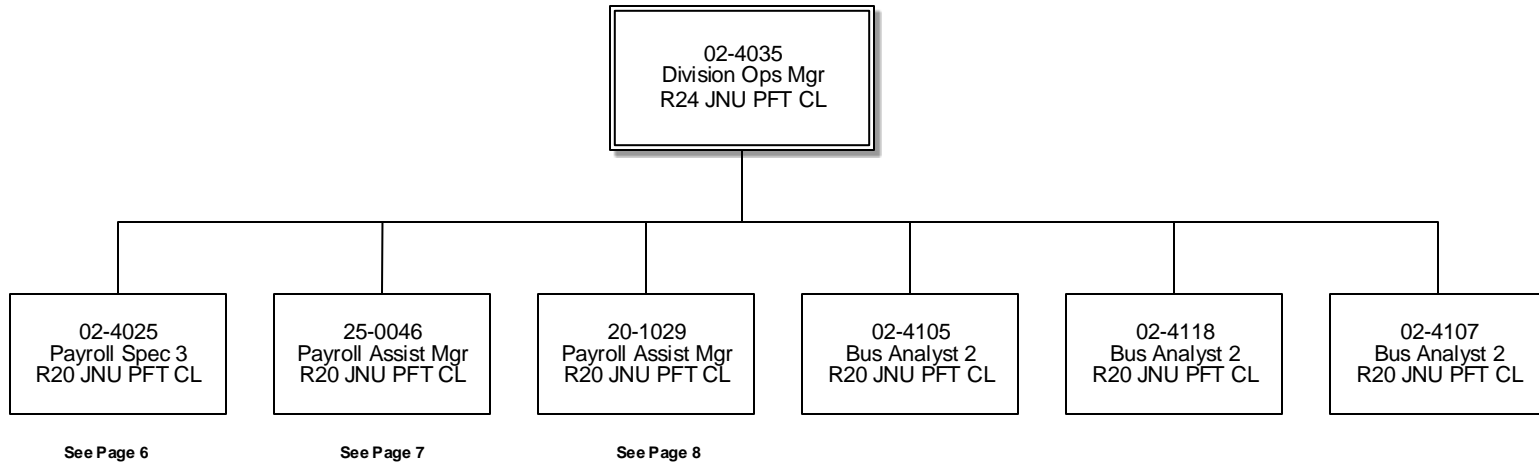

Payroll Production Services

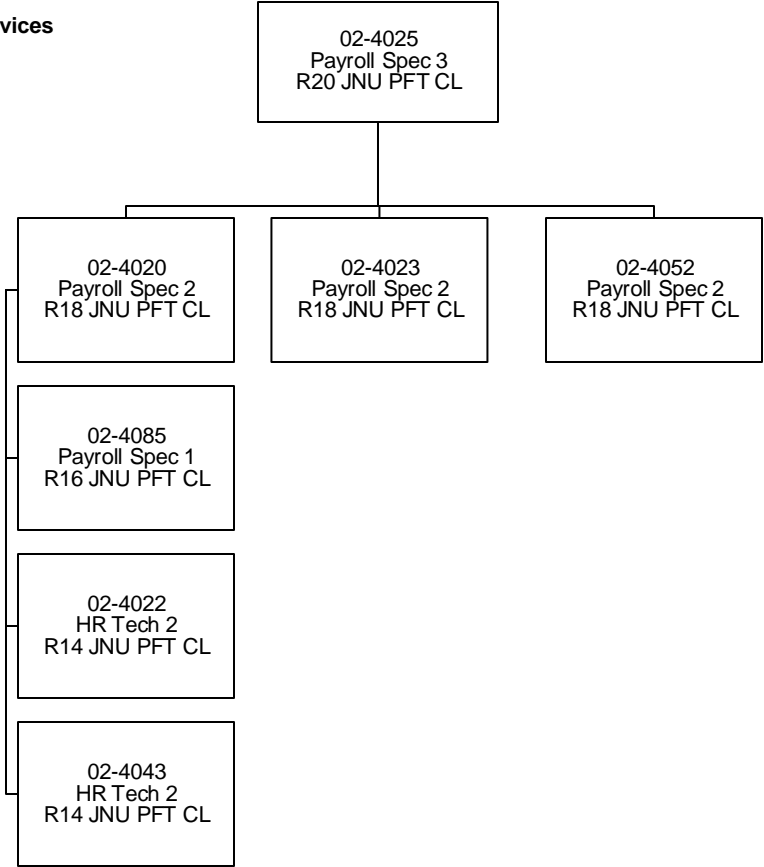

Payroll Services – ADOT&PF / H&SS Sections

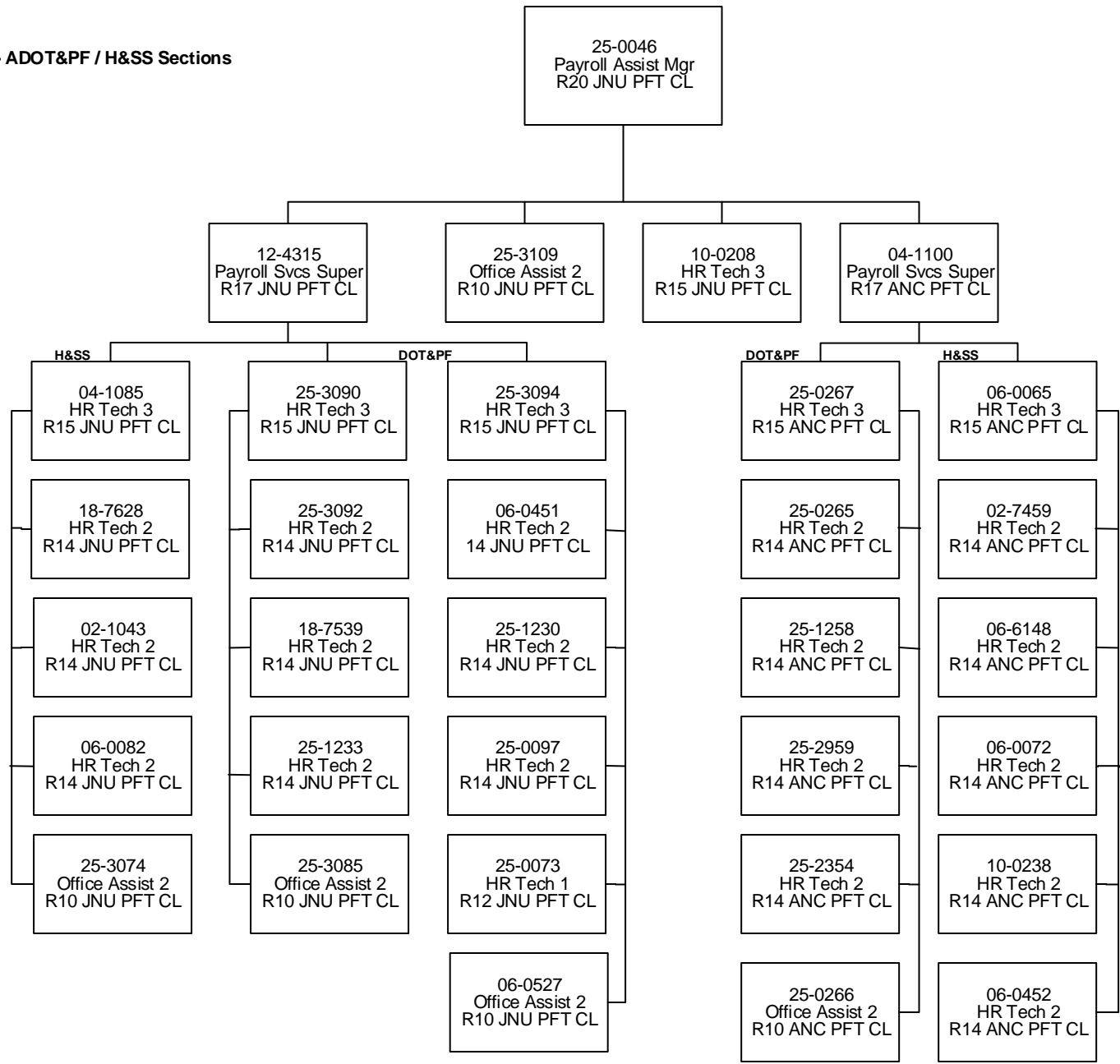

Payroll Services - Gen Agency/Public Protect/Resources Sections

