

BOX TYPES
Commercial Fisheries
D - Duplicate

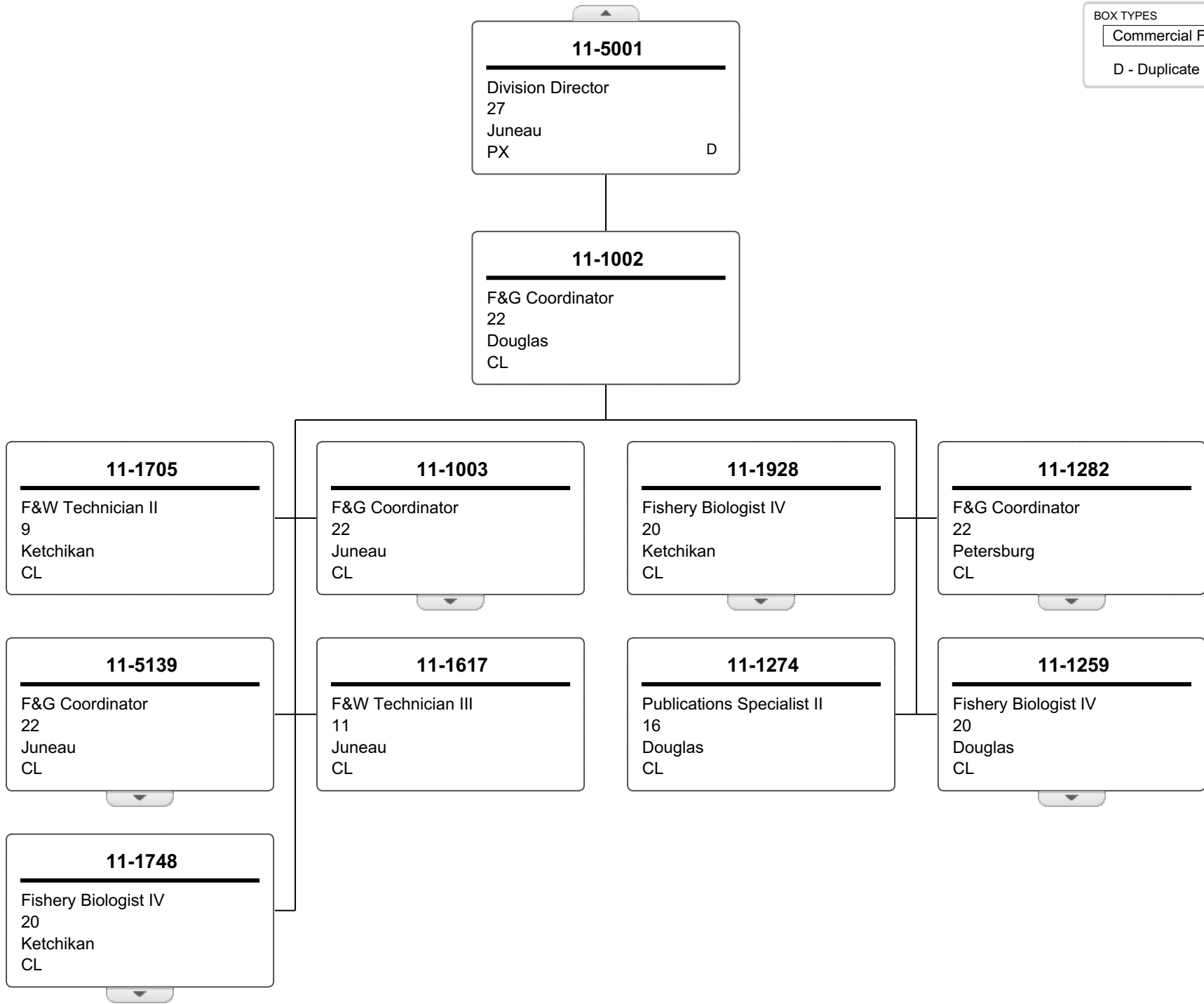

BOX TYPES
 Commercial Fisheries
 D - Duplicate

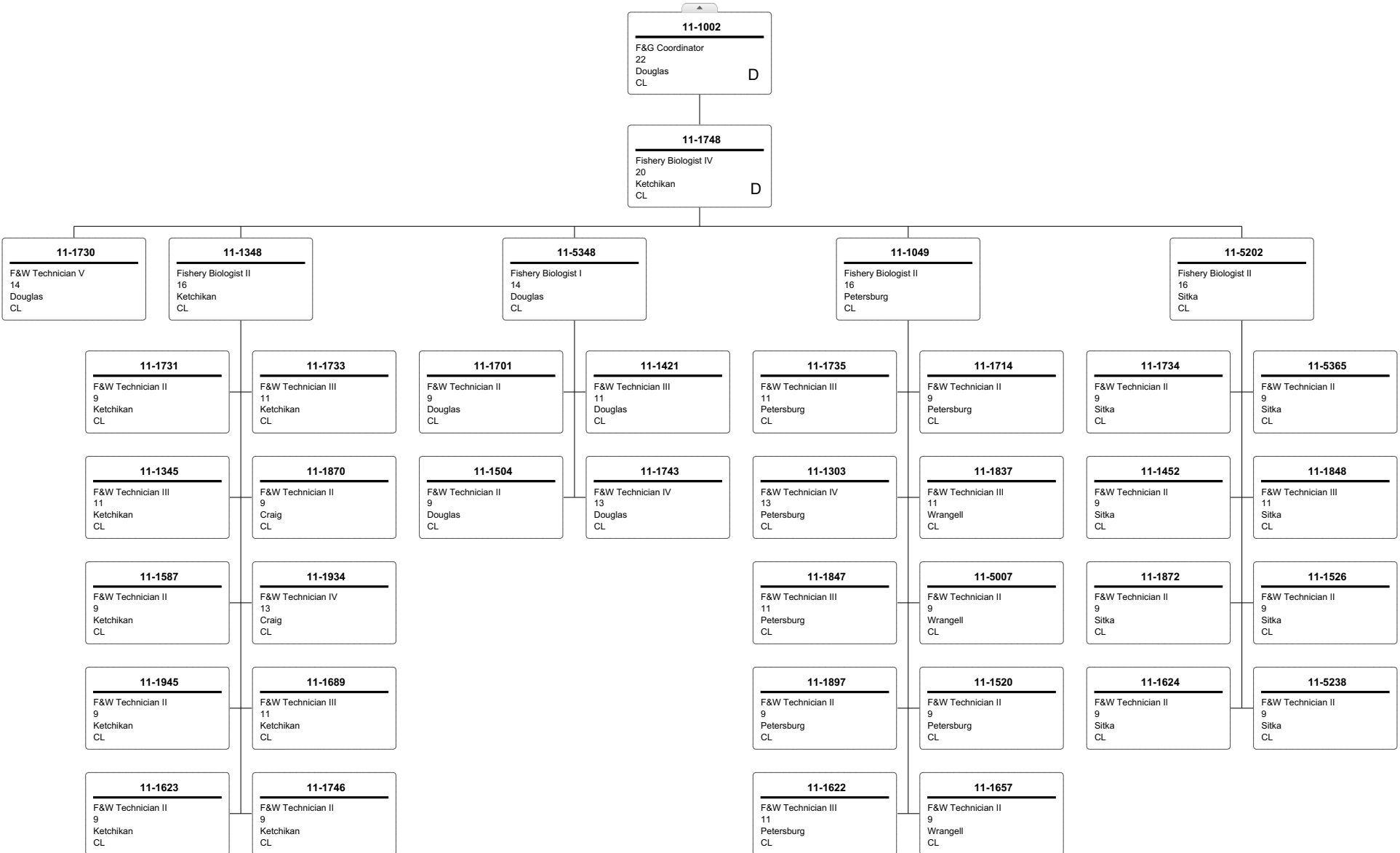

BOX TYPES
 Commercial Fisheries
 D - Duplicate

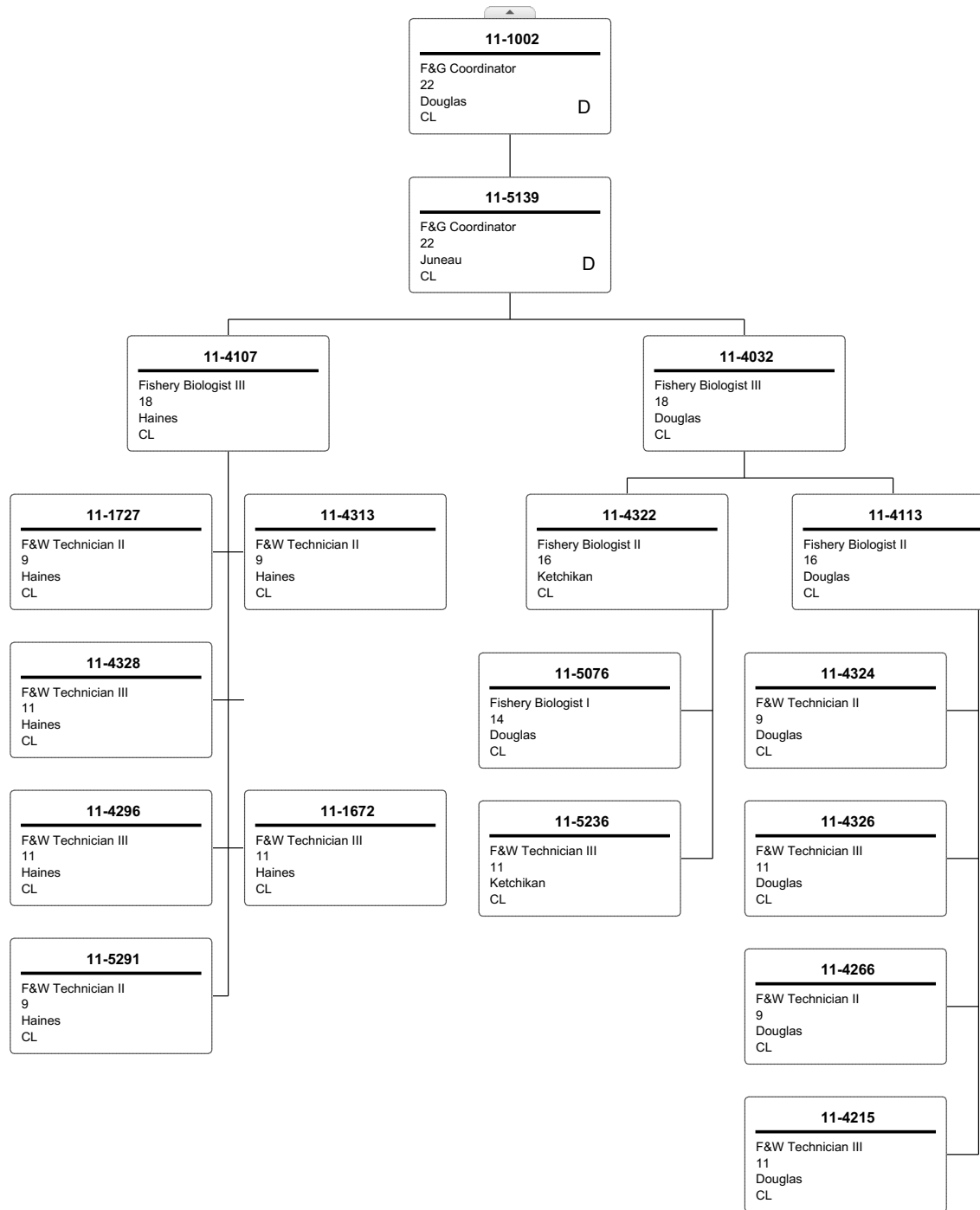

BOX TYPES
Commercial Fisheries
D - Duplicate

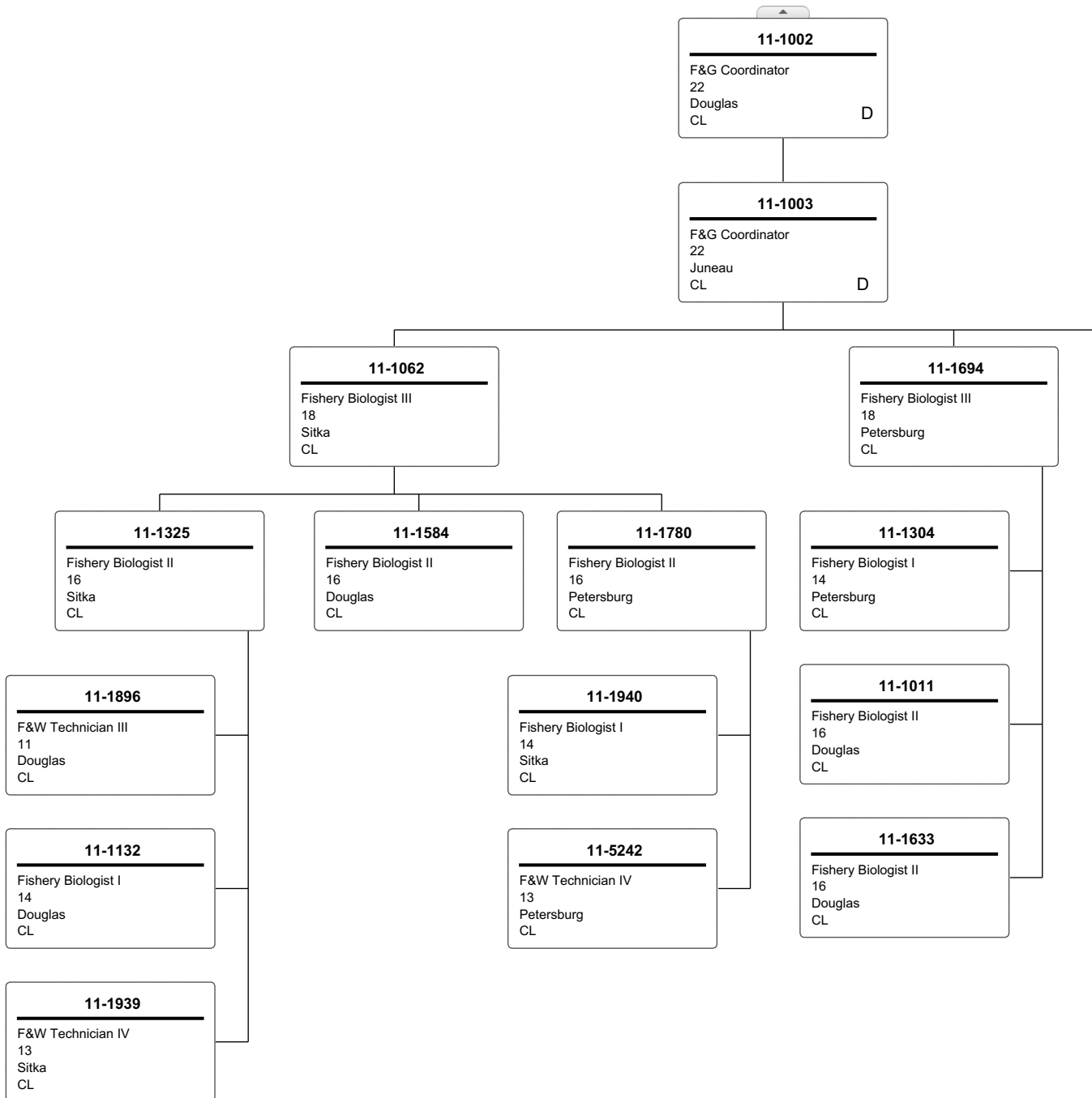

BOX TYPES
 Commercial Fisheries
 D - Duplicate

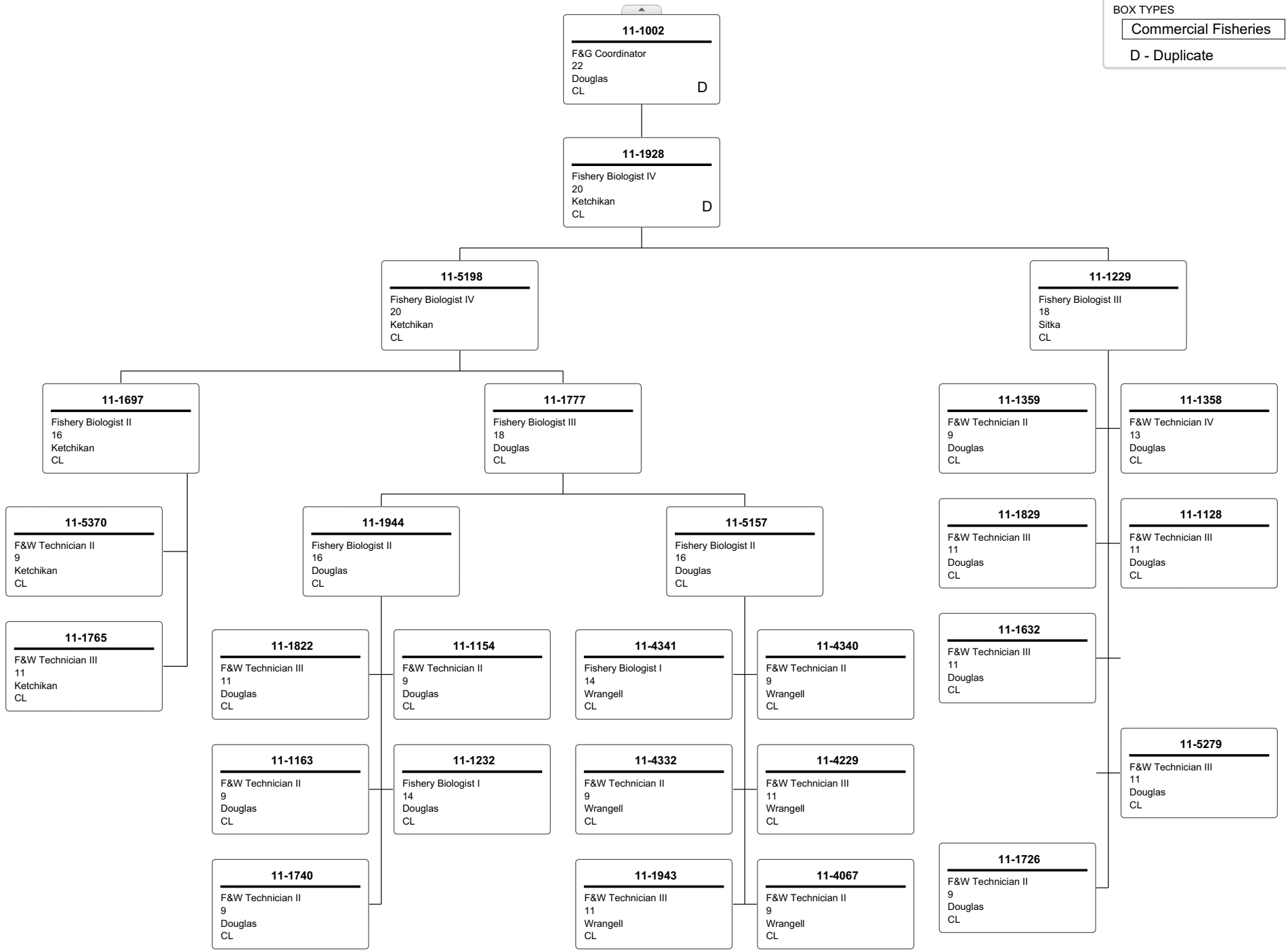

BOX TYPES
Commercial Fisheries
D - Duplicate

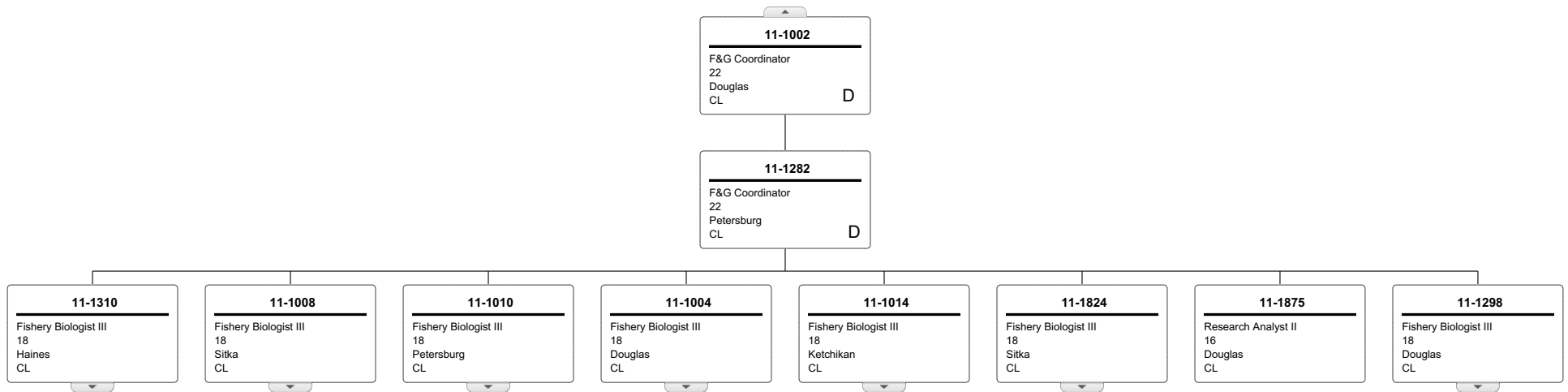

BOX TYPES
Commercial Fisheries
D - Duplicate

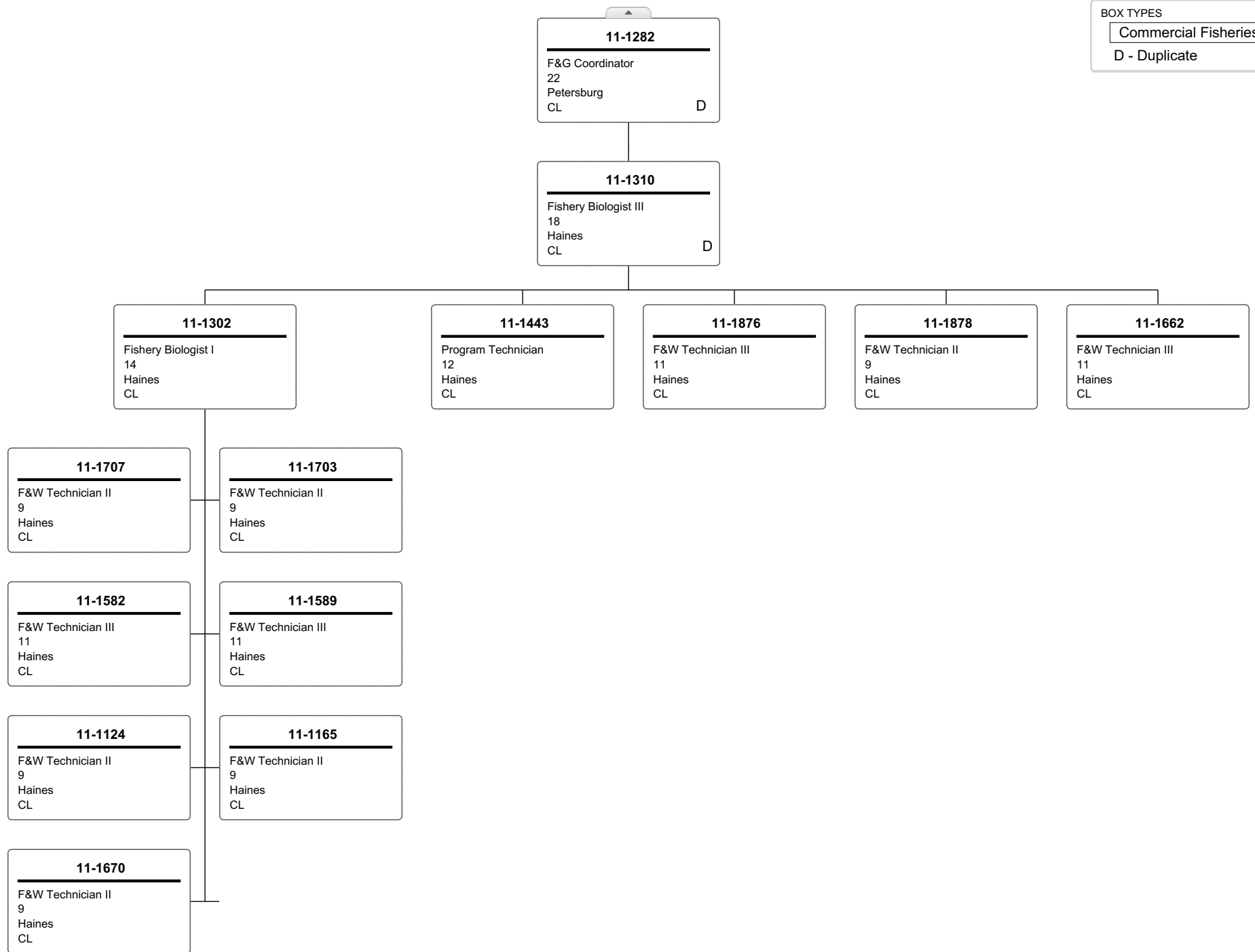

BOX TYPES
Commercial Fisheries
D - Duplicate

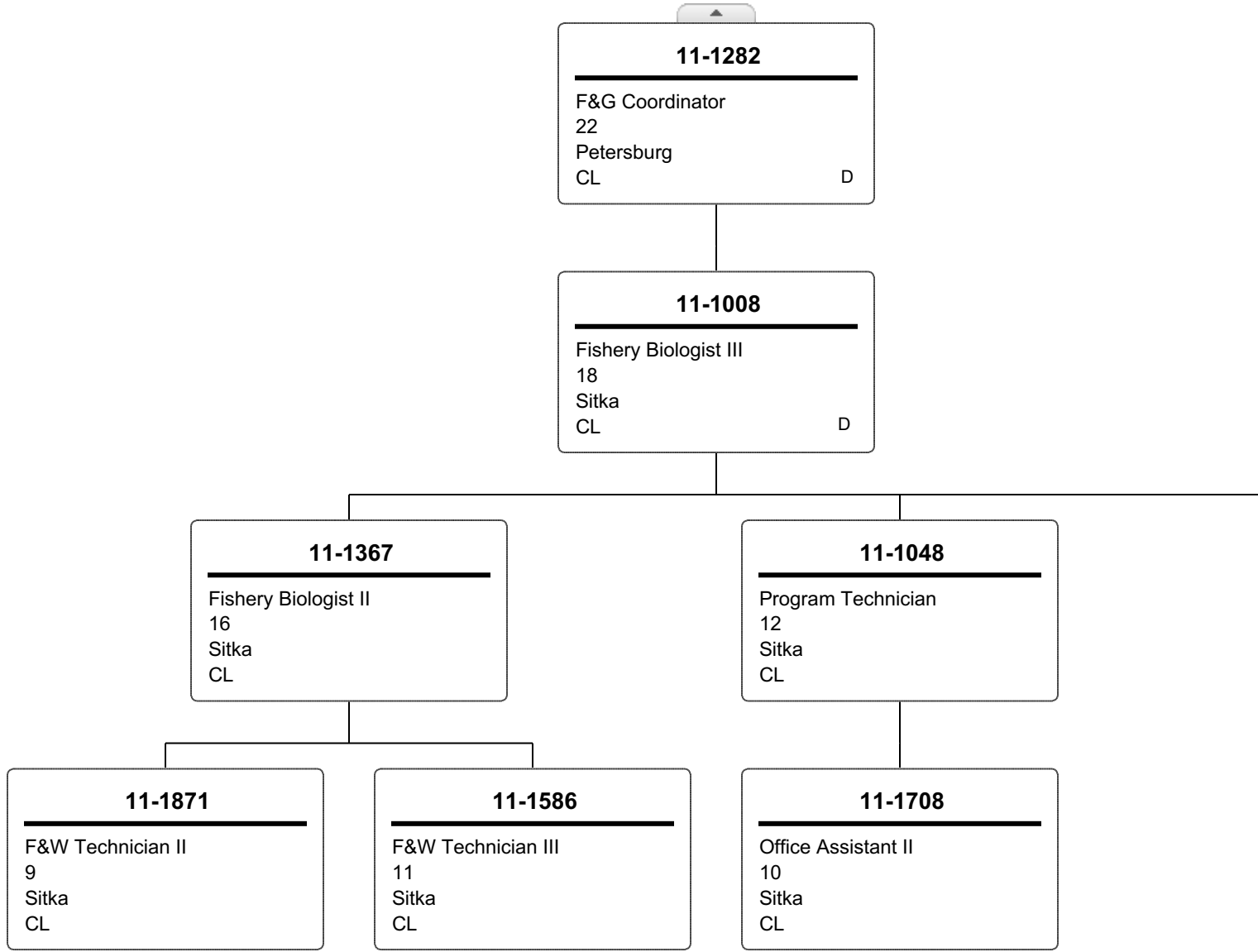

BOX TYPES
Commercial Fisheries
D - Duplicate

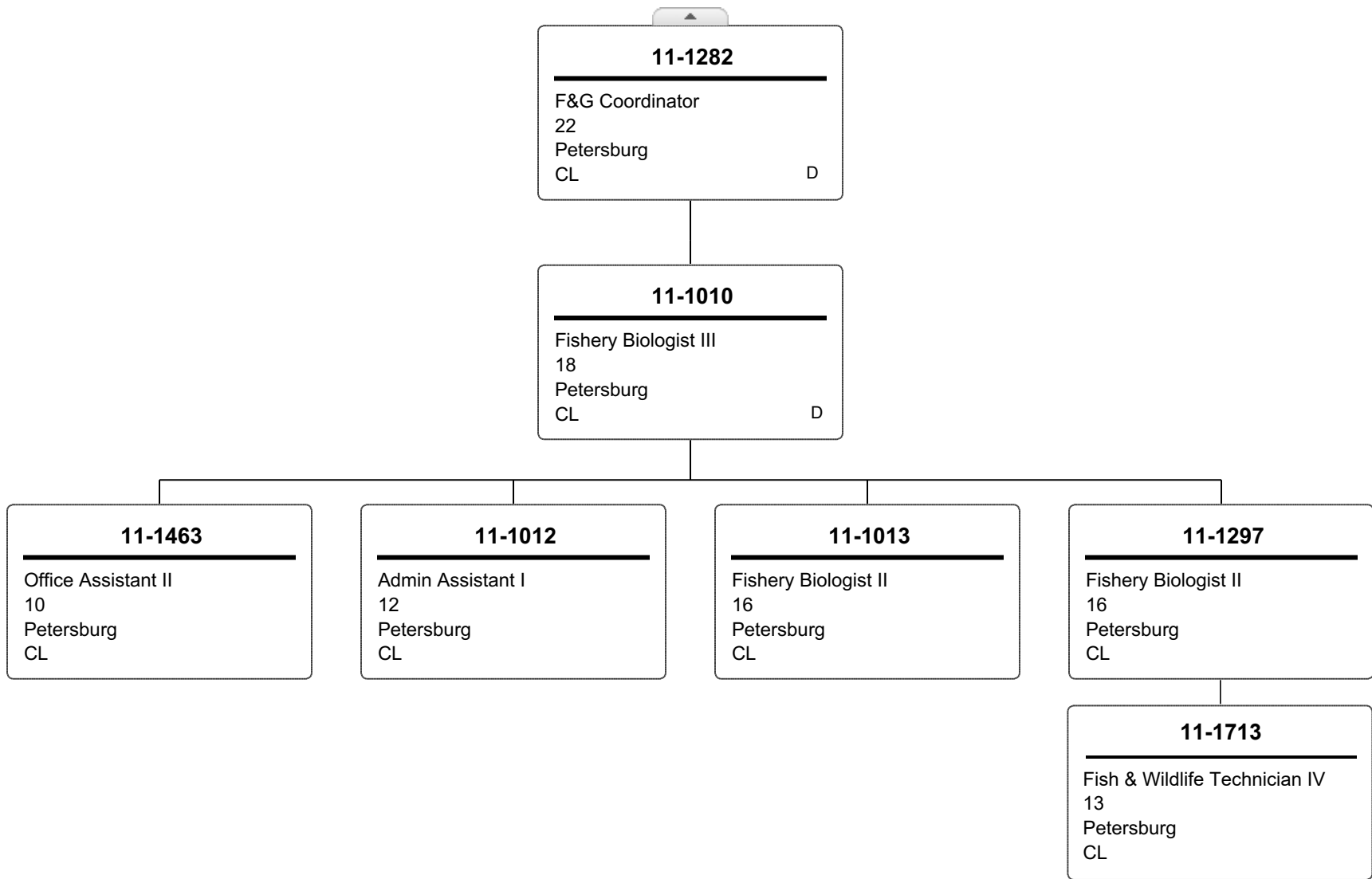

BOX TYPES
Commercial Fisheries
D - Duplicate

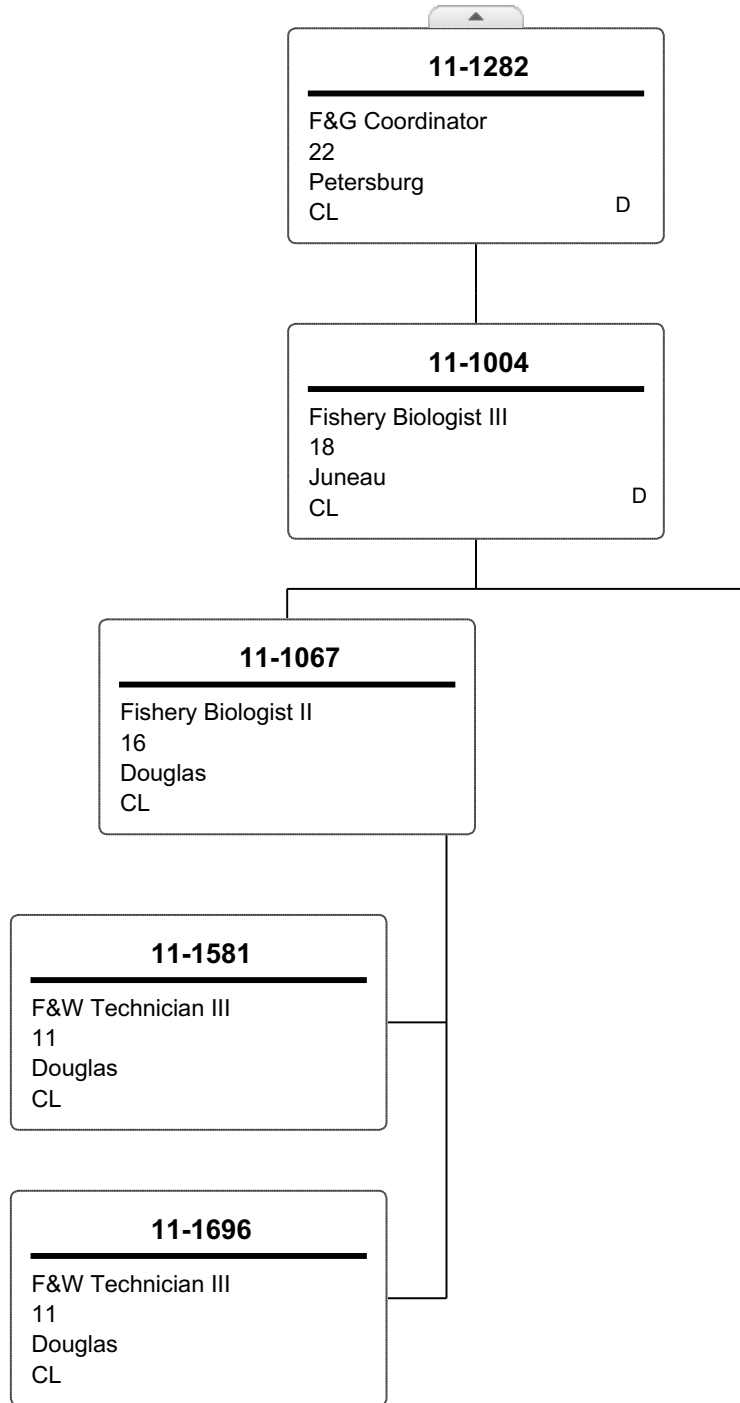

BOX TYPES
Commercial Fisheries
D - Duplicate

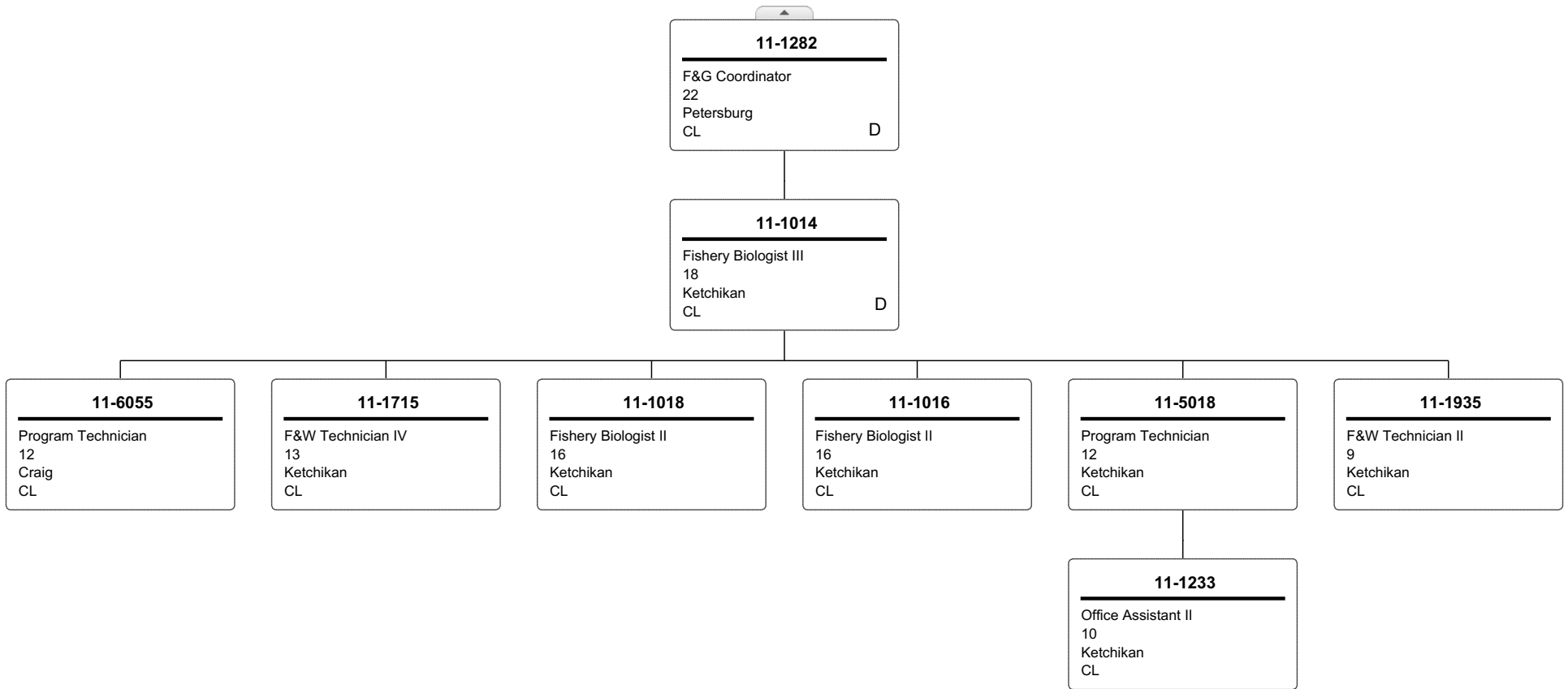

BOX TYPES
Commercial Fisheries
D - Duplicate

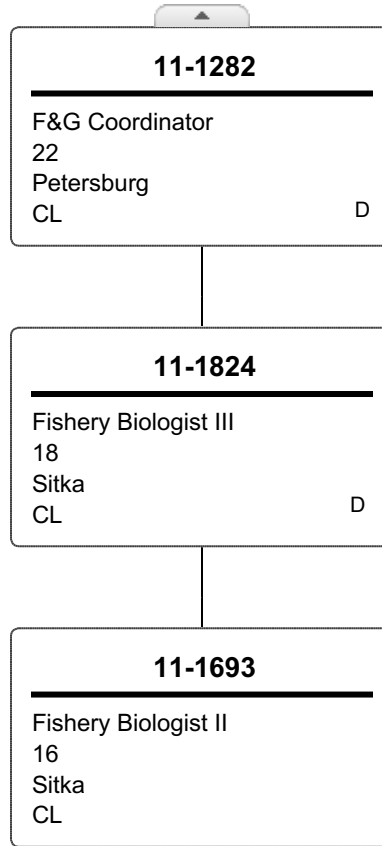

BOX TYPES
Commercial Fisheries
D - Duplicate

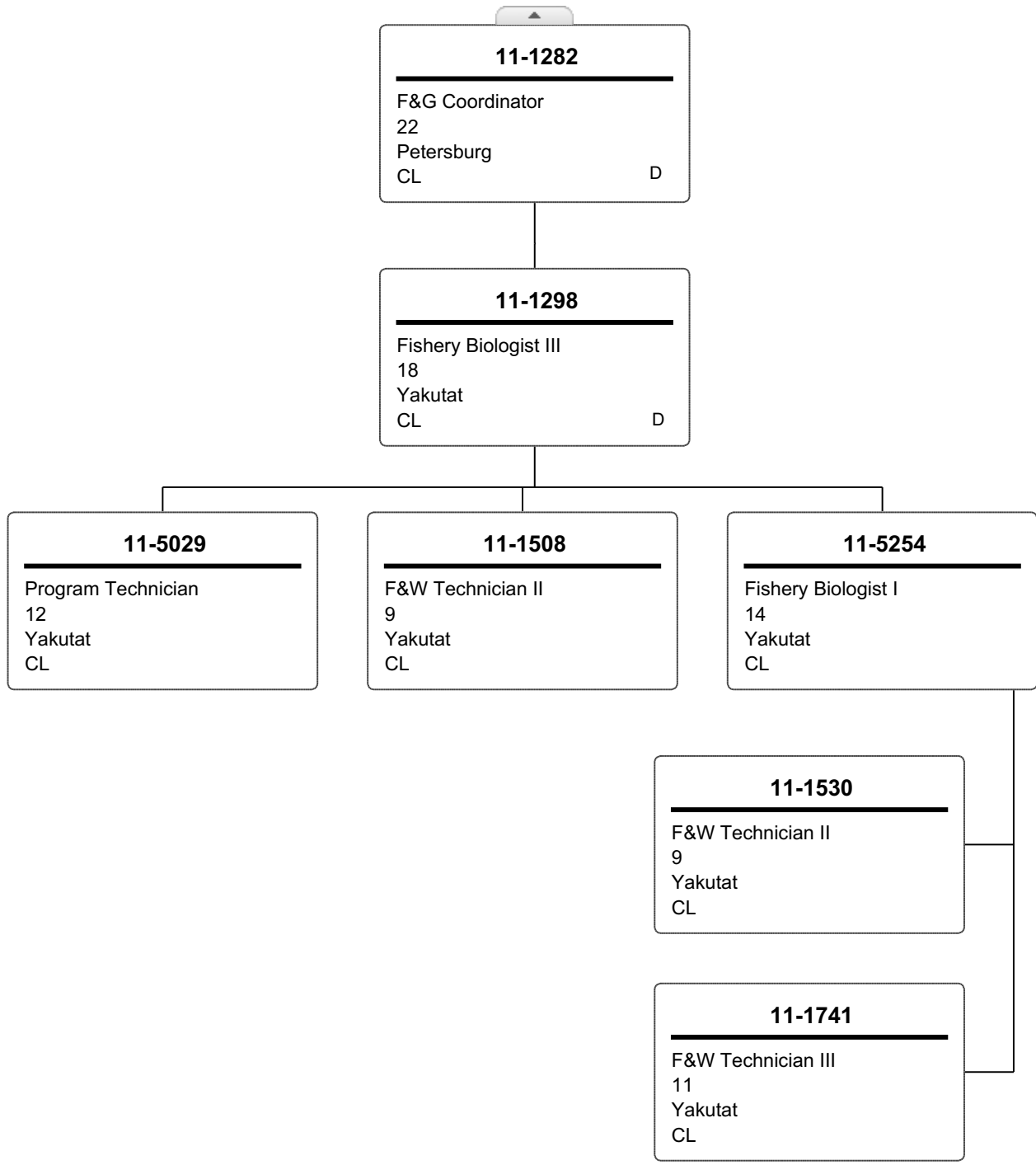

BOX TYPES
Commercial Fisheries
D - Duplicate

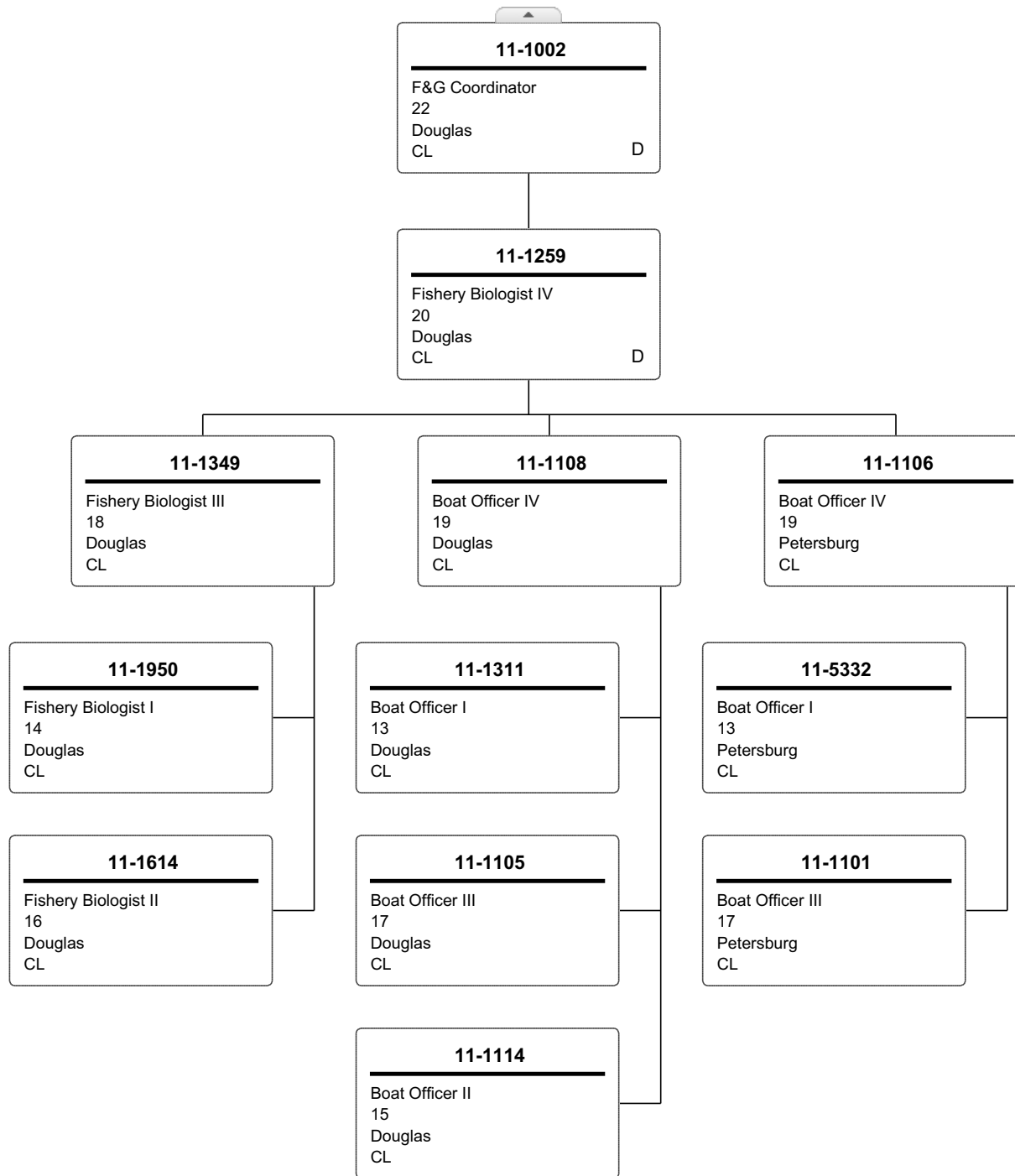

BOX TYPES
Commercial Fisheries
D - Duplicate

11-1835
Accounting Technician III
16
Douglas
CL

11-1324
Accounting Technician I
12
Douglas
CL

11-1951
Accounting Clerk
10
Douglas
CL

11-1129
Analyst/Programmer V
22
Juneau
CL D

11-1821
Analyst/Programmer IV
20
Douglas
CL

11-1218
Administrative Officer I
17
Douglas
CL

11-5027
Administrative Assistant II
14
Douglas
CL