

Department of Health
FY2023 Governor's Budget
Health Care Services
Medical Assistance Administration

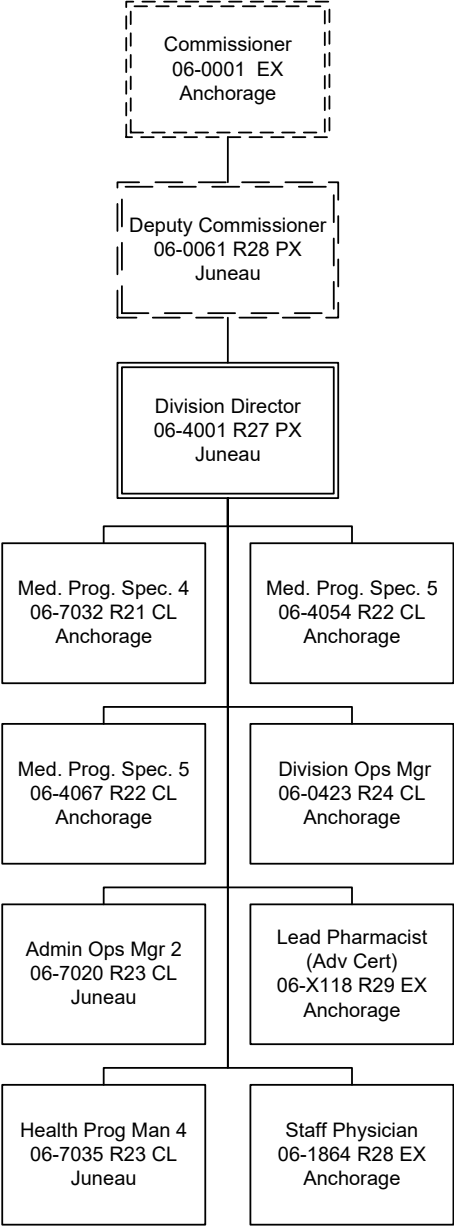

Administrative Operations

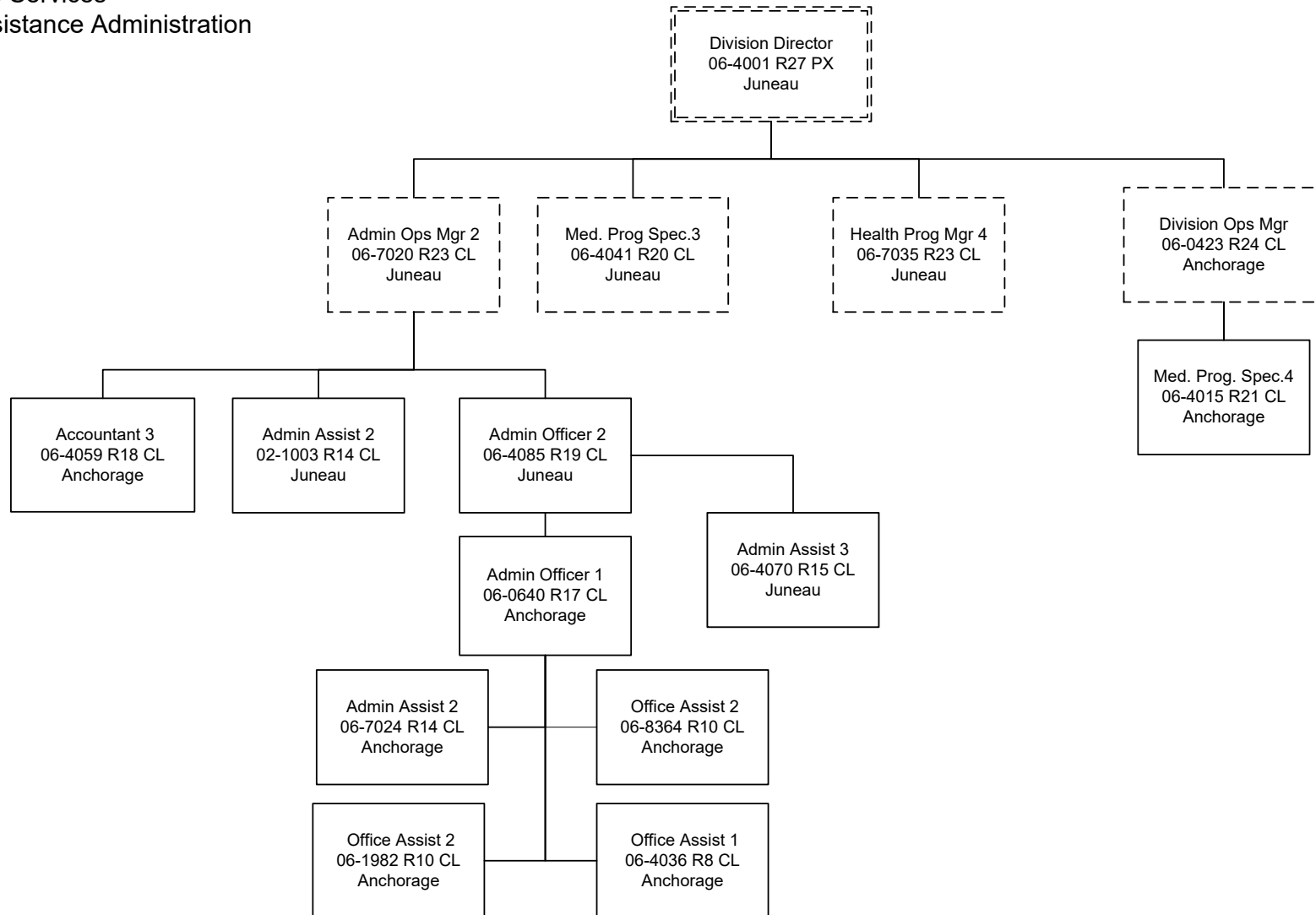

Accounting and Recovery

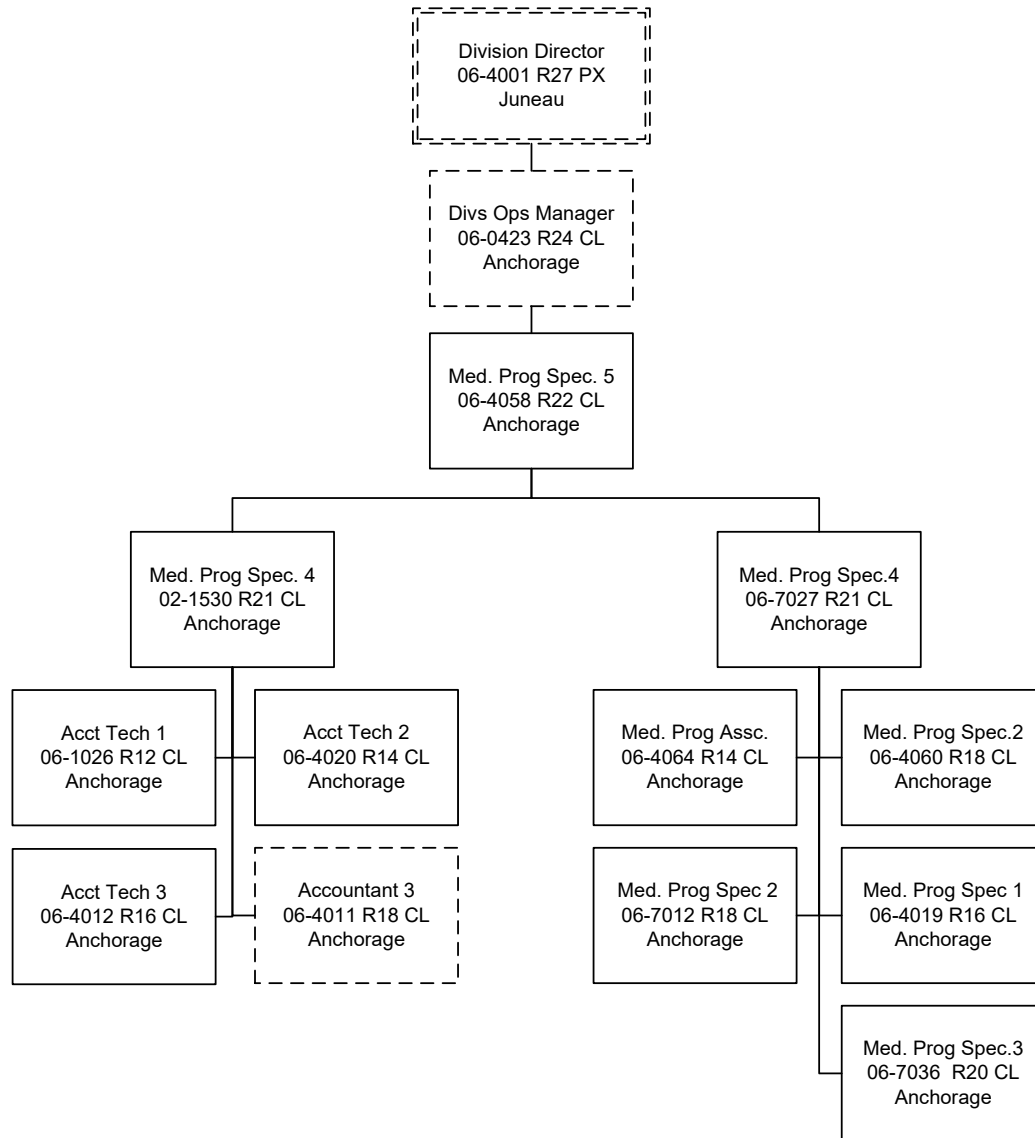

Systems

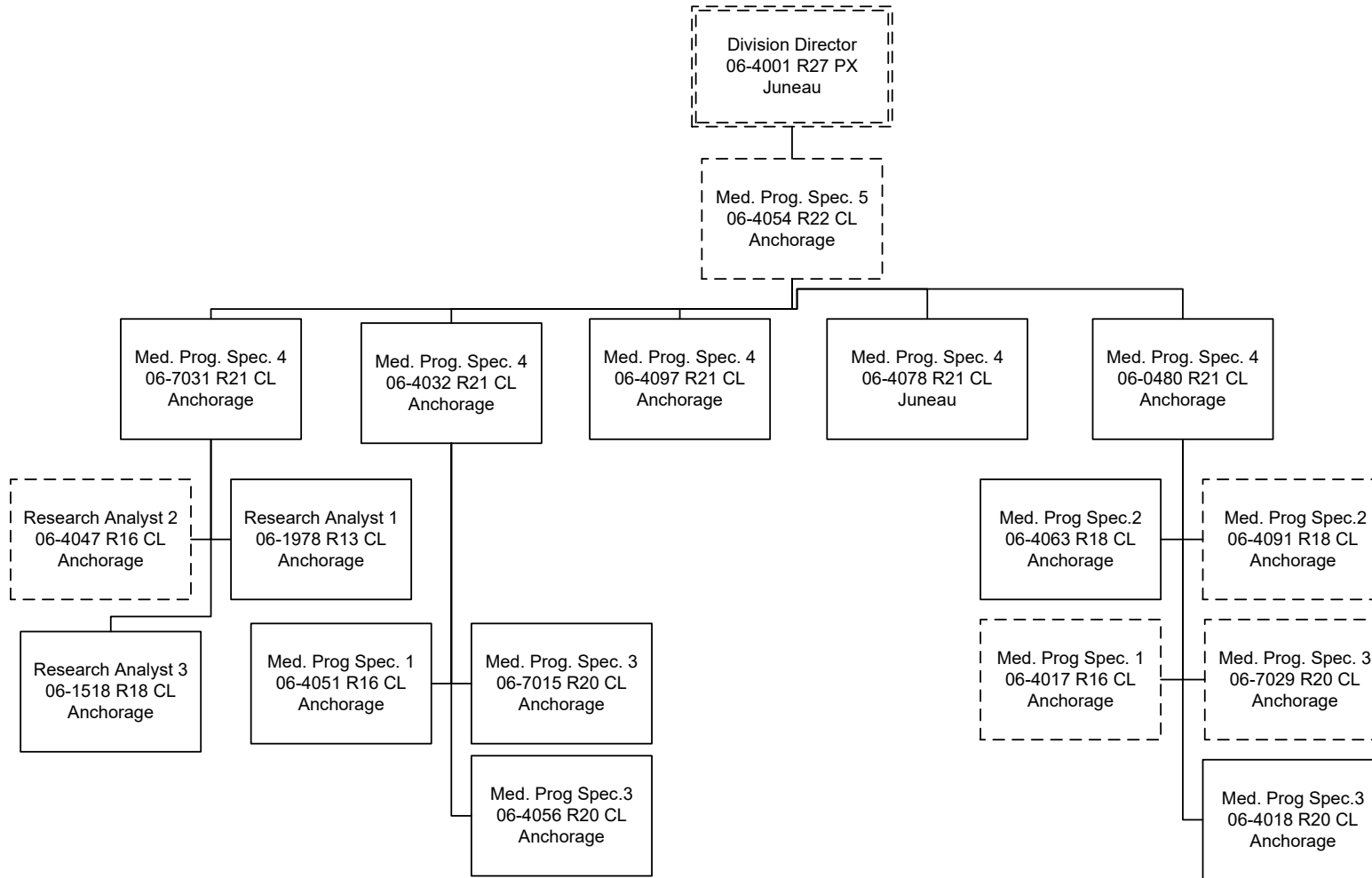

Medicaid Physician, Pharmacy, and Ancillary

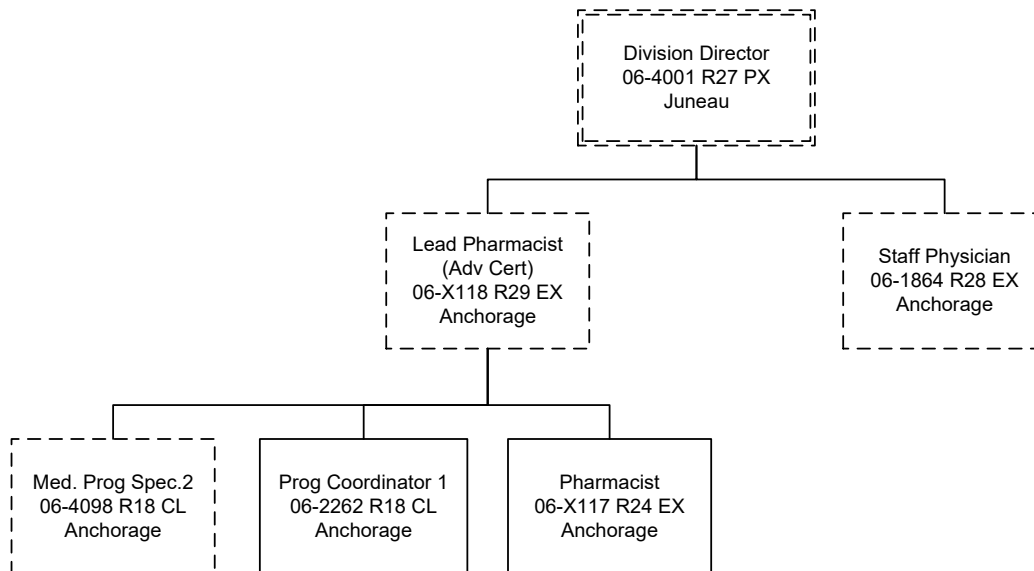

Operations

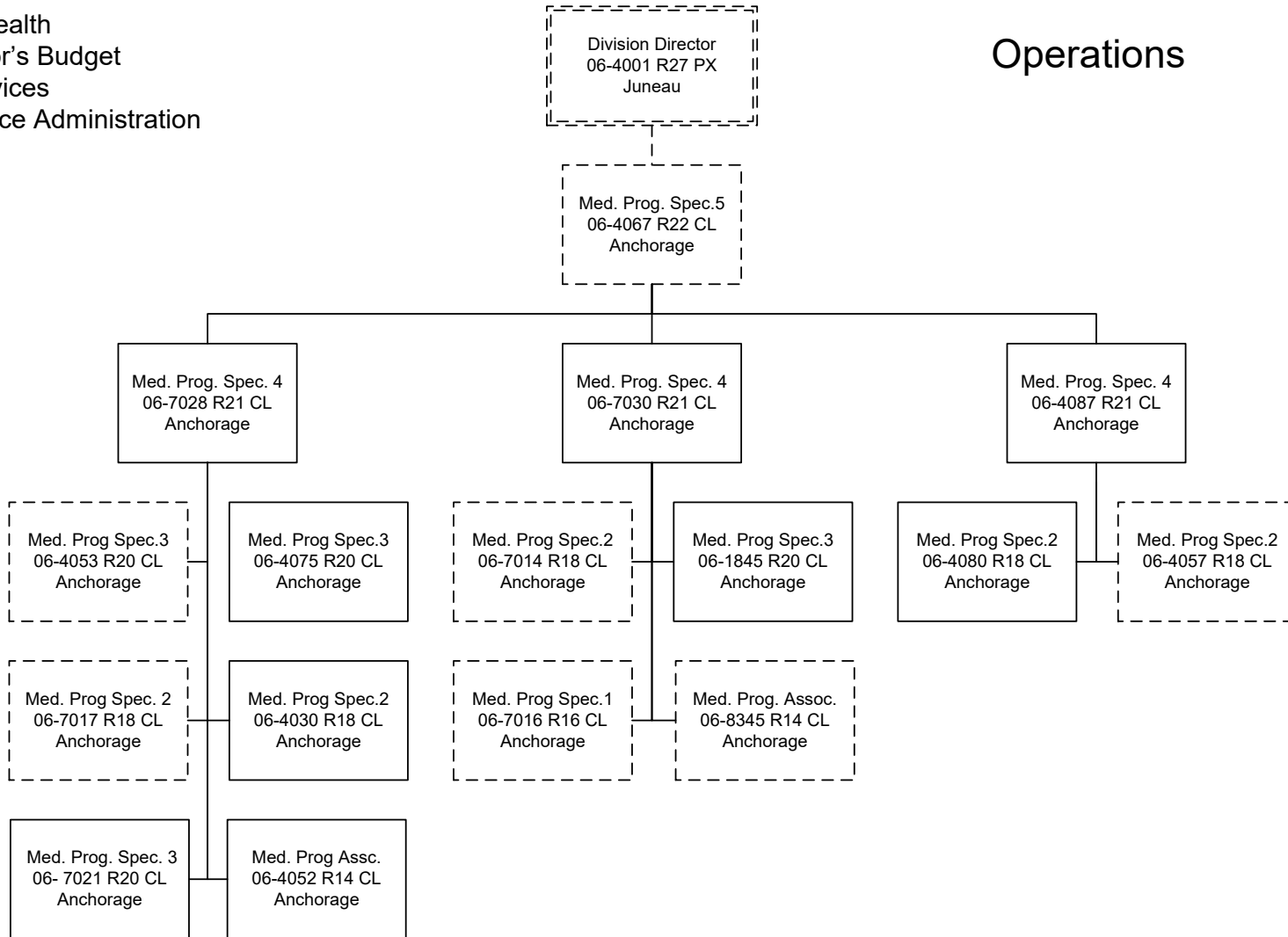

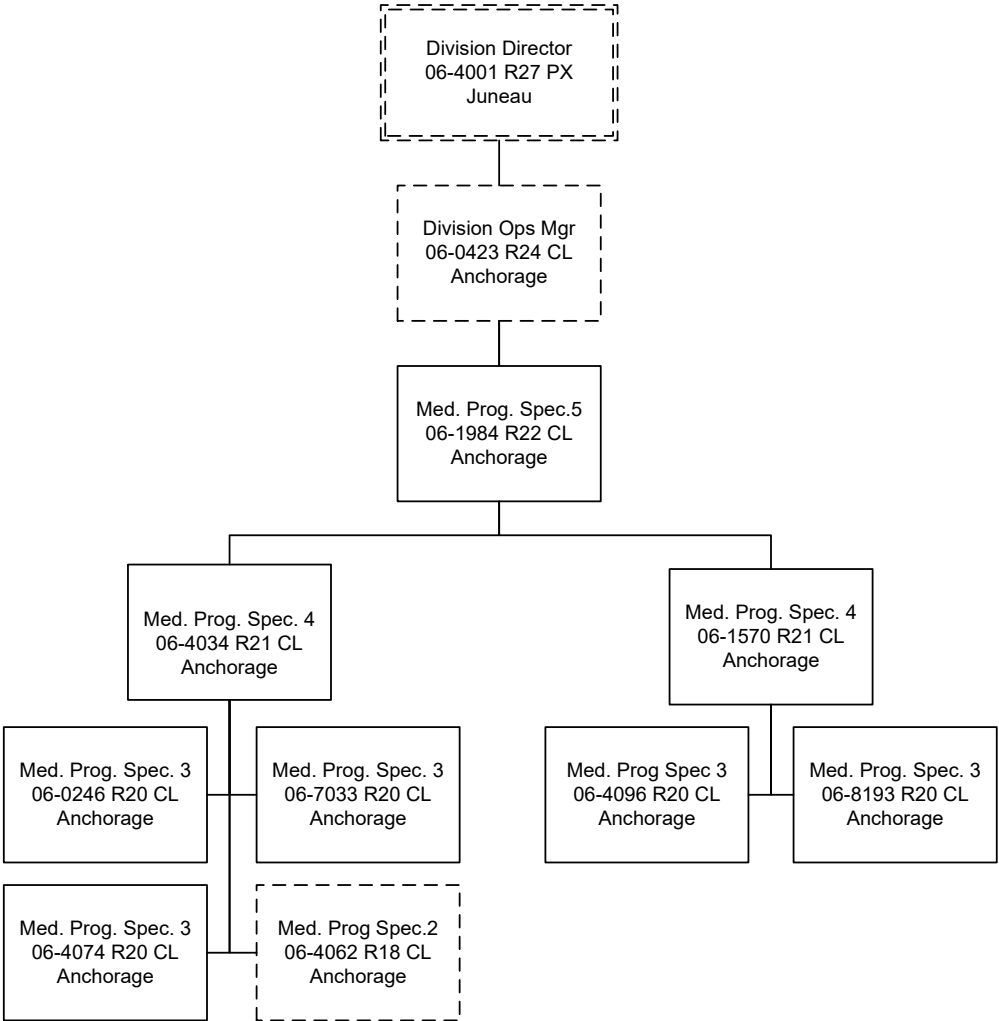

Department of Health
FY2023 Governor's Budget
Health Care Services
Medical Assistance Administration
Tribal Health Program

Tribal Health Program

