

State of Alaska FY2024 Governor's Operating Budget

Department of Administration Alaska Division of Information Technology RDU/Component Budget Summary

RDU/Component: Alaska Division of Information Technology

Contribution to Department's Mission

Provide a robust and secure information technology infrastructure together with enterprise services that support state agencies' business needs.

Results

(Additional performance information is available on the web at <https://omb.alaska.gov/results>.)

Core Services

- Secure and assure the integrity of state information, engineer secure solutions to benefit of the State, and respond appropriately to all security incidents to mitigate impact.
- Administration, management and maintenance of the State's enterprise IT infrastructure that includes the Wide Area Network (WAN), Mainframe computing platform, the SOA Private Cloud (the multi-tenant secure hosting platform), and facilities.
- Administration, management and support for Enterprise Applications: Messaging & Directory Services, Web Services including credit card processing, myAlaska, electronic signature, and SharePoint.
- End User Services - Service Desk Manager and WebHelpDesk ticketing systems; hardware deployment and demobilization; productivity tools training; software deployment; accounting provisioning and recovery.
- Core Telephony (JNU-ANC-FAI) Internet Protocol (IP) phone system; Microsoft Teams Phones; Mobile Device Management; Audio & Video conferencing; Secure Network Services; VPN; Internet & Wireless connectivity; and call center platform services.

Measures by Core Service

(Additional performance information is available on the web at <https://omb.alaska.gov/results>.)

- 1. Secure and assure the integrity of state information, engineer secure solutions to benefit of the State, and respond appropriately to all security incidents to mitigate impact.**
- 2. Administration, management and maintenance of the State's enterprise IT infrastructure that includes the Wide Area Network (WAN), Mainframe computing platform, the SOA Private Cloud (the multi-tenant secure hosting platform), and facilities.**
- 3. Administration, management and support for Enterprise Applications: Messaging & Directory Services, Web Services including credit card processing, myAlaska, electronic signature, and SharePoint.**

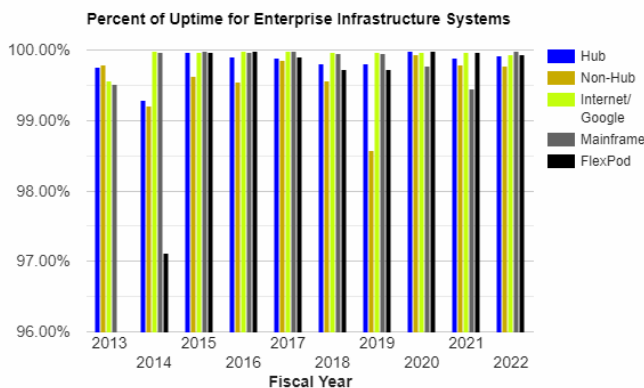

- 4. End User Services - Service Desk Manager and WebHelpDesk ticketing systems; hardware deployment and demobilization; productivity tools training; software deployment; accounting**

provisioning and recovery.

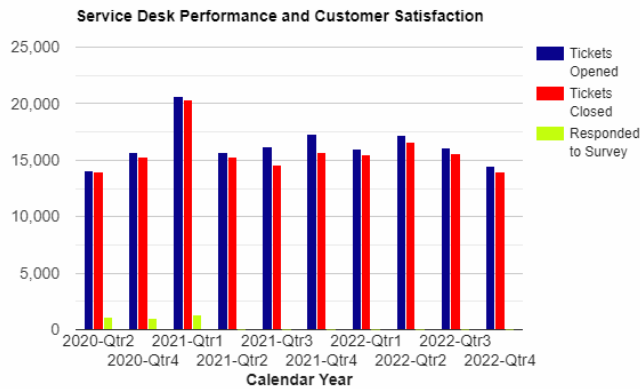

5. Core Telephony (JNU-ANC-FAI) Internet Protocol (IP) phone system; Microsoft Teams Phones; Mobile Device Management; Audio & Video conferencing; Secure Network Services; VPN; Internet & Wireless connectivity; and call center platform services.

Major Component Accomplishments in 2022

- Continued implementation of the Teams Voice system to include migrating 4,400 Cisco phone lines to Teams Voice Phones and enhancing data for emergency locations services for the safety of our remote workforce. This creates network flexibility for outages and allows us to replace non-proprietary assets and tools.
- Modernization and upgrade of the State of Alaska (SOA) Enterprise Wireless service to add the ability for self-registration for guest-users of the enterprise wireless. Completion of our multi-year capital project to increase rural broadband connectivity.
- In efforts to modernize to Microsoft Azure Cloud and other vendor off-premises Software as a Service (SaaS) solutions we have seen many systems evaluated and began movement towards off-premises workloads. We have provisioned and support public cloud tenants in Azure Commercial, Azure Government, as well as Oracle Cloud Infrastructure for tenant appropriate workloads as determined.
- Laid the foundation to remove/reduce third-party tools to centralize management and standardize configuration and improve security on all workstations, laptops, and mobile devices uniformly with the patching, remote control, imaging, and software deployment for multiple departments on over tens of thousands of assets.
- Enabled 24/7 security operations to include an incident response retainer. Significant efforts to protect SOA employees, increasing to approximately 86% of the executive branch employees using Multi-Factor Authentication (MFA) when logging onto connected devices. Additionally, instituted required monthly email exercises targeting all executive branch employees to train against phishing and security attacks.

Key Component Challenges

Financial component challenges include lifecycle replacement plan of equipment and lack of dedicated funding. We have increased risk associated with out of support assets. Management risk dictates the component will spend time and resources on asset discovery and management tools to create a comprehensive statewide inventory management, to inform our cybersecurity maturity assessment.

An ongoing challenge for OIT remains in the implementation of the IT consolidation, as we continue the centralization of services, such as multi-departmental service delivery teams to increase depth of coverage, knowledge sharing and standardizations. We continued to expend OIT resources in effort to communicate and realize the readiness of executing modernization across State agencies.

Significant Changes in Results to be Delivered in FY2024

In FY2024, we will continue to implement our cyber security strategy and cloud service migrations to best protect Alaskans. We will also continue maturing within our organization in alignment with the Commissioner's Alaska Administrative Productivity and Excellence (AAPEX) charters. Charters include items such as Chargeback Model and End User Device working groups, in addition to Service Catalog life cycles. This will increase focus on business process integration and partnership with our State agency customers, to realize maximum efficiency and ongoing quality improvement efforts.

Statutory and Regulatory Authority

AS 44.21.020(9) (10) Duties of Department
AS 44.21.045 Information Services Fund
AS 44.21.150-170 Automatic Data Processing
AS 44.21.305-390 Telecommunications
2 AAC 21 Information Services

Contact Information
<p>Contact: Bill Smith, Chief Information Officer Phone: (907) 465-2220 E-mail: bill.smith@alaska.gov</p>

Alaska Division of Information Technology Personal Services Information				
Authorized Positions			Personal Services Costs	
	FY2023 Management Plan	FY2024 Governor		
Full-time	224	224	Annual Salaries	21,248,697
Part-time	0	0	COLA	549,453
Nonpermanent	1	1	Premium Pay	423,226
			Annual Benefits	12,518,831
			<i>Less 5.59% Vacancy Factor</i>	<i>(1,943,607)</i>
			Lump Sum Premium Pay	0
Totals	225	225	Total Personal Services	32,796,600

Position Classification Summary					
Job Class Title	Anchorage	Fairbanks	Juneau	Others	Total
Accountant 2	0	0	1	0	1
Accountant 4	0	0	1	0	1
Accountant 5	0	0	1	0	1
Accounting Technician 1	0	0	1	0	1
Accounting Technician 2	0	0	1	0	1
Administrative Assistant 3	0	0	2	0	2
Administrative Officer 2	1	0	0	0	1
Admn OPS Mgr 2	0	0	1	0	1
Analyst/Programmer 4	1	0	0	0	1
Analyst/Programmer 5	0	0	1	0	1
Bus An/IA 3	0	0	1	0	1
Chief Technology Officer 3	0	0	4	0	4
Data Comm Sp 1	4	1	1	0	6
Data Comm Sp 2	4	2	2	0	8
Data Processing Manager 1	7	1	4	0	12
Data Processing Manager 2	3	0	0	0	3
Data Processing Manager 3	3	0	0	0	3
Data Processing Technician 2	2	0	6	0	8
Database Specialist 1	1	0	0	0	1
Database Specialist 2	1	0	1	0	2
Database Specialist 3	1	0	3	0	4
Dep Chf Inf Ofc	1	0	0	0	1
DP Prod Mgr	1	0	1	0	2
DPT Tech Ofc 2	7	0	4	0	11
DPT Tech Ofc 3	2	0	2	0	4
Internet Specialist 2	1	0	1	0	2
Micro/Net Sp 1	19	1	8	0	28
Micro/Net Sp 2	7	3	4	1	15
Micro/Net Tc 1	0	1	0	0	1
Micro/Net Tc 2	21	1	10	2	34
Office Assistant 2	1	0	0	0	1
P3 Manager	1	0	2	0	3
Program Coordinator 2	0	0	2	0	2
St Chf Inf Ofc	1	0	0	0	1
Staff Manager, Oit	1	0	0	0	1
Systems Programmer 1	3	0	2	0	5

Position Classification Summary

Job Class Title	Anchorage	Fairbanks	Juneau	Others	Total
Systems Programmer 2	19	1	10	0	30
Systems Programmer 3	9	1	7	1	18
Systems Programmer 4	2	0	0	0	2
Tech Arch Spec	0	0	1	0	1
Totals	124	12	85	4	225

Component Detail All Funds
Department of Administration

Component: Alaska Division of Information Technology (3141)
RDU: Office of Information Technology (653)

Non-Formula Component

	FY2022 Actuals	FY2023 Conference Committee	FY2023 Authorized	FY2023 Management Plan	FY2024 Governor	FY2023 Management Plan vs FY2024 Governor	
71000 Personal Services	31,374.7	33,804.8	33,886.9	31,383.4	32,796.6	1,413.2	4.5%
72000 Travel	30.7	84.9	84.9	84.9	126.2	41.3	48.6%
73000 Services	27,799.9	26,979.2	28,663.0	31,166.5	28,361.8	-2,804.7	-9.0%
74000 Commodities	98.8	571.6	571.6	571.6	571.6	0.0	0.0%
75000 Capital Outlay	3,035.9	2,480.0	2,480.0	2,480.0	2,820.9	340.9	13.7%
77000 Grants, Benefits	0.0	0.0	0.0	0.0	0.0	0.0	0.0%
78000 Miscellaneous	0.0	0.0	0.0	0.0	0.0	0.0	0.0%
Totals	62,340.0	63,920.5	65,686.4	65,686.4	64,677.1	-1,009.3	-1.5%
Fund Sources:							
1004 Gen Fund (UGF)	2,000.9	0.0	1,680.1	1,680.1	0.0	-1,680.1	-100.0%
1007 I/A Rcpts (Other)	6,217.0	0.0	0.0	0.0	0.0	0.0	0.0%
1081 Info Svc (Other)	54,122.1	63,920.5	64,006.3	64,006.3	64,677.1	670.8	1.0%
Unrestricted General (UGF)	2,000.9	0.0	1,680.1	1,680.1	0.0	-1,680.1	-100.0%
Designated General (DGF)	0.0	0.0	0.0	0.0	0.0	0.0	0.0%
Other Funds	60,339.1	63,920.5	64,006.3	64,006.3	64,677.1	670.8	1.0%
Federal Funds	0.0	0.0	0.0	0.0	0.0	0.0	0.0%
Positions:							
Permanent Full Time	239	240	240	224	224	0	0.0%
Permanent Part Time	0	0	0	0	0	0	0.0%
Non Permanent	0	0	0	1	1	0	0.0%

Change Record Detail - Multiple Scenarios with Descriptions
Department of Administration

Component: Alaska Division of Information Technology (3141)
RDU: Office of Information Technology (653)

Scenario/Change Record Title	Trans Type	Totals	Personal Services	Travel	Services	Commodities	Capital Outlay	Grants, Benefits	Miscellaneous	Positions		NP
										PFT	PPT	
***** Changes From FY2023 Conference Committee To FY2023 Authorized *****												
FY2023 Conference Committee												
	ConfCom	63,920.5	33,804.8	84.9	26,979.2	571.6	2,480.0	0.0	0.0	240	0	0
1081 Info Svc		63,920.5										
Align Authority for Unallocated Rates Adjustments												
	Unalloc	3.7	0.0	0.0	3.7	0.0	0.0	0.0	0.0	0	0	0
1081 Info Svc		3.7										
In FY2023 unallocated rates adjustments were appropriated to the Department of Administration to provide funding for the following rates adjustments:												
FY2023 Administrative Systems Rate Adjusted Base Change \$-43.9												
FY2023 Administrative Systems Upgrade Ongoing Costs Increases \$96.5												
FY2023 Human Resources Rate Adjusted Base Change \$-10.7												
FY2023 Human Resources Rate AspireAlaska \$35.7												
FY2023 Office of Information Technology Core Services Rate Adjusted Base Rate Change \$37.5												
FY2023 Office of Information Technology Core Services Rate Infrastructure Upkeep Increase \$107.0												
FY2023 Office of Information Technology Core Services Rate Software Increases \$238.5												
FY2023 Office of Information Technology Mainframe Increases \$8.1												
FY2023 Office of Information Technology Other Non-Core Adjusted Base \$201.2												
FY2023 Travel and Accounts Payable Rate Adjusted Base Change \$-61.3												
This is the distribution of those unallocated rates to the divisions within the Department.												
24/7 Security Operations Center Implementation												
	MultiYr	1,680.1	0.0	0.0	1,680.1	0.0	0.0	0.0	0.0	0	0	0
1004 Gen Fund		1,680.1										
SLA 2022, HB281, Pg. 137, Sec. 21, SubSec b):												
The sum of \$1,700,000 is appropriated from the general fund to the Department of												
24 Administration for security monitoring services for the fiscal years ending June 30, 2022,												
25 June 30, 2023, and June 30, 2024.												
FY2023 Exempt 5% COLA												
	SalAdj	82.1	82.1	0.0	0.0	0.0	0.0	0.0	0.0	0	0	0
1081 Info Svc		82.1										
FY2023 Exempt 5% COLA: \$82.1												
Subtotal		65,686.4	33,886.9	84.9	28,663.0	571.6	2,480.0	0.0	0.0	240	0	0

Change Record Detail - Multiple Scenarios with Descriptions
Department of Administration

Component: Alaska Division of Information Technology (3141)
RDU: Office of Information Technology (653)

Scenario/Change Record Title	Trans Type	Totals	Personal Services	Travel	Services	Commodities	Capital Outlay	Grants, Benefits	Miscellaneous	Positions		NP
										PFT	PPT	
***** Changes From FY2023 Authorized To FY2023 Management Plan *****												
Transfer Five Positions to Motor Vehicles for Organizational Change												
Trout		0.0	0.0	0.0	0.0	0.0	0.0	0.0	0.0	-5	0	0
Transfer five positions from the Office of Information Technology to Motor Vehicles for information technology reorganization efforts. It has been determined that some functions of Motor Vehicles information technology services are highly specialized and should not be part of the statewide consolidation under Administrative Order 284.												
The following positions are transferred:												
Full-time Data Processing Manager 1 (12-5452), range 22, located in Anchorage												
Full-time Analyst/Programmer 3 (02-9514), range 18, located in Anchorage												
Full-time Analyst/Programmer 3 (12-5232), range 18, located in Anchorage												
Full-time Analyst/Programmer 5 (12-4701), range 22, located in Anchorage												
Full-time Analyst/Programmer 5 (12-5417), range 22, located in Anchorage												
Transfer 11 Positions to the Department of Natural Resources for Organizational Change												
Atroat		0.0	0.0	0.0	0.0	0.0	0.0	0.0	0.0	-11	0	0
Transfer 11 positions from the Office of Information Technology to the Department of Natural Resources (DNR) for information technology reorganization efforts. It has been determined that some functions of DNR information technology services are highly specialized and should not be part of the statewide consolidation under Administrative Order 284.												
The following positions are transferred:												
Full-time Data Processing Manager 1 (10-0352), range 22, located in Anchorage												
Full-time Systems Programmer 2 (10-0347), range 22, located in Anchorage												
Full-time Analyst/Programmer 5 (10-0348), range 22, located in Anchorage												
Full-time Analyst/Programmer 5 (10-0392), range 22, located in Anchorage												
Full-time Analyst/Programmer 4 (10-0289), range 20, located in Anchorage												
Full-time Analyst/Programmer 4 (10-0346), range 20, located in Anchorage												
Full-time Analyst/Programmer 4 (10-0349), range 20, located in Anchorage												
Full-time Analyst/Programmer 4 (10-0403), range 20, located in Anchorage												
Full-time Analyst/Programmer 3 (10-0379), range 18, located in Anchorage												
Full-time Analyst/Programmer 3 (10-3105), range 18, located in Anchorage												
Full-time Analyst/Programmer 2 (10-0295), range 16, located in Anchorage												
Align Authority with Anticipated Services Costs												
LIT		0.0	-2,503.5	0.0	2,503.5	0.0	0.0	0.0	0.0	0	0	0
Transfer authority from personal services to cover anticipated services costs. The remaining personal services authority is sufficient to cover anticipated expenditures.												

Change Record Detail - Multiple Scenarios with Descriptions
Department of Administration

Component: Alaska Division of Information Technology (3141)
RDU: Office of Information Technology (653)

Scenario/Change Record Title	Trans Type	Totals	Personal Services	Travel	Services	Commodities	Capital Outlay	Grants, Benefits	Miscellaneous	Positions		NP
										PFT	PPT	
Create a Long-Term Non-Permanent Systems Programmer 4 (02-N18007) to Manage Ongoing Mainframe Activities												
	PosAdj	0.0	0.0	0.0	0.0	0.0	0.0	0.0	0.0	0	0	1
The Department of Administration, Alaska Division of Information Technology, is adding a long-term non-permanent position to the budget to address the ongoing mainframe activities that have resulted from an ongoing migration of State of Alaska servers to the cloud model. This position will likely exist until migration activities have been completed.												
The following positions is created:												
Part-time, non-permanent, Systems Programmer 4 (02-N18007), range 25, located in Anchorage												
Subtotal		65,686.4	31,383.4	84.9	31,166.5	571.6	2,480.0	0.0	0.0	224	0	1
***** Changes From FY2023 Management Plan To FY2024 Governor *****												
Align Authority with Anticipated Personal Services, Travel, and Equipment Replacement Costs												
	LIT	0.0	742.4	41.3	-1,124.6	0.0	340.9	0.0	0.0	0	0	0
Transfer authority from services and supplies, to cover anticipated personal services, travel, and equipment replacement costs. The remaining services authority is sufficient to cover anticipated expenditures.												
Reverse 24/7 Security Operations Center Implementation												
	OTI	-1,680.1	0.0	0.0	-1,680.1	0.0	0.0	0.0	0.0	0	0	0
1004 Gen Fund		-1,680.1										
SLA 2022, HB281, Pg. 137, Sec. 21, SubSec b):												
The sum of \$1,700,000 is appropriated from the general fund to the Department of Administration for security monitoring services for the fiscal years ending June 30, 2022, June 30, 2023, and June 30, 2024.												
FY2024 Salary and Health Insurance Increases												
	SalAdj	600.0	600.0	0.0	0.0	0.0	0.0	0.0	0.0	0	0	0
1081 Info Svc		600.0										
FY2024 Salary and Health Insurance Increases: \$600.0FY2024 GGU cost of living increase 2.5%: \$421.3												
FY2024 SU cost of living increase 1%: \$93.0												
FY2024 AlaskaCare insurance from \$1,685 to \$1,793 per member per month.: \$75.2												
FY2024 GGU health insurance increase from \$1,567.50 to \$1,573.50 per member per month.: \$10.5												

Change Record Detail - Multiple Scenarios with Descriptions
Department of Administration

Component: Alaska Division of Information Technology (3141)
RDU: Office of Information Technology (653)

Scenario/Change Record Title	Trans Type	Totals	Personal Services	Travel	Services	Commodities	Capital Outlay	Grants, Benefits	Miscellaneous	Positions		NP
										PFT	PPT	
FY2024 PERS Rate Adjustment												
1081 Info Svc	SalAdj	62.3	62.3	0.0	0.0	0.0	0.0	0.0	0.0	0	0	0
FY2024 PERS rate adjustment to 25.10%: \$62.3												
FY2024 AlaskaCare Health Insurance Increase - Exempt and Partially Exempt												
1081 Info Svc	SalAdj	8.5	8.5	0.0	0.0	0.0	0.0	0.0	0.0	0	0	0
FY2024 AlaskaCare health insurance increase for exempt and partially exempt employees from \$1,685 to \$1,793 per member per month.: \$8.5												
Totals		64,677.1	32,796.6	126.2	28,361.8	571.6	2,820.9	0.0	0.0	224	0	1

Line Item Detail (1676)
Department of Administration
Travel

Component: Alaska Division of Information Technology (3141)

Line Number	Line Name		FY2022 Actuals	FY2023 Management Plan	FY2024 Governor
2000	Travel		30.7	84.9	126.2
Object Class	Servicing Agency	Explanation	FY2022 Actuals	FY2023 Management Plan	FY2024 Governor
2000 Travel Detail Totals			30.7	84.9	126.2
2000	In-State Employee Travel	Transportation costs for travel relating to administration, training, conventions and meetings, boards and commissions	30.7	60.7	116.2
2000	In-State Employee Travel	Uncollectible Information Services Fund (ISF) authority	0.0	14.2	0.0
2002	Out of State Employee Travel	Transportation costs for staff travel out of state to national organization meetings, conferences, and training	0.0	10.0	10.0

Line Item Detail (1676)
Department of Administration
Services

Component: Alaska Division of Information Technology (3141)

Line Number	Line Name		FY2022 Actuals	FY2023 Management Plan	FY2024 Governor
3000	Services		27,799.9	31,166.5	28,361.8
Object Class	Servicing Agency	Explanation	FY2022 Actuals	FY2023 Management Plan	FY2024 Governor
3000 Services Detail Totals			27,470.0	31,166.5	28,361.8
3000	Education Services	Training, educational conferences, agency memberships, and employee tuition	193.1	212.8	316.7
3001	Financial Services	Management and consulting services	0.1	0.0	0.0
3003	Information Technology	Software licensing and maintenance, training, and consulting	21,374.3	21,781.7	21,781.7
3003	Information Technology	Inflationary impacts on existing ISF contracts	0.0	0.0	0.0
3003	Information Technology	IT Asset replacement consulting and installation	0.0	0.0	0.0
3004	Telecommunications	Local, long distance, and cellular telephone charges, television, data/network, telecommunication equipment, and other wireless charges from outside vendors	2,988.1	2,789.4	2,979.8
3006	Delivery Services	Freight, courier services, and postage	3.8	9.9	15.9
3008	Utilities	Electricity, heating fuel, water, sewage, and disposal services	0.0	0.0	70.0
3009	Structure/Infrastructure/Land	Structure, infrastructure and land repairs, maintenance, rental, and leases	9.9	52.4	29.5
3010	Equipment/Machinery	Machinery, furniture and office equipment purchase, repairs, maintenance, rentals, and leases	449.9	489.3	435.3

Line Item Detail (1676)
Department of Administration
Services

Component: Alaska Division of Information Technology (3141)

Object Class		Servicing Agency	Explanation	FY2022 Actuals	FY2023 Management Plan	FY2024 Governor
3000 Services Detail Totals				27,470.0	31,166.5	28,361.8
3011	Other Services		Management/consulting fees; printing, copying & graphic services; safety services	202.9	212.5	78.5
3011	Other Services		Uncollectible Information Services Fund (ISF) authority	0.0	2,894.5	0.0
3017	Inter-Agency Information Technology Non-Telecommunications	Admin - Labor Agreements Misc Items (2054)	OIT Core Services (Adobe Pass-through)	0.0	0.0	0.0
3020	Inter-Agency Building Maintenance	NatRes - Department-wide	Building maintenance services	10.7	25.0	25.0
3021	Inter-Agency Mail	Admin - Print Services (2333)	Centralized mail services chargeback	2.3	4.1	4.5
3022	Inter-Agency Human Resources	Admin - Personnel (56)	Human resource chargeback and payroll services provided by the Division of Personnel	158.1	135.0	135.5
3023	Inter-Agency Building Leases	Trans - Department-wide	Rent for state-owned facilities and lease payments	764.3	1,106.4	1,110.6
3026	Inter-Agency Insurance	Admin - Risk Management (71)	Division of Risk Management - Risk management insurance charges	14.2	29.2	29.2
3027	Inter-Agency Financial	Admin - Accounting (3134)	SSoA Accounts Payable and Travel Chargeback	99.1	99.0	99.0
3027	Inter-Agency Financial	Admin - Finance (59)	Division of Finance Chargeback for IRIS FIN, HRM, and ALDER	11.6	20.0	20.0
3028	Inter-Agency Americans with Disabilities Act Compliance	Admin - Personnel (56)	Americans with Disabilities Act (ADA) Chargeback	2.1	2.1	2.1
3037	State Equipment Fleet	Trans - Department-wide	State equipment fleet chargeback for vehicle lease, maintenance, and fuel	12.4	9.9	9.5
3038	Inter-Agency Management/Consulting	Admin - Administrative Services (46)	Support services provided by the Division of Administrative Services Chargeback	733.6	381.4	381.4
3038	Inter-Agency Management/Consulting	Admin - OFC of Procure. Property. Mngmt. (3291)	SSoA Procurement Chargeback	322.3	350.0	350.0
3038	Inter-Agency	Admin - Office of the Commissioner	Support services provided by the	0.0	415.9	381.6

Line Item Detail (1676)
Department of Administration
Services

Component: Alaska Division of Information Technology (3141)

Object Class	Servicing Agency	Explanation	FY2022 Actuals	FY2023 Management Plan	FY2024 Governor
3000 Services Detail Totals			27,470.0	31,166.5	28,361.8
	Management/Consulting	(45) Office of the Commissioner			
3038	Inter-Agency Management/Consulting	FishGm - Department-wide DFG Acting DTO	34.2	40.0	0.0
3038	Inter-Agency Management/Consulting	Trans - Department-wide Electrical consumption costs	83.0	106.0	106.0

Line Item Detail (1676)
Department of Administration
Commodities

Component: Alaska Division of Information Technology (3141)

Line Number	Line Name		FY2022 Actuals	FY2023 Management Plan	FY2024 Governor
4000	Commodities		98.8	571.6	571.6
Object Class	Servicing Agency	Explanation	FY2022 Actuals	FY2023 Management Plan	FY2024 Governor
4000 Commodities Detail Totals			98.8	571.6	571.6
4000	Business	Uncollectible Information Services Fund (ISF) authority	97.1	570.1	570.1
4000	Business	IT Asset replacement	0.0	0.0	0.0
4002	Household/Institutional	Cleaning, food and other household supplies	1.7	1.5	1.5

Line Item Detail (1676)
Department of Administration
Capital Outlay

Component: Alaska Division of Information Technology (3141)

Line Number	Line Name		FY2022 Actuals	FY2023 Management Plan	FY2024 Governor
5000	Capital Outlay		3,035.9	2,480.0	2,820.9
Object Class	Servicing Agency	Explanation	FY2022 Actuals	FY2023 Management Plan	FY2024 Governor
5000 Capital Outlay Detail Totals			3,035.9	2,480.0	2,820.9
5004	Equipment	Equipment costs	3,035.9	1,204.5	0.0
5004	Equipment	IT Asset replacement	0.0	0.0	0.0
5004	Equipment	Uncollectible Information Services Fund (ISF) authority	0.0	1,275.5	2,820.9

Revenue Detail (1681)
Department of Administration

Component: Alaska Division of Information Technology (3141)

Revenue Type (OMB Fund Code) Revenue Source	Component	Comment	FY2022 Actuals	FY2023 Management Plan	FY2024 Governor
5007 I/A Rcpts (1007 I/A Rcpts)			6,133.0	0.0	0.0
5301 Inter-Agency Receipts	Admin - Accounting (3134)	Microsoft and Adobe Passthrough Chargeback	1.6	0.0	0.0
5301 Inter-Agency Receipts	Admin - Administrative Hearings (2771)	Microsoft and Adobe Passthrough Chargeback	4.1	0.0	0.0
5301 Inter-Agency Receipts	Admin - Administrative Services (46)	Microsoft and Adobe Passthrough Chargeback	0.6	0.0	0.0
5301 Inter-Agency Receipts	Admin - Alaska Public Offices Comm (70)	Microsoft and Adobe Passthrough Chargeback	1.1	0.0	0.0
5301 Inter-Agency Receipts	Admin - Finance (59)	Microsoft and Adobe Passthrough Chargeback	24.1	0.0	0.0
5301 Inter-Agency Receipts	Admin - Motor Vehicles (2348)	Microsoft and Adobe Passthrough Chargeback	38.7	0.0	0.0
5301 Inter-Agency Receipts	Admin - OFC of Procure. Property. Mngmt. (3291)	Microsoft and Adobe Passthrough Chargeback	0.7	0.0	0.0
5301 Inter-Agency Receipts	Admin - Office of Public Advocacy (43)	Microsoft and Adobe Passthrough Chargeback	2.7	0.0	0.0
5301 Inter-Agency Receipts	Admin - Office of the Commissioner (45)	Microsoft and Adobe Passthrough Chargeback	3.6	0.0	0.0
5301 Inter-Agency Receipts	Admin - Personnel (56)	Microsoft and Adobe Passthrough Chargeback	9.9	0.0	0.0
5301 Inter-Agency Receipts	Admin - Public Defender Agency (1631)	Microsoft and Adobe Passthrough Chargeback	22.1	0.0	0.0
5301 Inter-Agency Receipts	Admin - Retirement and Benefits (64)	Oracle settlement; Admin-DRB	37.5	0.0	0.0
5301 Inter-Agency Receipts	Admin - Risk Management (71)	Microsoft and Adobe Passthrough Chargeback	0.3	0.0	0.0
5301 Inter-Agency Receipts	Commerce - Department-wide	Microsoft and Adobe Passthrough Chargeback	98.3	0.0	0.0
5301 Inter-Agency Receipts	Correct - Department-wide	Microsoft and Adobe Passthrough Chargeback	134.1	0.0	0.0
5301 Inter-Agency Receipts	Courts - Department-wide	Microsoft and Adobe Passthrough Chargeback	1.2	0.0	0.0
5301 Inter-Agency Receipts	E&ED - Department-wide	Microsoft and Adobe Passthrough Chargeback	24.4	0.0	0.0
5301 Inter-Agency Receipts	EnvCon - Department-wide	Microsoft and Adobe Passthrough	41.6	0.0	0.0

Revenue Detail (1681)
Department of Administration

Component: Alaska Division of Information Technology (3141)

Revenue Type (OMB Fund Code) Revenue Source	Component	Comment	FY2022 Actuals	FY2023 Management Plan	FY2024 Governor
5301 Inter-Agency Receipts	FishGm - Department-wide	Chargeback Microsoft and Adobe Passthrough	209.6	0.0	0.0
5301 Inter-Agency Receipts	Gov - Department-wide	Chargeback Microsoft and Adobe Passthrough	58.5	0.0	0.0
5301 Inter-Agency Receipts	H&SS - Department-wide	Chargeback Microsoft and Adobe Passthrough	449.3	0.0	0.0
5301 Inter-Agency Receipts	Labor - Department-wide	Chargeback Microsoft and Adobe Passthrough	88.2	0.0	0.0
5301 Inter-Agency Receipts	Law - Department-wide	Chargeback Microsoft and Adobe Passthrough	60.7	0.0	0.0
5301 Inter-Agency Receipts	Legis - Department-wide	Chargeback Microsoft and Adobe Passthrough	22.7	0.0	0.0
5301 Inter-Agency Receipts	M&VA - Department-wide	Chargeback Microsoft and Adobe Passthrough	59.7	0.0	0.0
5301 Inter-Agency Receipts	NatRes - Department-wide	Chargeback Microsoft and Adobe Passthrough	94.3	0.0	0.0
5301 Inter-Agency Receipts	PubSaf - Department-wide	Chargeback Microsoft and Adobe Passthrough	172.6	0.0	0.0
5301 Inter-Agency Receipts	Rev - Department-wide	Chargeback Microsoft and Adobe Passthrough	271.3	0.0	0.0
5301 Inter-Agency Receipts	Trans - Department-wide	DOT Teamviewer (unbudgeted RSA)	367.0	0.0	0.0
5301 Inter-Agency Receipts	Admin - Finance (59)	Oracle Licensing RSA	702.5	0.0	0.0
5301 Inter-Agency Receipts	Gov - Department-wide	Central Services Cost Allocation	3,130.0	0.0	0.0
6081 Info Svc (1081 Info Svc)			52,561.0	61,572.6	83,913.8
6654 Information Services Fund Statutory Operating I/A Rec	Admin - Accounting (3134)	OIT Core Services (includes Adobe Pro and Microsoft 365 as well as services previously provided under the Telecommunications and Computer Services EPR)	2,677.1	232.3	343.3
6654 Information Services Fund Statutory Operating I/A Rec	Admin - Administrative Hearings (2771)	OIT Core Services (includes Adobe Pro and Microsoft 365 as well as services previously provided under the Telecommunications and Computer Services EPR)	0.0	53.5	77.1

Revenue Detail (1681)
Department of Administration

Component: Alaska Division of Information Technology (3141)

Revenue Type (OMB Fund Code) Revenue Source	Component	Comment	FY2022 Actuals	FY2023 Management Plan	FY2024 Governor
6654 Information Services Fund Statutory Operating I/A Rec	Admin - Administrative Services (46)	OIT Core Services (includes Adobe Pro and Microsoft 365 as well as services previously provided under the Telecommunications and Computer Services EPR)	0.0	33.1	47.7
6654 Information Services Fund Statutory Operating I/A Rec	Admin - Alaska Public Offices Comm (70)	OIT Core Services (includes Adobe Pro and Microsoft 365 as well as services previously provided under the Telecommunications and Computer Services EPR)	0.0	28.1	40.5
6654 Information Services Fund Statutory Operating I/A Rec	Admin - E-Travel (2966)	OIT Core Services (includes Adobe Pro and Microsoft 365 as well as services previously provided under the Telecommunications and Computer Services EPR)	0.0	3.2	3.2
6654 Information Services Fund Statutory Operating I/A Rec	Admin - Finance (59)	OIT Core Services (includes Adobe Pro and Microsoft 365 as well as services previously provided under the Telecommunications and Computer Services EPR)	0.0	312.2	450.0
6654 Information Services Fund Statutory Operating I/A Rec	Admin - Labor Relations (58)	OIT Core Services (includes Adobe Pro and Microsoft 365 as well as services previously provided under the Telecommunications and Computer Services EPR)	0.0	20.1	29.0
6654 Information Services Fund Statutory Operating I/A Rec	Admin - Motor Vehicles (2348)	OIT Core Services (includes Adobe Pro and Microsoft 365 as well as services previously provided under the Telecommunications and Computer Services EPR)	0.0	424.0	611.1
6654 Information Services Fund Statutory Operating I/A Rec	Admin - OFC of Procure. Property. Mngmt. (3291)	OIT Core Services (includes Adobe Pro and Microsoft 365 as well as services previously provided under the Telecommunications and Computer Services EPR)	0.0	50.6	72.9
6654 Information Services Fund Statutory Operating I/A Rec	Admin - Office of Public Advocacy (43)	OIT Core Services (includes Adobe Pro and Microsoft 365 as well as	0.0	628.3	905.5

Revenue Detail (1681)
Department of Administration

Component: Alaska Division of Information Technology (3141)

Revenue Type (OMB Fund Code) Revenue Source	Component	Comment	FY2022 Actuals	FY2023 Management Plan	FY2024 Governor
6654 Information Services Fund Statutory Operating I/A Rec	Admin - Office of the Commissioner (45)	services previously provided under the Telecommunications and Computer Services EPR) OIT Core Services (includes Adobe Pro and Microsoft 365 as well as services previously provided under the Telecommunications and Computer Services EPR)	0.0	20.7	29.8
6654 Information Services Fund Statutory Operating I/A Rec	Admin - Personnel (56)	OIT Core Services (includes Adobe Pro and Microsoft 365 as well as services previously provided under the Telecommunications and Computer Services EPR)	0.0	328.5	473.4
6654 Information Services Fund Statutory Operating I/A Rec	Admin - Print Services (2333)	OIT Core Services (includes Adobe Pro and Microsoft 365 as well as services previously provided under the Telecommunications and Computer Services EPR)	0.0	16.4	16.5
6654 Information Services Fund Statutory Operating I/A Rec	Admin - Public Defender Agency (1631)	OIT Core Services (includes Adobe Pro and Microsoft 365 as well as services previously provided under the Telecommunications and Computer Services EPR)	0.0	649.3	935.8
6654 Information Services Fund Statutory Operating I/A Rec	Admin - Retirement and Benefits (64)	OIT Core Services (includes Adobe Pro and Microsoft 365 as well as services previously provided under the Telecommunications and Computer Services EPR)	0.0	416.0	599.6
6654 Information Services Fund Statutory Operating I/A Rec	Admin - Risk Management (71)	OIT Core Services (includes Adobe Pro and Microsoft 365 as well as services previously provided under the Telecommunications and Computer Services EPR)	0.0	21.0	30.3
6654 Information Services Fund Statutory Operating I/A Rec	Commerce - Department-wide	OIT Core Services (includes Adobe Pro and Microsoft 365 as well as services previously provided under the Telecommunications and	1,215.3	1,471.0	2,120.0

Revenue Detail (1681)
Department of Administration

Component: Alaska Division of Information Technology (3141)

Revenue Type (OMB Fund Code) Revenue Source	Component	Comment	FY2022 Actuals	FY2023 Management Plan	FY2024 Governor
6654 Information Services Fund Statutory Operating I/A Rec	Correct - Department-wide	Computer Services (includes Adobe Pro and Microsoft 365 as well as services previously provided under the Telecommunications and Computer Services EPR)	4,059.9	4,902.9	7,066.2
6654 Information Services Fund Statutory Operating I/A Rec	Courts - Department-wide	OIT Core Services (includes Adobe Pro and Microsoft 365 as well as services previously provided under the Telecommunications and Computer Services EPR)	22.8	27.5	39.6
6654 Information Services Fund Statutory Operating I/A Rec	E&ED - Department-wide	OIT Core Services (includes Adobe Pro and Microsoft 365 as well as services previously provided under the Telecommunications and Computer Services EPR)	595.4	721.4	1,039.7
6654 Information Services Fund Statutory Operating I/A Rec	EnvCon - Department-wide	OIT Core Services (includes Adobe Pro and Microsoft 365 as well as services previously provided under the Telecommunications and Computer Services EPR)	1,260.1	1,525.2	2,198.2
6654 Information Services Fund Statutory Operating I/A Rec	FCS - Department-wide	OIT Core Services (includes Adobe Pro and Microsoft 365 as well as services previously provided under the Telecommunications and Computer Services EPR)	0.0	6,070.1	8,749.5
6654 Information Services Fund Statutory Operating I/A Rec	FishGm - Department-wide	OIT Core Services (includes Adobe Pro and Microsoft 365 as well as services previously provided under the Telecommunications and Computer Services EPR)	2,966.0	3,590.2	5,174.2
6654 Information Services Fund Statutory Operating I/A Rec	Gov - Department-wide	OIT Core Services (includes Adobe Pro and Microsoft 365 as well as services previously provided under the Telecommunications and Computer Services EPR)	299.1	361.1	520.8
6654 Information Services Fund Statutory	H&SS - Department-wide	OIT Core Services (includes Adobe Pro and Microsoft 365 as well as services previously provided under the Telecommunications and Computer Services EPR)	9,710.7	0.0	0.0

Revenue Detail (1681)
Department of Administration

Component: Alaska Division of Information Technology (3141)

Revenue Type (OMB Fund Code) Revenue Source	Component	Comment	FY2022 Actuals	FY2023 Management Plan	FY2024 Governor
Operating I/A Rec		Pro and Microsoft 365 as well as services previously provided under the Telecommunications and Computer Services EPR)			
6654 Information Services Fund Statutory Operating I/A Rec	Health - Department-wide	OIT Core Services (includes Adobe Pro and Microsoft 365 as well as services previously provided under the Telecommunications and Computer Services EPR)	0.0	5,170.8	7,452.3
6654 Information Services Fund Statutory Operating I/A Rec	Labor - Department-wide	OIT Core Services (includes Adobe Pro and Microsoft 365 as well as services previously provided under the Telecommunications and Computer Services EPR)	1,685.2	2,039.8	2,939.8
6654 Information Services Fund Statutory Operating I/A Rec	Law - Department-wide	OIT Core Services (includes Adobe Pro and Microsoft 365 as well as services previously provided under the Telecommunications and Computer Services EPR)	1,421.4	1,720.5	2,479.6
6654 Information Services Fund Statutory Operating I/A Rec	Legis - Department-wide	OIT Core Services (includes Adobe Pro and Microsoft 365 as well as services previously provided under the Telecommunications and Computer Services EPR)	294.0	355.8	512.7
6654 Information Services Fund Statutory Operating I/A Rec	M&VA - Department-wide	OIT Core Services (includes Adobe Pro and Microsoft 365 as well as services previously provided under the Telecommunications and Computer Services EPR)	644.1	779.5	1,123.5
6654 Information Services Fund Statutory Operating I/A Rec	NatRes - Department-wide	OIT Core Services (includes Adobe Pro and Microsoft 365 as well as services previously provided under the Telecommunications and Computer Services EPR)	2,355.0	2,850.6	4,108.3
6654 Information Services Fund Statutory Operating I/A Rec	PubSaf - Department-wide	OIT Core Services (includes Adobe Pro and Microsoft 365 as well as services previously provided under	2,286.9	2,768.1	3,989.4

Revenue Detail (1681)
Department of Administration

Component: Alaska Division of Information Technology (3141)

Revenue Type (OMB Fund Code) Revenue Source	Component	Comment	FY2022 Actuals	FY2023 Management Plan	FY2024 Governor
6654 Information Services Fund Statutory Operating I/A Rec	Rev - Department-wide	the Telecommunications and Computer Services EPR) OIT Core Services (includes Adobe Pro and Microsoft 365 as well as services previously provided under the Telecommunications and Computer Services EPR)	1,221.4	1,478.4	2,130.6
6654 Information Services Fund Statutory Operating I/A Rec	Trans - Department-wide	OIT Core Services (includes Adobe Pro and Microsoft 365 as well as services previously provided under the Telecommunications and Computer Services EPR)	5,598.2	6,778.8	9,769.7
6654 Information Services Fund Statutory Operating I/A Rec	Admin - Accounting (3134)	OIT Telecommunications (CISCO device config, deployment, maintenance, and replacements)	268.5	301.1	314.6
6654 Information Services Fund Statutory Operating I/A Rec	Admin - Administrative Hearings (2771)	OIT Telecommunications (CISCO device config, deployment, maintenance, and replacements)	0.0	0.0	0.0
6654 Information Services Fund Statutory Operating I/A Rec	Admin - Administrative Services (46)	OIT Telecommunications (CISCO device config, deployment, maintenance, and replacements)	0.0	0.0	0.0
6654 Information Services Fund Statutory Operating I/A Rec	Admin - Alaska Public Offices Comm (70)	OIT Telecommunications (CISCO device config, deployment, maintenance, and replacements)	0.0	0.0	0.0
6654 Information Services Fund Statutory Operating I/A Rec	Admin - Finance (59)	OIT Telecommunications (CISCO device config, deployment, maintenance, and replacements)	0.0	0.0	0.0
6654 Information Services Fund Statutory Operating I/A Rec	Admin - Labor Relations (58)	OIT Telecommunications (CISCO device config, deployment, maintenance, and replacements)	0.0	0.0	0.0
6654 Information Services Fund Statutory Operating I/A Rec	Admin - Motor Vehicles (2348)	OIT Telecommunications (CISCO device config, deployment, maintenance, and replacements)	0.0	0.0	0.0
6654 Information Services Fund Statutory Operating I/A Rec	Admin - Office of Public Advocacy (43)	OIT Telecommunications (CISCO device config, deployment, maintenance, and replacements)	0.0	0.0	0.0
6654 Information Services Fund Statutory	Admin - Office of the Commissioner	OIT Telecommunications (CISCO	0.0	0.0	0.0

Revenue Detail (1681)
Department of Administration

Component: Alaska Division of Information Technology (3141)

Revenue Type (OMB Fund Code) Revenue Source	Component	Comment	FY2022 Actuals	FY2023 Management Plan	FY2024 Governor
Operating I/A Rec	(45)	device config, deployment, maintenance, and replacements)			
6654 Information Services Fund Statutory Operating I/A Rec	Admin - Personnel (56)	OIT Telecommunications (CISCO device config, deployment, maintenance, and replacements)	0.0	0.0	0.0
6654 Information Services Fund Statutory Operating I/A Rec	Admin - Print Services (2333)	OIT Telecommunications (CISCO device config, deployment, maintenance, and replacements)	0.0	0.0	0.0
6654 Information Services Fund Statutory Operating I/A Rec	Admin - Public Defender Agency (1631)	OIT Telecommunications (CISCO device config, deployment, maintenance, and replacements)	0.0	0.0	0.0
6654 Information Services Fund Statutory Operating I/A Rec	Admin - Retirement and Benefits (64)	OIT Telecommunications (CISCO device config, deployment, maintenance, and replacements)	0.0	0.0	0.0
6654 Information Services Fund Statutory Operating I/A Rec	Admin - Risk Management (71)	OIT Telecommunications (CISCO device config, deployment, maintenance, and replacements)	0.0	0.0	0.0
6654 Information Services Fund Statutory Operating I/A Rec	Commerce - Department-wide	OIT Telecommunications (CISCO device config, deployment, maintenance, and replacements)	138.3	137.0	143.2
6654 Information Services Fund Statutory Operating I/A Rec	Correct - Department-wide	OIT Telecommunications (CISCO device config, deployment, maintenance, and replacements)	245.1	244.4	255.4
6654 Information Services Fund Statutory Operating I/A Rec	E&ED - Department-wide	OIT Telecommunications (CISCO device config, deployment, maintenance, and replacements)	74.4	74.7	78.1
6654 Information Services Fund Statutory Operating I/A Rec	EnvCon - Department-wide	OIT Telecommunications (CISCO device config, deployment, maintenance, and replacements)	157.5	158.0	165.1
6654 Information Services Fund Statutory Operating I/A Rec	FCS - Department-wide	OIT Telecommunications (CISCO device config, deployment, maintenance, and replacements)	0.0	368.5	386.1
6654 Information Services Fund Statutory Operating I/A Rec	FishGm - Department-wide	OIT Telecommunications (CISCO device config, deployment, maintenance, and replacements)	210.6	214.7	224.4
6654 Information Services Fund Statutory Operating I/A Rec	Gov - Department-wide	OIT Telecommunications (CISCO device config, deployment,	77.5	78.0	81.5

Revenue Detail (1681)
Department of Administration

Component: Alaska Division of Information Technology (3141)

Revenue Type (OMB Fund Code) Revenue Source	Component	Comment	FY2022 Actuals	FY2023 Management Plan	FY2024 Governor
6654 Information Services Fund Statutory Operating I/A Rec	H&SS - Department-wide	maintenance, and replacements) OIT Telecommunications (CISCO device config, deployment, maintenance, and replacements)	897.0	0.0	0.0
6654 Information Services Fund Statutory Operating I/A Rec	Health - Department-wide	OIT Telecommunications (CISCO device config, deployment, maintenance, and replacements)	0.0	518.4	542.9
6654 Information Services Fund Statutory Operating I/A Rec	Labor - Department-wide	OIT Telecommunications (CISCO device config, deployment, maintenance, and replacements)	238.0	234.9	245.5
6654 Information Services Fund Statutory Operating I/A Rec	Law - Department-wide	OIT Telecommunications (CISCO device config, deployment, maintenance, and replacements)	155.9	159.4	166.6
6654 Information Services Fund Statutory Operating I/A Rec	Legis - Department-wide	OIT Telecommunications (CISCO device config, deployment, maintenance, and replacements)	205.4	207.5	216.8
6654 Information Services Fund Statutory Operating I/A Rec	M&VA - Department-wide	OIT Telecommunications (CISCO device config, deployment, maintenance, and replacements)	106.3	106.2	111.0
6654 Information Services Fund Statutory Operating I/A Rec	NatRes - Department-wide	OIT Telecommunications (CISCO device config, deployment, maintenance, and replacements)	214.2	210.3	219.8
6654 Information Services Fund Statutory Operating I/A Rec	PubSaf - Department-wide	OIT Telecommunications (CISCO device config, deployment, maintenance, and replacements)	168.7	171.7	179.4
6654 Information Services Fund Statutory Operating I/A Rec	Rev - Department-wide	OIT Telecommunications (CISCO device config, deployment, maintenance, and replacements)	162.1	106.0	110.8
6654 Information Services Fund Statutory Operating I/A Rec	Trans - Department-wide	OIT Telecommunications (CISCO device config, deployment, maintenance, and replacements)	474.0	476.7	499.2
6654 Information Services Fund Statutory Operating I/A Rec	Admin - Accounting (3134)	OIT Server Hosting and Storage	903.7	10.1	15.6
6654 Information Services Fund Statutory Operating I/A Rec	Admin - Administrative Hearings (2771)	OIT Server Hosting and Storage	0.0	3.6	5.5
6654 Information Services Fund Statutory Operating I/A Rec	Admin - Alaska Public Offices Comm (70)	OIT Server Hosting and Storage	0.0	0.0	0.0

Revenue Detail (1681)
Department of Administration

Component: Alaska Division of Information Technology (3141)

Revenue Type (OMB Fund Code) Revenue Source	Component	Comment	FY2022 Actuals	FY2023 Management Plan	FY2024 Governor
6654 Information Services Fund Statutory Operating I/A Rec	Admin - Finance (59)	OIT Server Hosting and Storage	0.0	528.8	811.5
6654 Information Services Fund Statutory Operating I/A Rec	Admin - Motor Vehicles (2348)	OIT Server Hosting and Storage	0.0	172.1	266.0
6654 Information Services Fund Statutory Operating I/A Rec	Admin - Office of Public Advocacy (43)	OIT Server Hosting and Storage	0.0	15.8	24.3
6654 Information Services Fund Statutory Operating I/A Rec	Admin - Personnel (56)	OIT Server Hosting and Storage	0.0	12.8	19.7
6654 Information Services Fund Statutory Operating I/A Rec	Admin - Print Services (2333)	OIT Server Hosting and Storage	0.0	0.0	0.0
6654 Information Services Fund Statutory Operating I/A Rec	Admin - Public Defender Agency (1631)	OIT Server Hosting and Storage	0.0	33.9	52.2
6654 Information Services Fund Statutory Operating I/A Rec	Admin - Retirement and Benefits (64)	OIT Server Hosting and Storage	0.0	121.0	183.3
6654 Information Services Fund Statutory Operating I/A Rec	Admin - Risk Management (71)	OIT Server Hosting and Storage	0.0	0.0	0.0
6654 Information Services Fund Statutory Operating I/A Rec	Commerce - Department-wide	OIT Server Hosting and Storage	116.2	123.9	190.8
6654 Information Services Fund Statutory Operating I/A Rec	Correct - Department-wide	OIT Server Hosting and Storage	283.7	253.8	390.9
6654 Information Services Fund Statutory Operating I/A Rec	E&ED - Department-wide	OIT Server Hosting and Storage	155.5	96.1	148.0
6654 Information Services Fund Statutory Operating I/A Rec	EnvCon - Department-wide	OIT Server Hosting and Storage	332.8	293.9	450.6
6654 Information Services Fund Statutory Operating I/A Rec	FishGm - Department-wide	OIT Server Hosting and Storage	514.5	510.9	783.8
6654 Information Services Fund Statutory Operating I/A Rec	Gov - Department-wide	OIT Server Hosting and Storage	19.7	19.6	30.2
6654 Information Services Fund Statutory Operating I/A Rec	H&SS - Department-wide	OIT Server Hosting and Storage	408.9	0.0	0.0
6654 Information Services Fund Statutory Operating I/A Rec	Health - Department-wide	OIT Server Hosting and Storage	0.0	431.6	661.7
6654 Information Services Fund Statutory Operating I/A Rec	Labor - Department-wide	OIT Server Hosting and Storage	14.5	14.4	22.2
6654 Information Services Fund Statutory Operating I/A Rec	Law - Department-wide	OIT Server Hosting and Storage	507.3	584.0	892.4
6654 Information Services Fund Statutory	Legis - Department-wide	OIT Server Hosting and Storage	14.5	14.4	22.2

Revenue Detail (1681)
Department of Administration

Component: Alaska Division of Information Technology (3141)

Revenue Type (OMB Fund Code) Revenue Source	Component	Comment	FY2022 Actuals	FY2023 Management Plan	FY2024 Governor
Operating I/A Rec 6654 Information Services Fund Statutory	M&VA - Department-wide	OIT Server Hosting and Storage	154.3	121.0	186.3
Operating I/A Rec 6654 Information Services Fund Statutory	NatRes - Department-wide	OIT Server Hosting and Storage	342.1	291.6	448.0
Operating I/A Rec 6654 Information Services Fund Statutory	PubSaf - Department-wide	OIT Server Hosting and Storage	390.8	384.8	590.0
Operating I/A Rec 6654 Information Services Fund Statutory	Rev - Department-wide	OIT Server Hosting and Storage	465.2	459.8	706.0
Operating I/A Rec 6654 Information Services Fund Statutory	Trans - Department-wide	OIT Server Hosting and Storage	169.2	162.5	250.3
Operating I/A Rec 6654 Information Services Fund Statutory	Admin - Finance (59)	OIT MICS (Mainframe Usage)	58.7	132.7	122.4
Operating I/A Rec 6654 Information Services Fund Statutory	Admin - Motor Vehicles (2348)	OIT MICS (Mainframe Usage)	0.0	0.0	0.0
Operating I/A Rec 6654 Information Services Fund Statutory	Admin - Office of Public Advocacy (43)	OIT MICS (Mainframe Usage)	0.0	0.0	0.0
Operating I/A Rec 6654 Information Services Fund Statutory	Admin - Personnel (56)	OIT MICS (Mainframe Usage)	0.0	0.0	0.0
Operating I/A Rec 6654 Information Services Fund Statutory	Admin - Retirement and Benefits (64)	OIT MICS (Mainframe Usage)	0.0	0.0	0.0
Operating I/A Rec 6654 Information Services Fund Statutory	Commerce - Department-wide	OIT SQL	0.0	0.0	0.0
Operating I/A Rec 6654 Information Services Fund Statutory	Correct - Department-wide	OIT MICS (Mainframe Usage)	2.6	5.9	5.5
Operating I/A Rec 6654 Information Services Fund Statutory	E&ED - Department-wide	OIT MICS (Mainframe Usage)	7.2	17.3	16.0
Operating I/A Rec 6654 Information Services Fund Statutory	EnvCon - Department-wide	OIT SQL	0.0	0.0	0.0
Operating I/A Rec 6654 Information Services Fund Statutory	FCS - Department-wide	OIT MICS (Mainframe Usage)	0.0	62.4	57.6
Operating I/A Rec 6654 Information Services Fund Statutory	FishGm - Department-wide	OIT SQL	0.0	0.0	0.0
Operating I/A Rec 6654 Information Services Fund Statutory	Gov - Department-wide	OIT MICS (Mainframe Usage)	0.0	0.5	0.5
Operating I/A Rec 6654 Information Services Fund Statutory	H&SS - Department-wide	OIT MICS (Mainframe Usage)	1,314.7	0.0	0.0

Revenue Detail (1681)
Department of Administration

Component: Alaska Division of Information Technology (3141)

Revenue Type (OMB Fund Code) Revenue Source	Component	Comment	FY2022 Actuals	FY2023 Management Plan	FY2024 Governor
6654 Information Services Fund Statutory Operating I/A Rec	Health - Department-wide	OIT MICS (Mainframe Usage)	0.0	2,635.1	2,430.9
6654 Information Services Fund Statutory Operating I/A Rec	Labor - Department-wide	OIT MICS (Mainframe Usage)	13.5	17.8	16.4
6654 Information Services Fund Statutory Operating I/A Rec	Law - Department-wide	OIT MICS (Mainframe Usage)	1.9	4.0	3.7
6654 Information Services Fund Statutory Operating I/A Rec	Legis - Department-wide	OIT MICS (Mainframe Usage)	0.8	1.6	1.5
6654 Information Services Fund Statutory Operating I/A Rec	M&VA - Department-wide	OIT SQL	0.0	0.0	0.0
6654 Information Services Fund Statutory Operating I/A Rec	NatRes - Department-wide	OIT MICS (Mainframe Usage)	175.0	337.5	311.2
6654 Information Services Fund Statutory Operating I/A Rec	PubSaf - Department-wide	OIT MICS (Mainframe Usage)	1,001.6	1,804.1	1,664.0
6654 Information Services Fund Statutory Operating I/A Rec	Rev - Department-wide	OIT MICS (Mainframe Usage); reduced as CSSD moved off mainframe in FY21	19.7	45.4	41.9
6654 Information Services Fund Statutory Operating I/A Rec	Trans - Department-wide	OIT MICS (Mainframe Usage)	6.8	14.6	13.5
6654 Information Services Fund Statutory Operating I/A Rec	Admin - Finance (59)	OIT SQL	35.1	22.0	22.9
6654 Information Services Fund Statutory Operating I/A Rec	Admin - Motor Vehicles (2348)	OIT SQL	0.0	0.0	0.0
6654 Information Services Fund Statutory Operating I/A Rec	Admin - Retirement and Benefits (64)	OIT SQL	0.0	0.0	0.0
6654 Information Services Fund Statutory Operating I/A Rec	Commerce - Department-wide	OIT SQL	125.2	106.1	110.5
6654 Information Services Fund Statutory Operating I/A Rec	Correct - Department-wide	OIT SQL	106.7	106.9	111.4
6654 Information Services Fund Statutory Operating I/A Rec	EnvCon - Department-wide	OIT SQL	54.6	66.3	69.1
6654 Information Services Fund Statutory Operating I/A Rec	FishGm - Department-wide	OIT SQL	182.9	187.1	194.8
6654 Information Services Fund Statutory Operating I/A Rec	Law - Department-wide	OIT SQL	35.1	35.1	36.6
6654 Information Services Fund Statutory Operating I/A Rec	M&VA - Department-wide	OIT SQL	0.0	15.6	16.2

Revenue Detail (1681)
Department of Administration

Component: Alaska Division of Information Technology (3141)

Revenue Type (OMB Fund Code) Revenue Source	Component	Comment	FY2022 Actuals	FY2023 Management Plan	FY2024 Governor
6654 Information Services Fund Statutory Operating I/A Rec	NatRes - Department-wide	OIT SQL	31.3	31.2	32.4
6654 Information Services Fund Statutory Operating I/A Rec	PubSaf - Department-wide	OIT SQL	122.7	122.7	127.8
6654 Information Services Fund Statutory Operating I/A Rec	Rev - Department-wide	OIT SQL	179.3	179.3	186.7
6654 Information Services Fund Statutory Operating I/A Rec		FOIA (Freedom of Information Act) collections; DOT AMHS circuit; Misc revenue and refunds	7.9	0.0	0.0
6654 Information Services Fund Statutory Operating I/A Rec	NatRes - Department-wide	OIT Line of Business costs	1,168.0	340.0	0.0
6654 Information Services Fund Statutory Operating I/A Rec	Admin - Accounting (3134)	OIT Oracle costs	801.2	800.0	914.8
6654 Information Services Fund Statutory Operating I/A Rec	FishGm - Department-wide	OIT Oracle costs	163.8	163.0	186.4
6654 Information Services Fund Statutory Operating I/A Rec	NatRes - Department-wide	OIT Oracle costs	41.6	41.5	47.4
6658 Information Services Fund - Prior Year Reimburse Recovery		Refunds; Prior year recovery of outstanding chargeback rates	4.1	0.0	0.0
6658 Information Services Fund - Prior Year Reimburse Recovery	Admin - Office of Public Advocacy (43)	Ticket exchange transaction with Office of Public Advocacy	0.0	0.0	0.0
6658 Information Services Fund - Prior Year Reimburse Recovery	M&VA - Department-wide	OIT Adobe Passthrough	0.0	0.0	0.0

Inter-Agency Services (1682)
Department of Administration

Component: Alaska Division of Information Technology (3141)

				FY2022 Actuals	FY2023 Management Plan	FY2024 Governor
Component Totals				2,247.9	2,724.0	2,654.4
With Department of Administration				1,343.3	1,436.7	1,403.3
With Department of Natural Resources				10.7	25.0	25.0
With Department of Transportation/Public Facilities				859.7	1,222.3	1,226.1
With Department of Fish and Game				34.2	40.0	0.0
Object Class	Servicing Agency	Explanation		FY2022 Actuals	FY2023 Management Plan	FY2024 Governor
3020	Inter-Agency Building Maintenance	NatRes - Department-wide	Building maintenance services	10.7	25.0	25.0
3021	Inter-Agency Mail	Admin - Print Services (2333)	Centralized mail services chargeback	2.3	4.1	4.5
3022	Inter-Agency Human Resources	Admin - Personnel (56)	Human resource chargeback and payroll services provided by the Division of Personnel	158.1	135.0	135.5
3023	Inter-Agency Building Leases	Trans - Department-wide	Rent for state-owned facilities and lease payments	764.3	1,106.4	1,110.6
3026	Inter-Agency Insurance	Admin - Risk Management (71)	Division of Risk Management - Risk management insurance charges	14.2	29.2	29.2
3027	Inter-Agency Financial	Admin - Accounting (3134)	SSoA Accounts Payable and Travel Chargeback	99.1	99.0	99.0
3027	Inter-Agency Financial	Admin - Finance (59)	Division of Finance Chargeback for IRIS FIN, HRM, and ALDER	11.6	20.0	20.0
3028	Inter-Agency Americans with Disabilities Act Compliance	Admin - Personnel (56)	Americans with Disabilities Act (ADA) Chargeback	2.1	2.1	2.1
3037	State Equipment Fleet	Trans - Department-wide	State equipment fleet chargeback for vehicle lease, maintenance, and fuel	12.4	9.9	9.5
3038	Inter-Agency Management/Consulting	Admin - Administrative Services (46)	Support services provided by the Division of Administrative Services Chargeback	733.6	381.4	381.4
3038	Inter-Agency Management/Consulting	Admin - OFC of Procure. Property. Mngmt. (3291)	SSoA Procurement Chargeback	322.3	350.0	350.0
FY2024 Governor Department of Administration				Released December 15, 2022 Page 31		

Inter-Agency Services (1682)
Department of Administration

Component: Alaska Division of Information Technology (3141)

Object Class	Servicing Agency	Explanation	FY2022 Actuals	FY2023 Management Plan	FY2024 Governor
3038 Inter-Agency Management/Consulting	Admin - Office of the Commissioner (45)	Support services provided by the Office of the Commissioner	0.0	415.9	381.6
3038 Inter-Agency Management/Consulting	FishGm - Department-wide	DFG Acting DTO	34.2	40.0	0.0
3038 Inter-Agency Management/Consulting	Trans - Department-wide	Electrical consumption costs	83.0	106.0	106.0

Personal Services Expenditure Detail
Department of Administration

Scenario: FY2024 Governor (19867)
Component: Alaska Division of Information Technology (3141)
RDU: Office of Information Technology (653)

PCN	Job Class Title	Time Status	Retire Code	Barg Unit	Location	Salary Sched	Range / Step	Comp Months	Split / Count	Annual Salaries	COLA	Premium Pay	Annual Benefits	Total Costs	UGF Amount
02-0013	Systems Programmer 2	FT	N	GP	Anchorage	200	22K	12.0		107,055	3,087	2,780	32,640	145,562	0
02-1035	Internet Specialist 2	FT	A	GP	Juneau	205	19G / J	12.0		86,842	2,986	0	51,582	141,410	0
02-1048	Administrative Officer 2	FT	A	GP	Anchorage	200	19K	12.0		87,282	3,001	0	51,747	142,030	0
02-1105	Micro/Net Sp 2	FT	A	GP	Anchorage	200	20C / D	12.0		77,273	2,743	2,500	48,929	131,445	0
02-1155	Micro/Net Sp 1	FT	A	GP	Juneau	205	18N	12.0		94,419	3,450	5,932	56,650	160,451	0
02-1534	Micro/Net Sp 1	FT	A	GP	Anchorage	200	18K / L	12.0		83,785	2,881	0	50,435	137,101	0
02-2095	Micro/Net Sp 2	FT	A	SS	Juneau	99	20O	12.0		116,631	1,791	13,632	70,547	202,601	0
02-3001	Dep Chf Inf Ofc	FT	A	XE	Anchorage	N00	27V / W	12.0		199,145	0	0	93,860	293,005	0
02-3005	Administrative Assistant 3	FT	A	SS	Juneau	605	15J / K	12.0		69,569	1,001	3,226	48,985	122,781	0
02-3006	Program Coordinator 2	FT	A	SS	Juneau	205	20F	12.0		94,390	1,298	0	57,088	152,776	0
02-3019	Data Processing Manager 1	FT	A	SS	Anchorage	200	22C	12.0		92,622	1,280	432	56,586	150,920	0
02-3054	Accountant 4	FT	A	SS	Juneau	205	20E / F	12.0		93,253	1,282	0	56,661	151,196	0
02-3080	DPT Tech Ofc 3	FT	A	SS	Juneau	205	25F	12.0		132,662	1,830	432	71,609	206,533	0
02-3086	Accounting Technician 1	FT	A	GP	Juneau	205	12C / D	12.0		46,929	1,686	2,125	37,404	88,144	0
02-3108	Systems Programmer 3	FT	A	SS	Anchorage	99	23O	12.0		135,936	1,944	5,432	74,714	218,026	0
02-3109	Data Comm Sp 2	FT	A	GP	Fairbanks	203	21G / J	12.0		97,695	3,397	1,100	56,067	158,259	0
02-3111	Data Comm Sp 2	FT	A	GP	Fairbanks	203	21C / D	12.0		86,613	3,012	1,000	51,871	142,496	0
02-3112	Data Comm Sp 2	FT	A	GP	Anchorage	200	21F / G	12.0		92,575	3,224	1,200	54,183	151,182	0
02-3113	Systems Programmer 2	FT	A	GP	Juneau	205	22M / N	12.0		122,253	4,203	0	64,868	191,324	0
02-3114	Systems Programmer 2	FT	A	GP	Juneau	205	22M / N	12.0		119,989	4,250	3,632	65,381	193,252	0
02-3115	Accounting Technician 2	FT	A	GP	Juneau	205	14C	12.0		52,650	1,862	1,498	39,315	95,325	0
02-3117	Systems Programmer 2	FT	A	GP	Juneau	205	22J / K	12.0		111,235	3,852	800	61,034	176,921	0
02-3120	Data Processing Manager 2	FT	A	SS	Anchorage	200	23L	12.0		121,118	1,706	2,932	68,216	193,972	0
02-3122	DPT Tech Ofc 2	FT	A	SS	Anchorage	200	24L	12.0		139,057	1,912	0	73,847	214,816	0
02-5148	Systems Programmer 1	FT	A	GG	Juneau	205	20M / N	12.0		107,079	3,817	3,932	60,650	175,478	0
02-5174	Chief Technology Officer 3	FT	A	XE	Juneau	N05	26Q	12.0		168,734	0	0	84,314	253,048	0
02-6300	Staff Manager, Oit	FT	A	XE	Anchorage	N00	25T / U	12.0		174,274	0	0	86,053	260,327	0
02-6301	Data Processing Manager 3	FT	A	SS	Anchorage	200	24E / F	12.0		115,946	1,594	0	65,176	182,716	0
02-6304	Systems Programmer 2	FT	A	GP	Anchorage	200	22J / K	12.0		106,352	3,792	3,932	60,377	174,453	0
02-6307	Accountant 5	FT	A	SS	Juneau	205	22E / F	12.0		106,870	1,470	0	61,770	170,110	0
02-6308	Office Assistant 2	FT	A	GP	Anchorage	200	10A	12.0		36,621	1,307	1,408	33,267	72,603	0
02-6312	Systems Programmer 2	FT	A	GP	Anchorage	200	22G / J	12.0		102,993	3,644	3,000	58,767	168,404	0
02-6314	Database Specialist 3	FT	A	GP	Juneau	205	22E / F	12.0		98,608	3,842	13,132	60,923	176,505	0
02-6316	Accountant 2	FT	A	GP	Juneau	205	16E / F	12.0		66,116	2,273	0	43,805	112,194	0
02-6400	Chief Technology Officer 3	FT	A	XE	Juneau	N05	26S / T	12.0		184,534	0	432	89,410	274,376	0
02-6401	Data Processing Manager 3	FT	A	SS	Anchorage	99	24O	12.0		143,782	1,983	432	75,782	221,979	0
02-6402	Administrative Assistant 3	FT	A	GP	Juneau	205	15C / D	12.0		57,112	2,038	2,175	41,243	102,568	0
02-6404	Database Specialist 2	FT	A	GP	Anchorage	200	21A / B	12.0		77,831	2,848	5,000	50,077	135,756	0

Note: If a position is split, an asterisk (*) will appear in the Split/Count column. If the split position is also counted in the component, two asterisks (**) will appear in this column. [No valid job title] appearing in the Job Class Title indicates that the PCN has an invalid class code or invalid range for the class code effective date of this scenario.

Personal Services Expenditure Detail
Department of Administration

Scenario: FY2024 Governor (19867)
Component: Alaska Division of Information Technology (3141)
RDU: Office of Information Technology (653)

PCN	Job Class Title	Time Status	Retire Code	Barg Unit	Location	Salary Sched	Range / Step	Comp Months	Split / Count	Annual Salaries	COLA	Premium Pay	Annual Benefits	Total Costs	UGF Amount
02-6408	Systems Programmer 3	FT	A	SS	Anchorage	200	23L	12.0		121,118	1,768	7,432	69,905	200,223	0
02-6415	Systems Programmer 2	FT	A	GP	Anchorage	200	22A / B	12.0		83,012	2,926	2,100	50,933	138,971	0
02-6417	Systems Programmer 3	FT	A	SS	Juneau	99	23J	12.0		127,442	1,891	10,032	73,253	212,618	0
02-6418	Systems Programmer 2	FT	A	GP	Juneau	99	22Q / R	12.0		141,804	5,064	5,500	74,267	226,635	0
02-6501	Data Processing Manager 1	FT	A	SS	Anchorage	200	22E / F	12.0		115,116	1,624	3,000	65,990	185,730	0
02-6502	Systems Programmer 2	FT	A	GP	Anchorage	200	22G / J	12.0		103,303	3,627	2,200	58,583	167,713	0
02-6504	Tech Arch Spec	FT	A	GP	Juneau	205	24F / G	12.0		118,220	4,064	0	63,355	185,639	0
02-6505	Systems Programmer 3	FT	A	GP	Anchorage	99	23P	12.0		136,064	4,867	5,500	72,113	218,544	0
02-6506	Systems Programmer 3	FT	A	GP	Juneau	99	23O / P	12.0		145,528	5,218	6,232	75,939	232,917	0
02-6507	Data Processing Manager 1	FT	A	SS	Anchorage	200	22O	12.0		124,384	1,755	3,200	69,542	198,881	0
02-6508	Data Comm Sp 2	FT	A	GP	Juneau	205	21A / B	12.0		81,164	2,854	1,849	50,145	136,012	0
02-6509	Data Comm Sp 1	FT	A	GP	Anchorage	200	19C	12.0		71,019	2,493	1,500	46,208	121,220	0
02-6510	Data Comm Sp 1	FT	A	GP	Anchorage	200	19C	12.0		71,019	2,490	1,400	46,170	121,079	0
02-6511	Systems Programmer 3	FT	A	GP	Anchorage	200	23C	12.0		92,898	3,432	6,932	56,455	159,717	0
02-6513	Systems Programmer 3	FT	A	SS	Anchorage	200	23M	12.0		125,050	1,781	4,432	70,254	201,517	0
02-6514	Systems Programmer 3	FT	A	GP	Anchorage	99	23O	12.0		134,430	4,811	5,500	71,500	216,241	0
02-6516	Program Coordinator 2	FT	A	GP	Juneau	205	20E / F	12.0		87,269	3,000	0	51,742	142,011	0
02-6518	Data Comm Sp 2	FT	A	GP	Anchorage	200	21J / K	12.0		98,760	3,484	2,581	57,022	161,847	0
02-6522	Data Comm Sp 1	FT	A	GP	Fairbanks	203	19A / B	12.0		70,170	2,476	1,847	46,019	120,512	0
02-6523	Systems Programmer 2	FT	A	GP	Anchorage	200	22G	12.0		99,548	3,543	3,500	57,662	164,253	0
02-6524	Data Comm Sp 2	FT	A	GP	Anchorage	200	21D / E	12.0		84,543	2,973	1,932	51,444	140,892	0
02-6527	Systems Programmer 3	FT	A	GP	Ketchikan	200	23L / M	12.0		120,471	4,217	2,200	65,025	191,913	0
02-6529	Systems Programmer 2	FT	A	GP	Juneau	205	22F / G	12.0		103,028	3,714	5,000	59,531	171,273	0
02-6601	Data Processing Manager 3	FT	A	SS	Anchorage	200	24Q	12.0		151,861	2,088	0	78,651	232,600	0
02-6605	Systems Programmer 4	FT	A	SS	Anchorage	200	25M	12.0		143,562	2,049	5,432	77,575	228,618	0
02-6607	Database Specialist 1	FT	A	GP	Anchorage	200	20C	12.0		75,972	2,945	9,700	51,143	139,760	0
02-6610	Systems Programmer 2	FT	A	GP	Juneau	205	22L / M	12.0		119,512	4,226	3,400	65,115	192,253	0
02-6612	Systems Programmer 1	FT	A	GP	Juneau	205	20J / K	12.0		97,770	3,746	11,195	59,882	172,593	0
02-6614	DP Prod Mgr	FT	A	SS	Juneau	205	19M / N	12.0		102,586	1,547	9,932	63,889	177,954	0
02-6616	Micro/Net Tc 2	FT	A	GP	Anchorage	200	16A / B	12.0		55,616	1,976	1,864	40,565	100,021	0
02-6617	Analyst/Programmer 5	FT	A	GP	Juneau	205	22K / L	12.0		113,747	4,118	6,032	63,940	187,837	0
02-6621	Database Specialist 3	FT	A	SS	Juneau	205	22E	12.0		104,062	1,569	10,032	64,481	180,144	0
02-6624	Data Processing Technician 2	FT	A	SS	Anchorage	200	15M / N	12.0		74,719	1,112	6,127	52,006	133,964	0
02-6639	Data Processing Technician 2	FT	A	GP	Juneau	205	15M	12.0		74,646	2,789	6,476	49,436	133,347	0
02-6640	Data Processing Technician 2	FT	A	GP	Juneau	205	15G / J	12.0		65,372	2,425	5,149	45,458	118,404	0
02-6641	Data Processing Technician	FT	A	GP	Anchorage	200	15J / K	12.0		64,935	2,280	1,396	43,886	112,497	0

Note: If a position is split, an asterisk (*) will appear in the Split/Count column. If the split position is also counted in the component, two asterisks (**) will appear in this column. [No valid job title] appearing in the Job Class Title indicates that the PCN has an invalid class code or invalid range for the class code effective date of this scenario.

Personal Services Expenditure Detail
Department of Administration

Scenario: FY2024 Governor (19867)
Component: Alaska Division of Information Technology (3141)
RDU: Office of Information Technology (653)

PCN	Job Class Title	Time Status	Retire Code	Barg Unit	Location	Salary Sched	Range / Step	Comp Months	Split / Count	Annual Salaries	COLA	Premium Pay	Annual Benefits	Total Costs	UGF Amount
02-6642	2 Data Processing Technician	FT	A	GP	Juneau	205	15A / B	12.0		54,096	2,384	15,245	45,015	116,740	0
02-6645	2 DP Prod Mgr	FT	A	SS	Anchorage	200	19M	12.0		95,638	1,454	10,085	61,340	168,517	0
02-6647	Systems Programmer 3	FT	A	SS	Juneau	205	23K / L	12.0		125,674	1,776	3,500	70,139	201,089	0
02-6649	2 Data Processing Technician	FT	A	GP	Juneau	205	15G / J	12.0		67,153	2,527	6,351	46,577	122,608	0
02-8094	2 Micro/Net Tc 2	FT	A	GP	Juneau	205	16A / B	12.0		57,761	2,034	1,400	41,196	102,391	0
02-9001	Systems Programmer 2	FT	A	GP	Anchorage	200	22G	12.0		99,548	3,474	1,500	56,912	161,434	0
02-9014	Systems Programmer 3	FT	A	SS	Anchorage	200	23J / K	12.0		124,266	1,709	0	68,297	194,272	0
02-N18007	Systems Programmer 4	NP	N	SS	Anchorage	600	25A	12.0		76,174	856	0	31,133	108,163	0
02-T183	St Chf Inf Ofc	FT	A	XE	Anchorage	N00	28V / W	12.0		206,646	0	0	96,215	302,861	0
02-X069	Chief Technology Officer 3	FT	A	XE	Juneau	N05	26O / P	12.0		162,105	0	0	82,234	244,339	0
03-0027	Systems Programmer 3	FT	A	SS	Anchorage	200	23E / F	12.0		109,171	1,597	6,932	65,234	182,934	0
03-0118	Systems Programmer 2	FT	A	GP	Anchorage	200	22G	12.0		99,548	3,540	3,432	57,637	164,157	0
03-0200	Micro/Net Tc 2	FT	A	GP	Anchorage	200	16L / M	12.0		75,767	2,605	0	47,426	125,798	0
03-0228	Systems Programmer 2	FT	A	GP	Anchorage	200	22G	12.0		99,548	3,437	432	56,511	159,928	0
03-0254	P3 Manager	FT	A	SS	Juneau	205	24L / M	12.0		140,275	1,929	0	74,304	216,508	0
03-0257	DPT Tech Ofc 2	FT	A	GG	Anchorage	200	24M	12.0		131,216	4,770	7,532	71,057	214,575	0
03-0280	Micro/Net Tc 2	FT	A	GP	Juneau	205	16B / C	12.0		59,491	2,045	0	41,320	102,856	0
03-0334	Micro/Net Tc 2	FT	A	GP	Anchorage	200	16A / B	12.0		54,847	1,886	0	39,577	96,310	0
03-6525	Micro/Net Sp 1	FT	A	GP	Anchorage	200	18F / G	12.0		74,618	2,565	0	46,995	124,178	0
04-1024	Systems Programmer 2	FT	A	GP	Fairbanks	203	22A / B	12.0		84,433	2,903	0	50,678	138,014	0
04-1139	DPT Tech Ofc 2	FT	A	SS	Anchorage	200	24K	12.0		125,320	1,723	0	68,693	195,736	0
04-1149	Systems Programmer 2	FT	A	GP	Anchorage	200	22B / C	12.0		85,670	2,945	0	51,142	139,757	0
04-1151	Micro/Net Sp 1	FT	A	GP	Juneau	205	18K	12.0		85,761	2,948	0	51,176	139,885	0
04-4035	Micro/Net Sp 1	FT	A	GP	Juneau	205	18J	12.0		83,070	2,871	432	50,329	136,702	0
04-6064	P3 Manager	FT	A	SS	Anchorage	200	24C / D	12.0		107,715	1,481	0	62,087	171,283	0
04-7068	Micro/Net Tc 2	FT	A	GP	Anchorage	200	16A / B	12.0		55,081	1,929	1,035	40,053	98,098	0
04-7110	Micro/Net Tc 2	FT	A	GP	Anchorage	200	16E / F	12.0		64,069	2,244	1,193	43,485	110,991	0
04-7168	Bus An/IA 3	FT	A	GP	Juneau	205	21B / C	12.0		83,391	2,867	0	50,287	136,545	0
04-7207	Micro/Net Sp 1	FT	A	GP	Anchorage	200	18B / C	12.0		66,383	2,334	1,500	44,468	114,685	0
05-2074	Micro/Net Sp 1	FT	A	GP	Anchorage	200	18F / G	12.0		74,425	2,559	0	46,923	123,907	0
05-7703	Micro/Net Sp 2	FT	A	GP	Anchorage	200	20G / J	12.0		90,118	3,098	0	52,811	146,027	0
05-7718	Data Processing Manager 1	FT	A	SS	Juneau	205	22F	12.0		107,806	1,488	432	62,283	172,009	0
05-7720	DPT Tech Ofc 2	FT	A	SS	Anchorage	200	24D / E	12.0		110,615	1,527	432	63,337	175,911	0
05-7724	Micro/Net Sp 1	FT	A	GP	Juneau	205	18B / C	12.0		69,618	2,393	0	45,119	117,130	0
06-0360	Micro/Net Tc 2	FT	A	GP	Juneau	205	16B / C	12.0		59,681	2,129	2,256	42,237	106,303	0
06-0617	DPT Tech Ofc 3	FT	A	SS	Juneau	205	25P / Q	12.0		166,191	2,184	0	83,660	252,035	0

Note: If a position is split, an asterisk (*) will appear in the Split/Count column. If the split position is also counted in the component, two asterisks (**) will appear in this column.
 [No valid job title] appearing in the Job Class Title indicates that the PCN has an invalid class code or invalid range for the class code effective date of this scenario.

Personal Services Expenditure Detail
Department of Administration

Scenario: FY2024 Governor (19867)
Component: Alaska Division of Information Technology (3141)
RDU: Office of Information Technology (653)

PCN	Job Class Title	Time Status	Retire Code	Barg Unit	Location	Salary Sched	Range / Step	Comp Months	Split / Count	Annual Salaries	COLA	Premium Pay	Annual Benefits	Total Costs	UGF Amount
06-0657	Data Processing Manager 1	FT	A	SS	Juneau	205	22B / C	12.0		95,993	1,320	0	57,689	155,002	0
06-1010	Micro/Net Tc 2	FT	A	GP	Anchorage	200	16A / B	12.0		55,499	1,979	2,071	40,599	100,148	0
06-1447	Micro/Net Sp 2	FT	A	SS	Juneau	205	20C	12.0		85,218	1,172	0	53,646	140,036	0
06-1580	Micro/Net Sp 2	FT	A	GP	Anchorage	200	20D / E	12.0		79,640	2,738	0	48,880	131,258	0
06-1791	Micro/Net Tc 2	FT	A	GP	Juneau	205	16A / B	12.0		56,778	1,997	1,305	40,791	100,871	0
06-1913	Micro/Net Tc 2	FT	A	GP	Anchorage	200	16C / D	12.0		57,971	2,039	1,330	41,248	102,588	0
06-1944	Systems Programmer 2	FT	A	GP	Anchorage	200	22F / G	12.0		98,863	3,399	0	56,092	158,354	0
06-2283	Database Specialist 3	FT	A	GP	Juneau	205	22F / G	12.0		103,277	3,929	11,000	61,875	180,081	0
06-3974	Database Specialist 2	FT	A	GP	Juneau	205	21J	12.0		101,634	3,687	5,600	59,233	170,154	0
06-4066	Systems Programmer 2	FT	A	GP	Juneau	205	22G	12.0		104,520	3,722	3,732	59,615	171,589	0
06-4500	Micro/Net Sp 1	FT	A	GP	Anchorage	200	18C / D	12.0		68,067	2,355	432	44,699	115,553	0
06-4863	Micro/Net Tc 2	FT	A	GP	Juneau	205	16B / C	12.0		59,870	2,136	2,256	42,308	106,570	0
06-8096	Micro/Net Sp 1	FT	A	GP	Juneau	205	18B / C	12.0		68,505	2,355	0	44,702	115,562	0
06-8532	Systems Programmer 2	FT	A	GP	Anchorage	200	22K	12.0		107,055	3,799	3,432	60,453	174,739	0
06-8596	Micro/Net Tc 2	FT	A	GP	Anchorage	200	16J / K	12.0		70,607	2,482	1,597	46,090	120,776	0
07-1227	Micro/Net Tc 2	FT	A	GP	Juneau	99	16Q	12.0		94,536	3,250	0	54,469	152,255	0
07-1732	Micro/Net Sp 1	FT	A	GP	Anchorage	200	18M / N	12.0		87,676	3,014	0	51,895	142,585	0
07-3045	Systems Programmer 2	FT	A	SS	Juneau	205	22C / D	12.0		99,707	1,371	0	59,083	160,161	0
07-4543	Micro/Net Sp 1	FT	A	GP	Juneau	205	18C	12.0		69,771	2,399	0	45,177	117,347	0
07-5016	Data Processing Technician 2	FT	A	GP	Juneau	205	15C / D	12.0		57,866	2,260	7,870	43,663	111,659	0
07-5023	Systems Programmer 2	FT	A	GP	Juneau	205	22L	12.0		116,045	4,097	3,132	63,714	186,988	0
07-5080	Chief Technology Officer 3	FT	A	XE	Juneau	N05	26L / M	12.0		147,518	0	0	76,877	224,395	0
07-5336	DPT Tech Ofc 2	FT	A	SS	Juneau	205	24N / O	12.0		147,985	2,035	0	77,197	227,217	0
07-5400	P3 Manager	FT	A	SS	Juneau	99	24Q / R	12.0		165,223	2,171	0	83,356	250,750	0
07-5490	Data Processing Technician 2	FT	A	GP	Juneau	205	15K	12.0		70,025	2,792	11,190	49,471	133,478	0
07-5758	Systems Programmer 2	FT	A	GP	Anchorage	200	22K / L	12.0		109,658	3,785	432	60,304	174,179	0
08-0415	Systems Programmer 2	FT	A	GP	Anchorage	200	22E / F	12.0		93,422	3,330	3,432	55,338	155,522	0
08-0424	Data Comm Sp 2	FT	A	GP	Anchorage	200	21L / M	12.0		105,290	3,672	1,530	59,078	169,570	0
08-1116	Systems Programmer 2	FT	A	GP	Anchorage	200	22A / B	12.0		82,394	2,833	0	49,913	135,140	0
08-1119	Micro/Net Sp 2	FT	A	GP	Anchorage	200	20B / C	12.0		75,779	2,620	432	47,593	126,424	0
08-1122	DPT Tech Ofc 2	FT	A	SS	Juneau	205	24C / D	12.0		113,245	1,557	0	64,162	178,964	0
08-2072	Systems Programmer 3	FT	A	SS	Fairbanks	203	23N	12.0		132,974	1,897	5,000	73,440	213,311	0
08-3096	Micro/Net Sp 1	FT	A	GP	Anchorage	200	18L	12.0		84,338	2,914	432	50,804	138,488	0
09-0221	Data Comm Sp 1	FT	A	GP	Anchorage	200	19B / C	12.0		70,077	2,409	0	45,292	117,778	0
09-0227	Micro/Net Tc 2	FT	A	GP	Joint Base Elmendorf - Richardson	200	16A / B	12.0		55,616	1,912	0	39,866	97,394	0

Note: If a position is split, an asterisk (*) will appear in the Split/Count column. If the split position is also counted in the component, two asterisks (**) will appear in this column.
[No valid job title] appearing in the Job Class Title indicates that the PCN has an invalid class code or invalid range for the class code effective date of this scenario.

Personal Services Expenditure Detail
Department of Administration

Scenario: FY2024 Governor (19867)
Component: Alaska Division of Information Technology (3141)
RDU: Office of Information Technology (653)

PCN	Job Class Title	Time Status	Retire Code	Barg Unit	Location	Salary Sched	Range / Step	Comp Months	Split / Count	Annual Salaries	COLA	Premium Pay	Annual Benefits	Total Costs	UGF Amount
09-0303	Micro/Net Sp 2	FT	A	GP	Joint Base Elmendorf - Richardson	200	20F / G	12.0		85,781	2,949	0	51,184	139,914	0
09-0331	Systems Programmer 2	FT	A	GP	Joint Base Elmendorf - Richardson	200	22C / D	12.0		88,057	3,027	0	52,038	143,122	0
09-0334	Micro/Net Tc 2	FT	A	GP	Joint Base Elmendorf - Richardson	200	16B / C	12.0		55,912	1,922	0	39,977	97,811	0
09-0380	Micro/Net Tc 2	FT	A	GP	Joint Base Elmendorf - Richardson	200	16C / D	12.0		58,208	2,001	0	40,838	101,047	0
09-0409	Internet Specialist 2	FT	A	GP	Joint Base Elmendorf - Richardson	200	19F / G	12.0		78,960	2,715	0	48,624	130,299	0
09-0415	DPT Tech Ofc 2	FT	A	SS	Joint Base Elmendorf - Richardson	200	24J / K	12.0		123,838	1,703	0	68,137	193,678	0
10-0283	Micro/Net Sp 1	FT	A	GP	Anchorage	99	18O	12.0		95,591	3,301	432	55,026	154,350	0
10-0284	Micro/Net Tc 2	FT	A	GP	Anchorage	200	16C / D	12.0		58,208	2,001	0	40,838	101,047	0
10-0335	Admn OPS Mgr 2	FT	A	SS	Juneau	205	23J	12.0		119,288	1,640	0	66,429	187,357	0
10-0377	DPT Tech Ofc 2	FT	A	SS	Anchorage	200	24L / M	12.0		132,373	1,826	432	71,501	206,132	0
10-0381	Database Specialist 3	FT	A	GP	Anchorage	200	22F	12.0		96,389	3,417	3,000	56,289	159,095	0
10-0386	Systems Programmer 2	FT	A	GP	Anchorage	200	22B / C	12.0		84,609	2,988	2,300	51,607	141,504	0
10-0391	Analyst/Programmer 4	FT	A	GP	Anchorage	200	20F / G	12.0		85,781	2,949	0	51,184	139,914	0
10-0407	Systems Programmer 2	FT	A	GP	Anchorage	200	22B / C	12.0		85,537	2,941	0	51,092	139,570	0
10-0423	Micro/Net Tc 2	FT	A	GP	Palmer	200	16C	12.0		57,662	2,058	2,200	41,459	103,379	0
10-0432	Micro/Net Tc 2	FT	A	GP	Anchorage	200	16C / D	12.0		58,517	2,012	0	40,954	101,483	0
11-0225	Systems Programmer 1	FT	A	GP	Anchorage	200	20F / G	12.0		84,963	2,936	432	51,039	139,370	0
11-0248	DPT Tech Ofc 2	FT	A	SS	Juneau	205	24F	12.0		123,427	1,697	0	67,982	193,106	0
11-1130	Micro/Net Sp 2	FT	A	GP	Fairbanks	203	20M	12.0		102,531	3,557	932	57,818	164,838	0
11-1283	Micro/Net Sp 2	FT	A	GP	Kodiak	211	20N	12.0		114,095	3,923	0	61,807	179,825	0
11-1340	Systems Programmer 3	FT	A	SS	Juneau	99	23R	12.0		159,405	2,143	0	81,481	243,029	0
11-1362	Micro/Net Tc 2	FT	A	GP	Anchorage	200	16G / J	12.0		66,685	2,307	432	44,181	113,605	0
11-1401	Micro/Net Sp 2	FT	A	GP	Juneau	205	16E / F	12.0		66,697	2,327	1,002	44,399	114,425	0
11-1678	Micro/Net Sp 1	FT	A	GP	Anchorage	200	18C / D	12.0		68,431	2,353	0	44,674	115,458	0
11-1972	Systems Programmer 2	FT	A	GP	Juneau	205	22F / G	12.0		102,503	3,539	432	57,620	164,094	0
11-2079	Micro/Net Tc 2	FT	A	GP	Anchorage	200	16C	12.0		57,662	1,998	443	40,800	100,903	0
11-4268	Micro/Net Sp 1	FT	A	GP	Anchorage	200	18A / B	12.0		63,940	2,213	432	43,151	109,736	0

Note: If a position is split, an asterisk (*) will appear in the Split/Count column. If the split position is also counted in the component, two asterisks (**) will appear in this column. [No valid job title] appearing in the Job Class Title indicates that the PCN has an invalid class code or invalid range for the class code effective date of this scenario.

Personal Services Expenditure Detail
Department of Administration

Scenario: FY2024 Governor (19867)
Component: Alaska Division of Information Technology (3141)
RDU: Office of Information Technology (653)

PCN	Job Class Title	Time Status	Retire Code	Barg Unit	Location	Salary Sched	Range / Step	Comp Months	Split / Count	Annual Salaries	COLA	Premium Pay	Annual Benefits	Total Costs	UGF Amount
11-5013	Micro/Net Tc 2	FT	A	GP	Juneau	205	16B / C	12.0		59,113	2,048	451	41,347	102,959	0
11-5325	Data Processing Manager 1	FT	A	SS	Juneau	205	22C / D	12.0		99,176	1,364	0	58,883	159,423	0
12-1382	Micro/Net Tc 2	FT	A	GP	Anchorage	100	16F / G	12.0		65,169	2,290	1,430	43,987	112,876	0
12-1671	Data Comm Sp 1	FT	A	GP	Anchorage	200	19B / C	12.0		70,077	2,476	1,932	46,016	120,501	0
12-1717	Systems Programmer 1	FT	A	GP	Anchorage	100	20C	12.0		76,694	2,652	432	47,936	127,714	0
12-1778	Micro/Net Tc 2	FT	A	GP	Anchorage	200	16A / B	12.0		55,165	1,897	0	39,697	96,759	0
12-1848	Micro/Net Tc 2	FT	A	GP	Anchorage	200	16P / Q	12.0		88,890	3,106	1,443	52,892	146,331	0
12-2016	DPT Tech Ofc 3	FT	A	SS	Anchorage	100	25F / J	12.0		129,412	1,780	0	70,228	201,420	0
12-3804	Data Processing Manager 1	FT	A	SS	Anchorage	100	22M	12.0		116,688	1,605	0	65,454	183,747	0
12-4412	Data Comm Sp 2	FT	A	GP	Juneau	205	21G / J	12.0		101,327	3,516	932	57,366	163,141	0
12-4616	Systems Programmer 3	FT	A	SS	Juneau	205	23K / L	12.0		123,377	1,697	0	67,964	193,038	0
12-4627	Micro/Net Sp 1	FT	A	GP	Anchorage	100	18D / E	12.0		69,956	2,433	800	45,546	118,735	0
12-4900	Data Processing Manager 1	FT	A	SS	Anchorage	100	22C / D	12.0		94,588	1,321	1,500	57,725	155,134	0
12-5108	Micro/Net Sp 1	FT	A	GP	Anchorage	200	18B / C	12.0		65,960	2,320	1,532	44,322	114,134	0
12-5470	Systems Programmer 2	FT	A	GP	Anchorage	99	22N / O	12.0		124,446	4,278	0	65,691	194,415	0
18-7043	Systems Programmer 3	FT	A	SS	Juneau	205	23J	12.0		119,288	1,640	0	66,429	187,357	0
18-7430	Systems Programmer 1	FT	A	GP	Anchorage	200	20C	12.0		75,972	2,654	1,232	47,966	127,824	0
18-7543	Data Processing Manager 2	FT	A	SS	Anchorage	200	23J	12.0		113,610	1,562	0	64,299	179,471	0
18-7552	DPT Tech Ofc 2	FT	A	SS	Juneau	205	24A / B	12.0		106,839	1,469	0	61,759	170,067	0
18-7596	Micro/Net Tc 2	FT	N	GP	Juneau	205	16B / C	12.0		59,476	1,684	432	26,439	88,031	0
18-7605	Micro/Net Sp 2	FT	A	GP	Fairbanks	203	20E / F	12.0		85,016	2,938	432	51,059	139,445	0
18-7686	Micro/Net Sp 2	FT	A	SS	Anchorage	200	20C	12.0		81,162	1,122	432	52,287	135,003	0
20-1010	Micro/Net Tc 2	FT	A	GP	Anchorage	200	16B / C	12.0		56,750	1,951	0	40,291	98,992	0
20-1023	DPT Tech Ofc 2	FT	A	GP	Anchorage	200	24C	12.0		99,548	3,422	0	56,349	159,319	0
20-1047	Micro/Net Sp 2	FT	A	GP	Juneau	205	20G	12.0		91,124	3,133	0	53,188	147,445	0
20-1049	Micro/Net Sp 1	FT	A	GP	Anchorage	200	18B / C	12.0		65,116	2,239	0	43,430	110,785	0
20-2055	Micro/Net Sp 1	FT	A	GP	Anchorage	200	18B / C	12.0		65,630	2,256	0	43,623	111,509	0
20-6858	Data Comm Sp 1	FT	A	GP	Juneau	205	19B / C	12.0		73,359	2,589	1,932	47,248	125,128	0
21-2050	Micro/Net Sp 1	FT	A	GP	Anchorage	200	18C / D	12.0		68,584	2,373	432	44,893	116,282	0
21-3087	Micro/Net Sp 1	FT	A	GP	Juneau	205	18E / F	12.0		76,645	2,701	1,932	48,481	129,759	0
25-0108	Micro/Net Sp 2	FT	A	SS	Anchorage	200	20A / B	12.0		77,575	1,073	432	50,941	130,021	0
25-0109	Micro/Net Tc 2	FT	A	GP	Anchorage	200	16B / C	12.0		56,495	1,942	0	40,196	98,633	0
25-0122	Data Processing Manager 1	FT	A	SS	Anchorage	200	22N / O	12.0		123,243	1,701	432	68,075	193,451	0
25-0139	Systems Programmer 3	FT	A	GP	Anchorage	200	23D / E	12.0		96,415	3,366	1,500	55,736	157,017	0
25-0185	Data Processing Manager 1	FT	A	SS	Juneau	205	22E / F	12.0		106,278	1,467	432	61,710	169,887	0
25-0377	Data Processing Manager 1	FT	A	SS	Anchorage	200	22J / K	12.0		107,867	1,489	432	62,306	172,094	0
25-0383	Micro/Net Sp 1	FT	A	GP	Anchorage	99	18P	12.0		99,182	3,410	0	56,212	158,804	0
25-0406	Micro/Net Sp 1	FT	A	GP	Anchorage	200	18D / E	12.0		70,548	2,425	0	45,468	118,441	0

Note: If a position is split, an asterisk (*) will appear in the Split/Count column. If the split position is also counted in the component, two asterisks (**) will appear in this column.
[No valid job title] appearing in the Job Class Title indicates that the PCN has an invalid class code or invalid range for the class code effective date of this scenario.

Personal Services Expenditure Detail
Department of Administration

Scenario: FY2024 Governor (19867)
Component: Alaska Division of Information Technology (3141)
RDU: Office of Information Technology (653)

PCN	Job Class Title	Time Status	Retire Code	Barg Unit	Location	Salary Sched	Range / Step	Comp Months	Split / Count	Annual Salaries	COLA	Premium Pay	Annual Benefits	Total Costs	UGF Amount
25-0431	Micro/Net Sp 1	FT	A	GP	Anchorage	200	18L / M	12.0		84,796	2,915	0	50,814	138,525	0
25-0602	Micro/Net Sp 1	FT	A	GP	Juneau	205	18B / C	12.0		69,752	2,398	0	45,170	117,320	0
25-0959	Micro/Net Tc 2	FT	A	GP	Ketchikan	200	16B / C	12.0		56,914	1,957	0	40,353	99,224	0
25-1376	Data Processing Manager 1	FT	A	SS	Fairbanks	203	22M	12.0		120,182	1,736	6,032	69,028	196,978	0
25-1462	Micro/Net Tc 1	FT	A	GP	Fairbanks	203	14A / B	12.0		49,213	1,707	432	37,625	88,977	0
25-1561	Micro/Net Tc 2	FT	A	GG	Fairbanks	203	16A / B	12.0		56,856	1,970	432	40,493	99,751	0
25-1610	Micro/Net Sp 2	FT	A	GP	Fairbanks	203	20G / J	12.0		91,260	3,152	432	53,401	148,245	0
25-2297	Micro/Net Sp 1	FT	A	GP	Fairbanks	203	18L	12.0		86,873	2,987	0	51,593	141,453	0
25-2496	Micro/Net Sp 2	FT	A	GP	Juneau	205	20B / C	12.0		79,328	2,727	0	48,763	130,818	0
25-2554	DPT Tech Ofc 3	FT	A	SS	Anchorage	200	25D / E	12.0		120,383	1,656	0	66,840	188,879	0
25-2938	Systems Programmer 3	FT	A	SS	Juneau	205	23J / K	12.0		122,270	1,792	8,032	70,562	202,656	0
25-3342	Micro/Net Sp 1	FT	A	GP	Anchorage	200	18C / D	12.0		66,475	2,300	432	44,102	113,309	0
25-3738	Data Processing Manager 2	FT	A	SS	Anchorage	200	23E	12.0		106,059	1,459	0	61,466	168,984	0
25-3769	Micro/Net Tc 2	FT	A	GP	Juneau	205	16A / B	12.0		57,322	2,035	1,867	41,206	102,430	0
25-3770	Micro/Net Tc 2	FT	A	GP	Anchorage	200	16B / C	12.0		57,123	1,964	0	40,431	99,518	0

Total Positions				Total Salary Costs:	21,248,697
Full Time Positions:	224	New	0	Total COLA:	549,453
Part Time Positions:	0		0	Total Premium Pay:	423,226
Non Permanent Positions:	1		0	Total Benefits:	12,518,831
Positions in Component:	225		0	Total Pre-Vacancy:	34,740,207
				Minus Vacancy Adjustment of 5.59%:	(1,943,607)
				Total Post-Vacancy:	32,796,600
Total Component Months:	2,700.0			Plus Lump Sum Premium Pay:	0
				Personal Services Line 100:	32,796,600

PCN Funding Sources:	Pre-Vacancy	Post-Vacancy	Percent
1081 Information Services Fund	34,740,207	32,796,600	100.00%
Total PCN Funding:	34,740,207	32,796,600	100.00%

Note: If a position is split, an asterisk (*) will appear in the Split/Count column. If the split position is also counted in the component, two asterisks (**) will appear in this column. [No valid job title] appearing in the Job Class Title indicates that the PCN has an invalid class code or invalid range for the class code effective date of this scenario.

Department of Administration
Alaska Division of Information Technology (3141)
RDU: Office of Information Technology (653)
FY2024 Governor's Budget
Position Totals PFT – 224 / NP - 1
OIT Senior Management

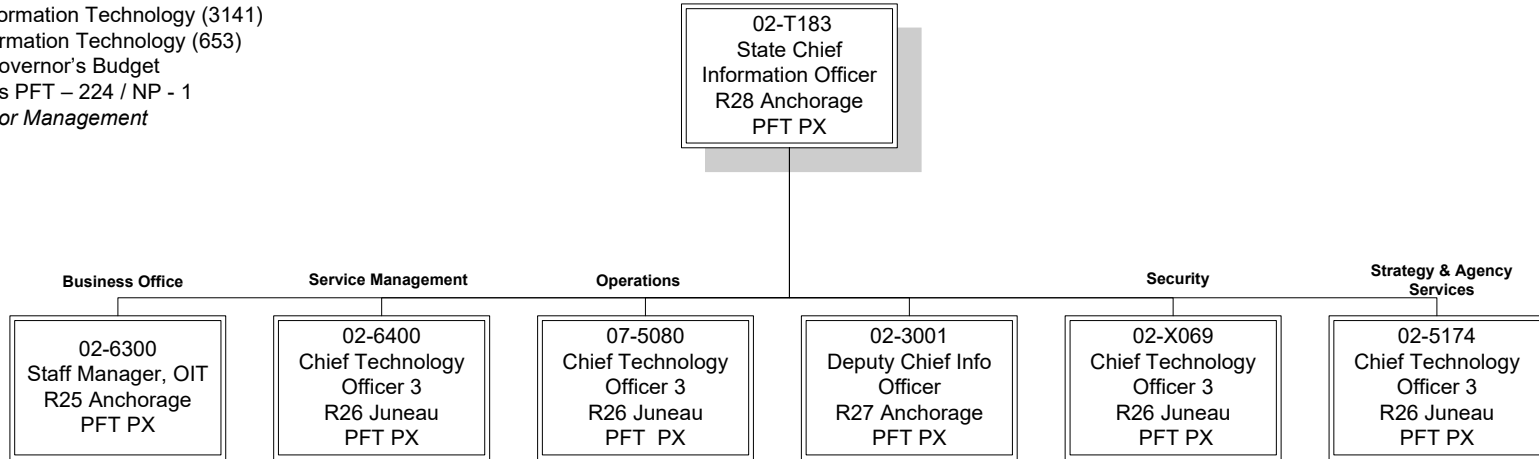

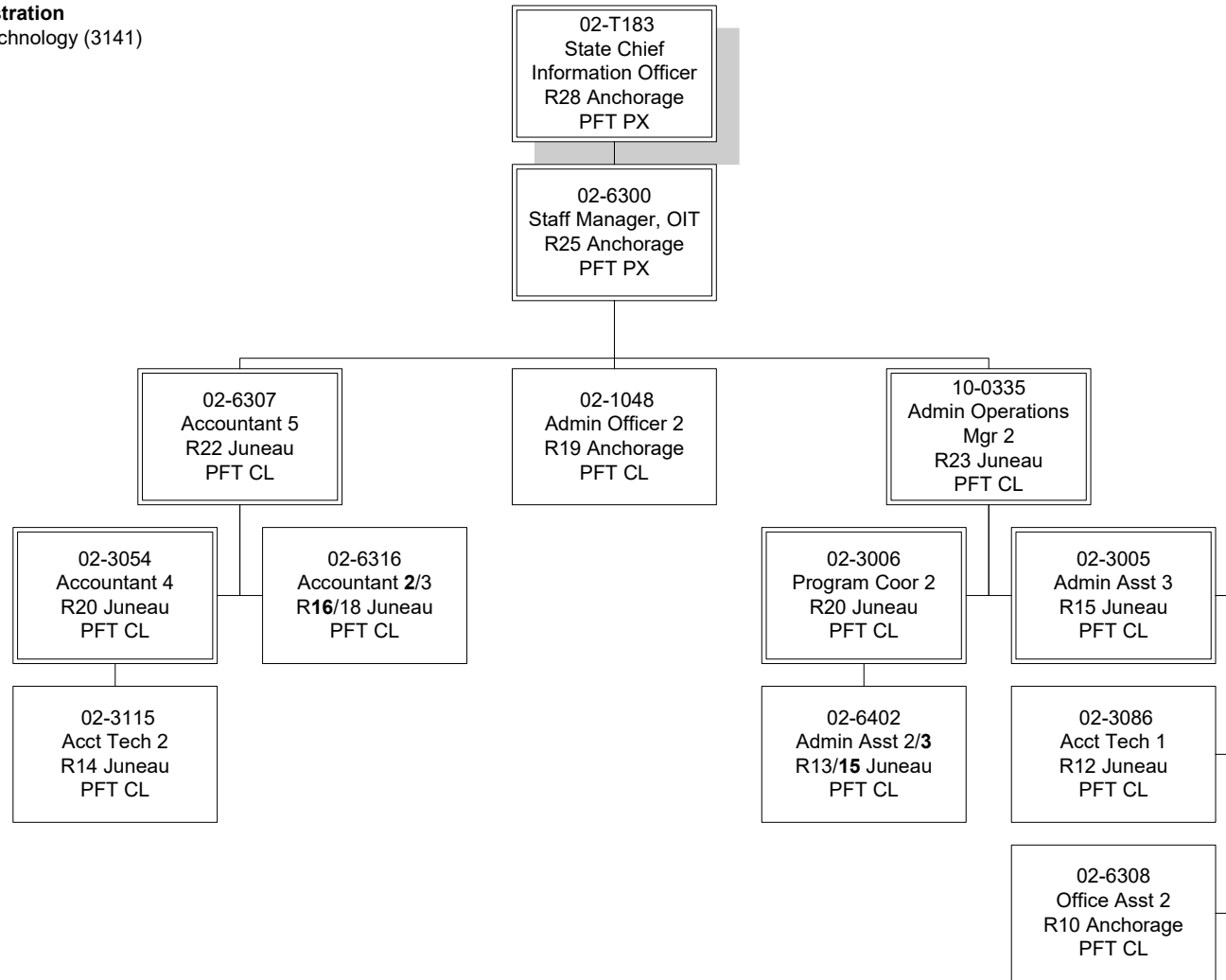

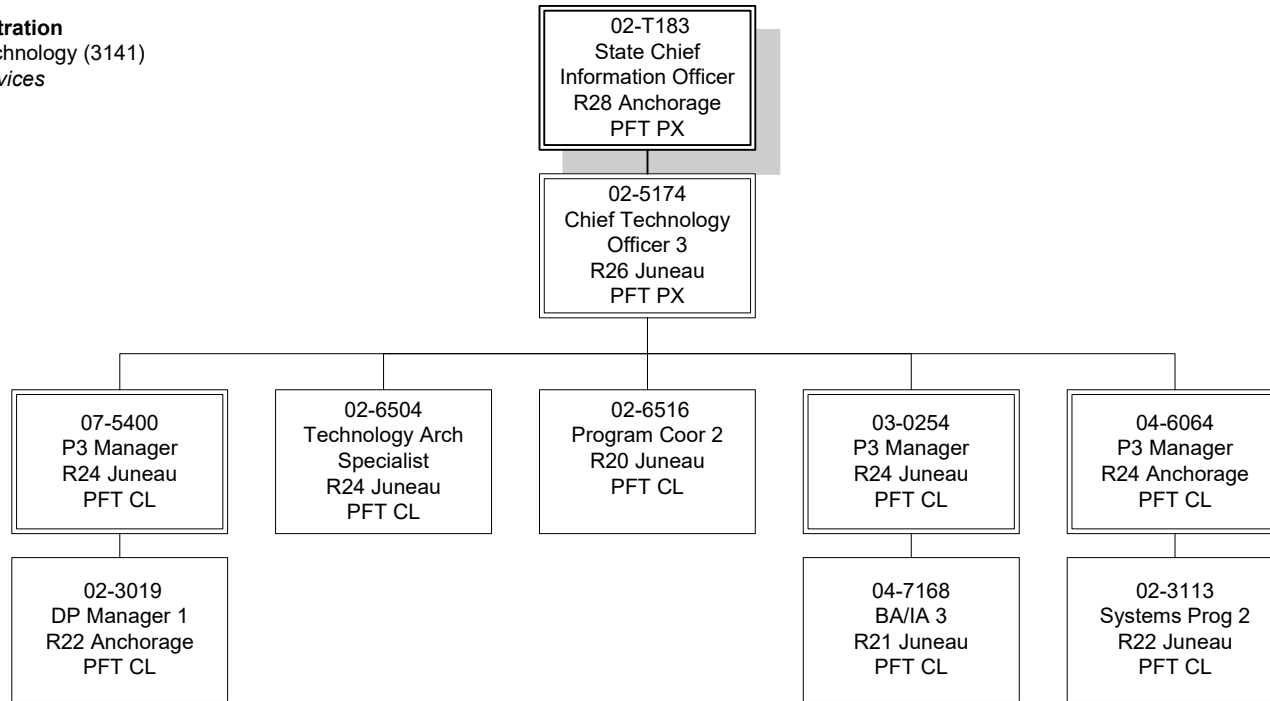

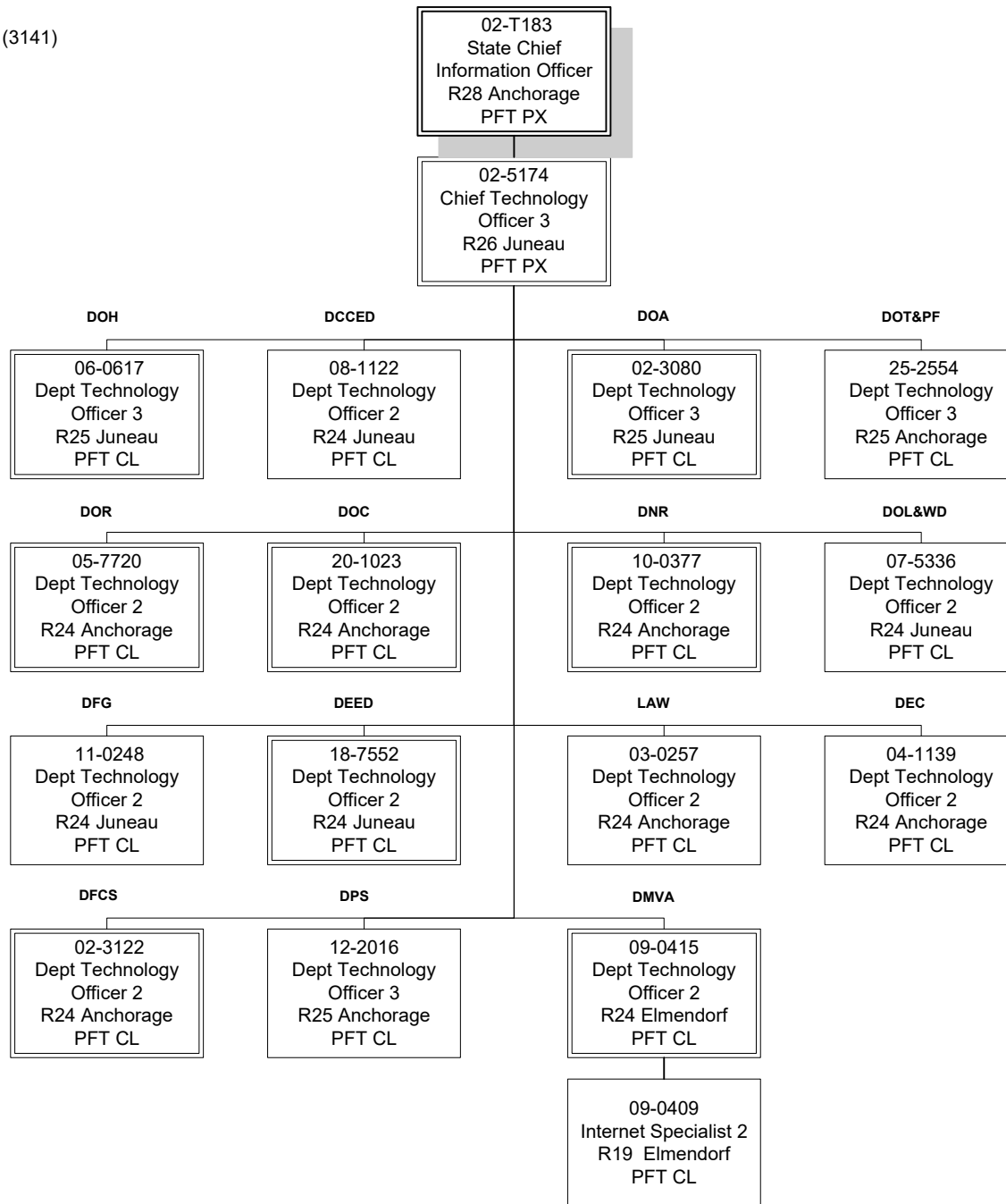

Department of Administration
Alaska Division of Information Technology (3141)
Service Desk
Automation & Knowledge Management
Endpoint Engineering

02-T183
State Chief
Information Officer
R28 Anchorage
PFT PX

02-6400
Chief Technology
Officer 3
R26 Juneau
PFT PX

Service Desk

**Endpoint
Engineering**

**Automation & Knowledge
Management**

02-6614
DP Prod Manager
R19 Juneau
PFT CL

12-4616
Systems Prog 3
R23 Juneau
PFT CL

02-6645
DP Prod Manager
R19 Anchorage
PFT CL

11-1340
Systems Prog 3
R23 Juneau
PFT CL

02-6649
DP Tech 2
R15 Juneau
PFT CL

02-6639
DP Tech 1/2
R13/15 Juneau
PFT CL

03-0228
Systems Prog 2
R22 Anchorage
PFT CL

07-3045
Systems Prog 2
R22 Juneau
PFT CL

02-6624
DP Tech 2
R15 Anchorage
PFT CL

02-6641
DP Tech 2
R15 Anchorage
PFT CL

02-6640
DP Tech 1/2
R13/15 Juneau
PFT CL

07-5490
DP Tech 2
R15 Juneau
PFT CL

07-5016
DP Tech 2
R15 Juneau
PFT CL

02-6642
DP Tech 1/2
R13/15 Juneau
PFT CL

Department of Administration
 Alaska Division of Information Technology (3141)
 Service Delivery Group A

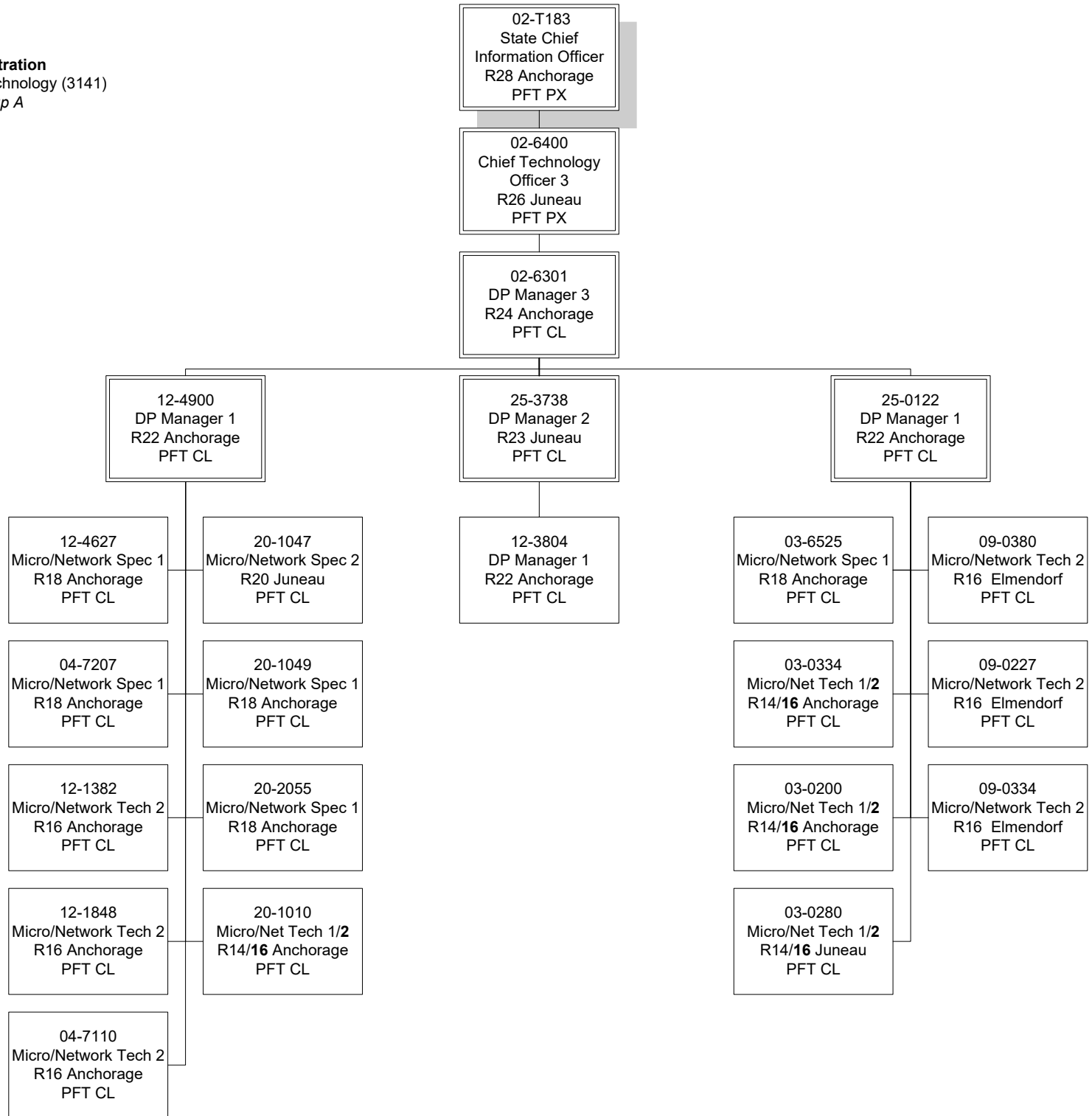

Department of Administration
 Alaska Division of Information Technology (3141)
 Service Delivery Group B

02-T183
 State Chief
 Information Officer
 R28 Anchorage
 PFT PX

02-6400
 Chief Technology
 Officer 3
 R26 Juneau
 PFT PX

02-6301
 DP Manager 3
 R24 Anchorage
 PFT CL

25-3738
 DP Manager 2
 R23 Anchorage
 PFT CL

25-1376
 DP Manager 1
 R22 Fairbanks
 PFT CL

05-7718
 DP Manager 1
 R22 Juneau
 PFT CL

06-0657
 DP Manager 1
 R22 Juneau
 PFT CL

18-7605
 Micro/Net Spec 1/2
 R18/20 Fairbanks
 PFT CL

25-1610
 Micro/Net Spec 1/2
 R18/20 Fairbanks
 PFT CL

25-1462
 Micro/Net Tech 1/2
 R14/16 Fairbanks
 PFT CL

25-2297
 Micro/Network Spec 1
 R18 Fairbanks
 PFT CL

10-0432
 Micro/Network Tech 2
 R16 Anchorage
 PFT CL

25-1561
 Micro/Net Tech 1/2
 R14/16 Fairbanks
 PFT CL

10-0423
 Micro/Net Tech 1/2
 R14/16 Palmer
 PFT CL

02-2095
 Micro/Network Spec 2
 R20 Juneau
 PFT CL

02-1155
 Micro/Network Spec 1
 R18 Juneau
 PFT CL

02-8094
 Micro/Net Tech 1/2
 R14/16 Juneau
 PFT CL

02-1105
 Micro/Network Spec 2
 R20 Anchorage
 PFT CL

04-7068
 Micro/Net Tech 1/2
 R14/16 Anchorage
 PFT CL

04-4035
 Micro/Network Spec 1
 R18 Juneau
 PFT CL

18-7686
 Micro/Network Spec 2
 R20 Anchorage
 PFT CL

10-0283
 Micro/Network Spec 1
 R18 Anchorage
 PFT CL

11-1130
 Micro/Network Spec 2
 R20 Fairbanks
 PFT CL

11-4268
 Micro/Network Spec 1
 R18 Anchorage
 PFT CL

11-1362
 Micro/Net Tech 1/2
 R14/16 Anchorage
 PFT CL

11-2079
 Micro/Net Tech 1/2
 R14/16 Anchorage
 PFT CL

11-1283
 Micro/Network Spec 2
 R20 Kodiak
 PFT CL

11-1678
 Micro/Network Spec 1
 R18 Anchorage
 PFT CL

11-1401
 Micro/Network Tech 2
 R16 Juneau
 PFT CL

11-5013
 Micro/Net Tech 1/2
 R14/16 Juneau
 PFT CL

05-7703
 Micro/Network Spec 2
 R20 Anchorage
 PFT CL

05-7724
 Micro/Network Spec 1
 R18 Juneau
 PFT CL

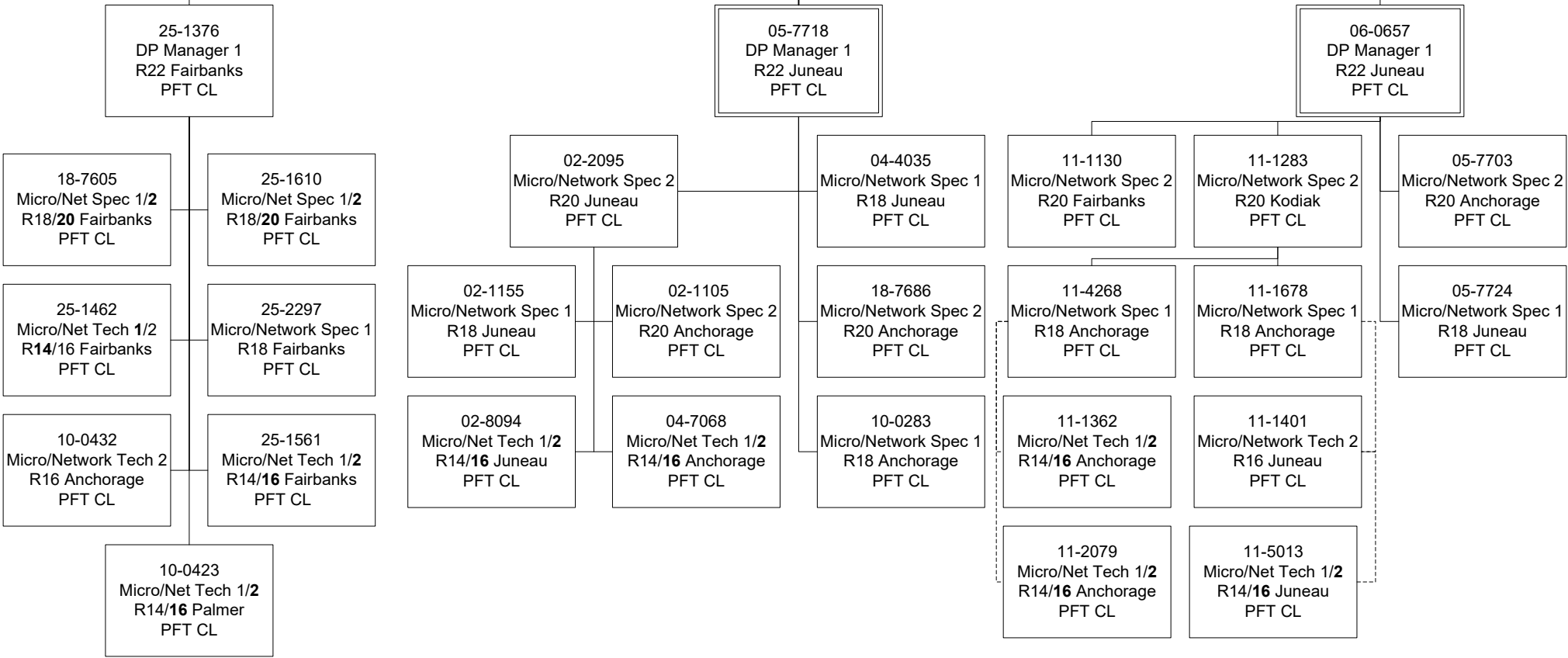

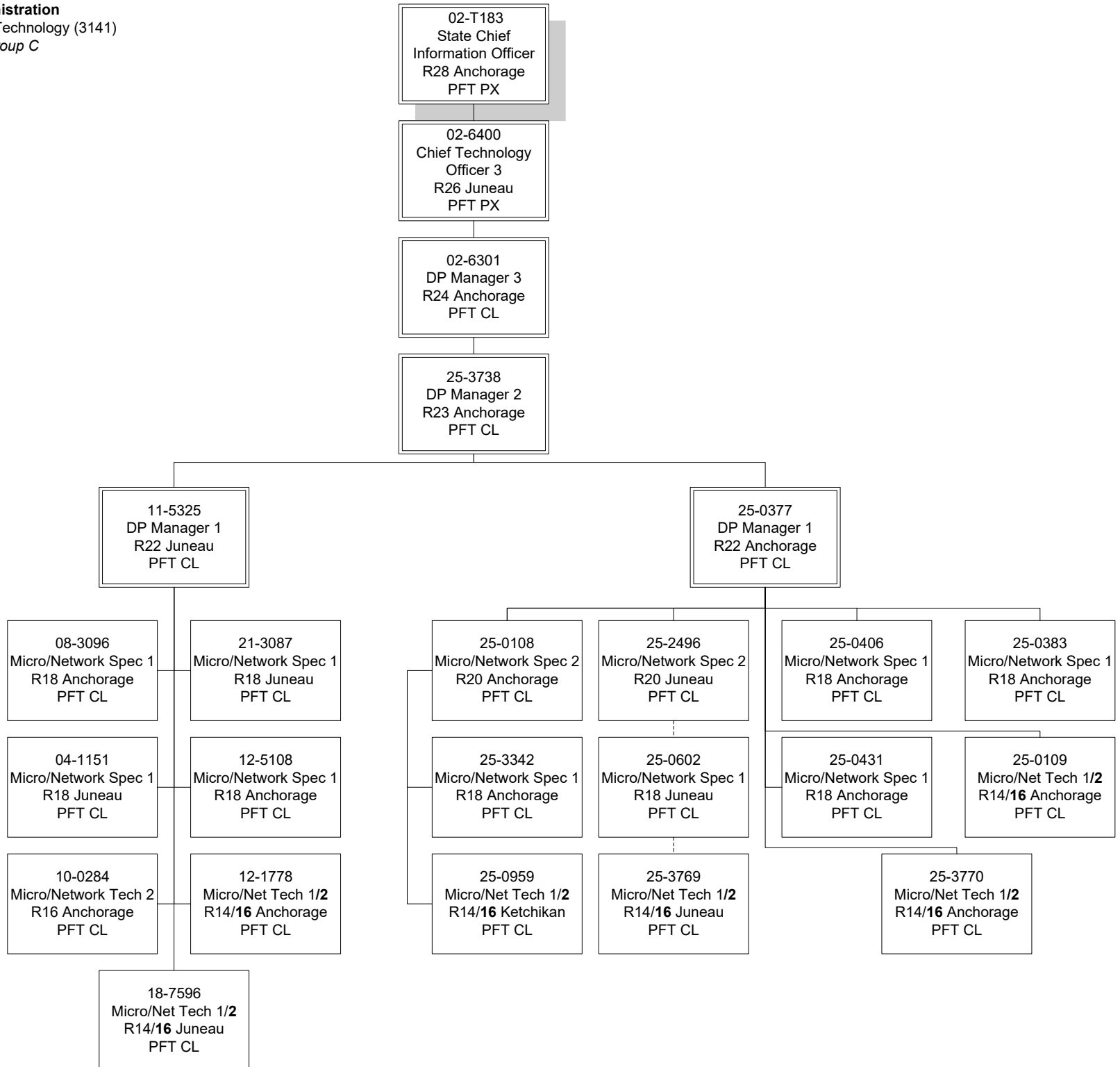

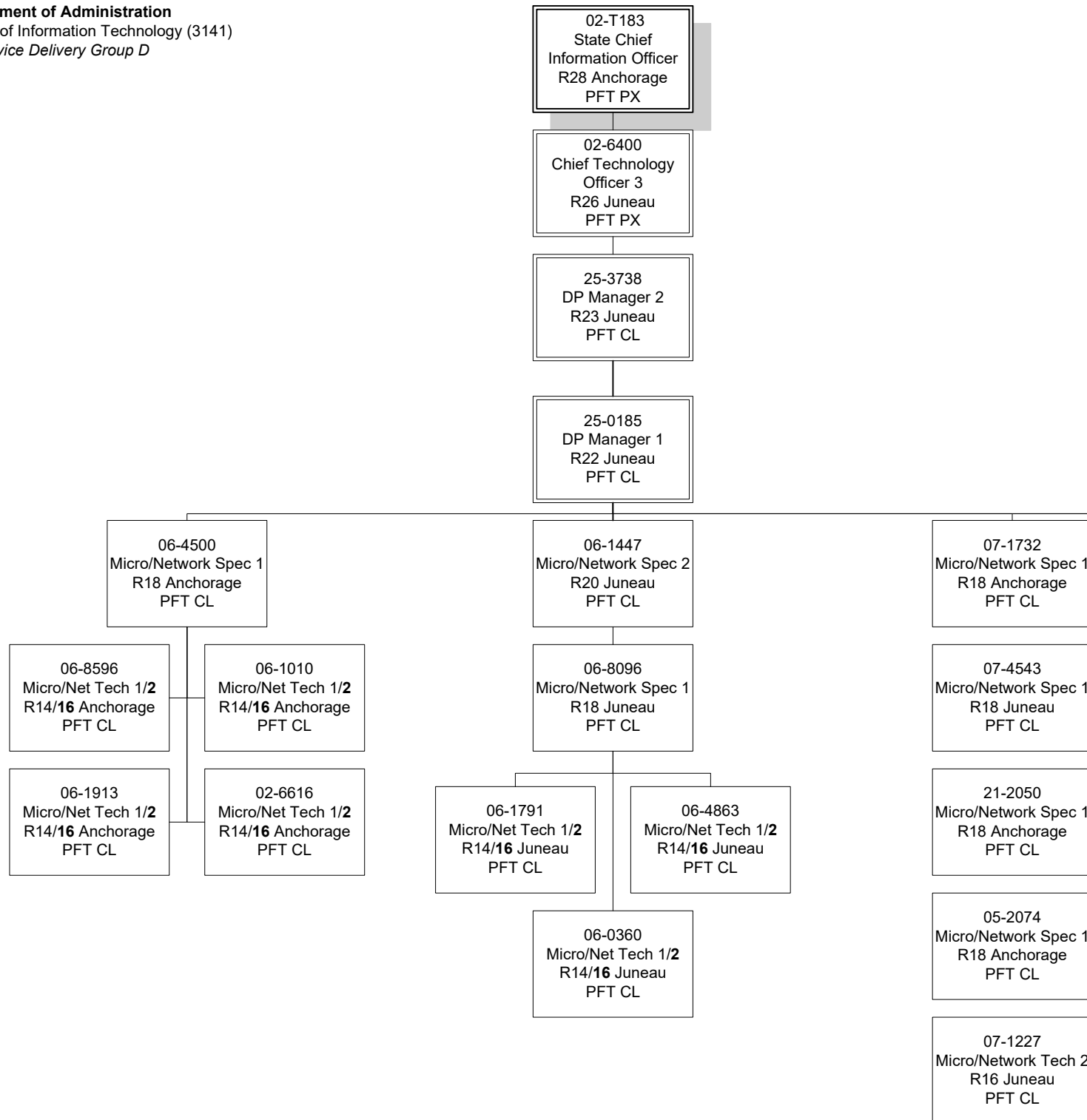

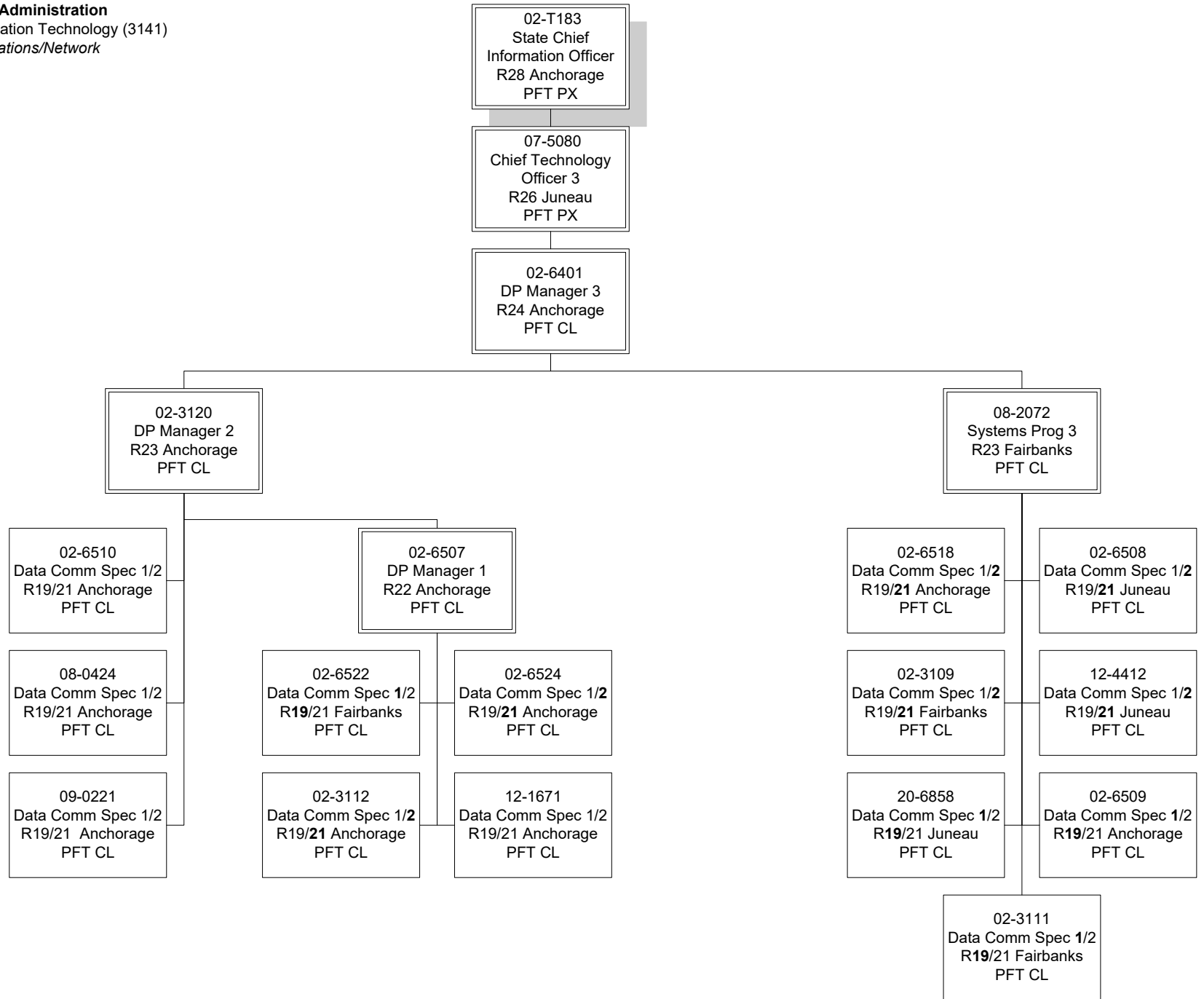

Department of Administration
 Alaska Division of Information Technology (3141)
Platform Services

02-T183
 State Chief
 Information Officer
 R28 Anchorage
 PFT PX

07-5080
 Chief Technology
 Officer 3
 R26 Juneau
 PFT PX

02-6601
 DP Manager 3
 R24 Anchorage
 PFT CL

**End Point Server
 Patch Management**

**Storage, Back Up
 & Disaster
 Recovery**

**Cloud
 Infrastructure**

**Database
 Services**

**Virtualization &
 Windows
 Administration**

18-7543
 DP Manager 2
 R23 Anchorage
 PFT CL

03-0027
 Systems Prog 3
 R23 Anchorage
 PFT CL

18-7043
 Systems Prog 3
 R23 Juneau
 PFT CL

02-6621
 Database Spec 3
 R22 Juneau
 PFT CL

02-3108
 Systems Prog 3
 R23 Anchorage
 PFT CL

03-0118
 Systems Prog 1/2
 R20/22 Anchorage
 PFT CL

02-3114
 Systems Prog 2
 R22 Juneau
 PFT CL

06-1944
 Systems Prog 2
 R22 Anchorage
 PFT CL

02-6511
 Systems Prog 3
 R23 Anchorage
 PFT CL

10-0381
 Database Spec 3
 R22 Anchorage
 PFT CL

02-6314
 Database Spec 3
 R22 Juneau
 PFT CL

02-6610
 Systems Prog 1/2
 R20/22 Juneau
 PFT CL

06-8532
 Systems Prog 2
 R22 Anchorage
 PFT CL

04-1024
 Systems Prog 1/2
 R20/22 Fairbanks
 PFT CL

09-0331
 Systems Prog 2
 R22 Elmendorf
 PFT CL

08-1116
 Systems Prog 1/2
 R20/22 Anchorage
 PFT CL

04-1149
 Systems Prog 1/2
 R20/22 Anchorage
 PFT CL

02-6607
 Database Spec 1/2/3
 R20/21/22 Anchorage
 PFT CL

02-6404
 Database Spec 1/2/3
 R20/21/22 Anchorage
 PFT CL

11-1972
 Systems Prog 1/2
 R20/22 Juneau
 PFT CL

02-6312
 Systems Prog 2
 R22 Anchorage
 PFT CL

06-1580
 Micro/Network Spec 2
 R20 Anchorage
 PFT CL

12-1717
 Systems Prog 1
 R20 Anchorage
 PFT CL

10-0407
 Systems Prog 1/2
 R20/22 Anchorage
 PFT CL

06-3974
 Database Spec 1/2/3
 R20/21/22 Juneau
 PFT CL

06-2283
 Database Spec 1/2/3
 R20/21/22 Juneau
 PFT CL

11-0225
 System Prog 1
 R20 Anchorage
 PFT CL

09-0303
 Micro/Network Spec 2
 R20 Elmendorf
 PFT CL

08-1119
 Micro/Network Spec 2
 R20 Anchorage
 PFT CL

Department of Administration
Alaska Division of Information Technology (3141)
Application Services

02-T183
State Chief
Information Officer
R28 Anchorage
PFT PX

07-5080
Chief Technology
Officer 3
R26 Juneau
PFT PX

02-6605
Systems Prog 4
R25 Anchorage
PFT CL

ID Mgmt & Directories

**Unix-Solaris-
Linux**

SP/Web Content

**Enterprise & PFT
CLpport Apps**

**Internal Svcs
PFT CLpport**

O365/PFT Cloud

25-2938
Systems Prog 3
R23 Juneau
PFT CL

02-6418
Systems Prog 2
R22 Juneau
PFT CL

02-1035
Internet Specialist 2
R19 Juneau
PFT CL

02-6408
Systems Prog 3
R23 Anchorage
PFT CL

02-6617
Analyst/Prog 5
R22 Juneau
PFT CL

02-6647
Systems Prog 3
R23 Juneau
PFT CL

08-0415
Systems Prog 1/2
R20/22 Anchorage
PFT CL

07-5023
Systems Prog 2
R22 Juneau
PFT CL

02-9001
Systems Prog 2
R22 Anchorage
PFT CL

02-6502
Systems Prog 2
R22 Anchorage
PFT CL

02-6415
Systems Prog 1/2
R20/22 Anchorage
PFT CL

02-6523
Systems Prog 1/2
R20/22 Anchorage
PFT CL

18-7430
Systems Prog 1/2
R20/22 Anchorage
PFT CL

02-5148
Systems Prog 1
R20 Juneau
PFT CL

10-0391
Analyst/Prog 4
R20 Anchorage
PFT CL

02-0013
Systems Prog 1/2
R20/22 Anchorage
PFT CL

06-4066
Systems Prog 1/2
R20/22 Juneau
PFT CL

02-6304
Systems Prog 2
R22 Anchorage
PFT CL

