

**Department of Administration**  
Alaska Division of Information Technology (3141)  
RDU: Office of Information Technology (653)  
FY2024 Governor's Budget  
Position Totals PFT – 224 / NP - 1  
*OIT Senior Management*

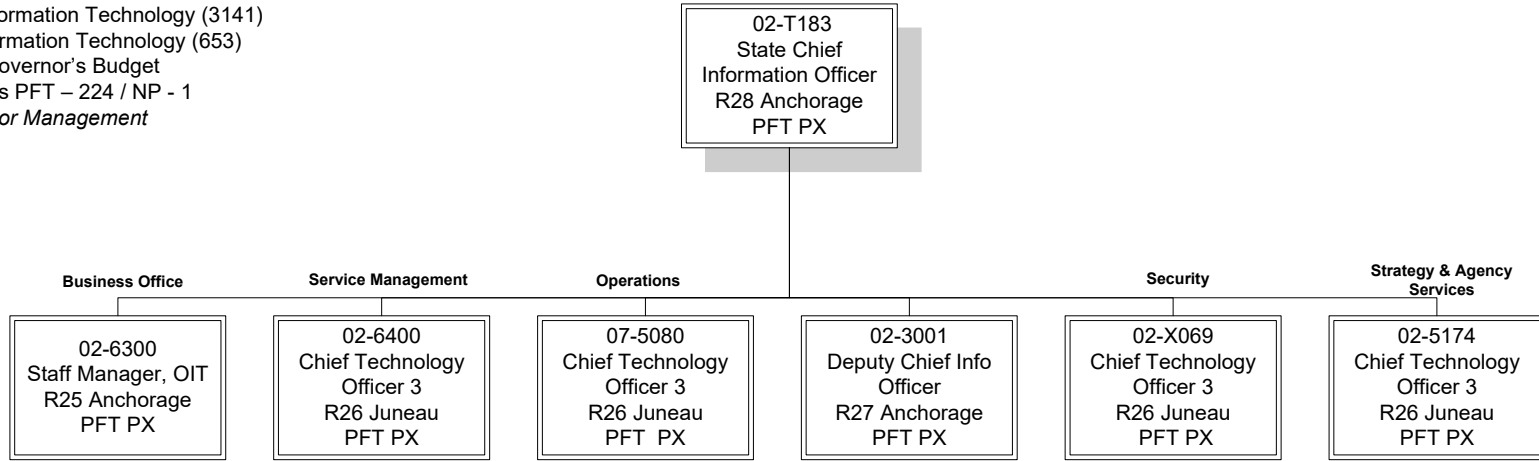

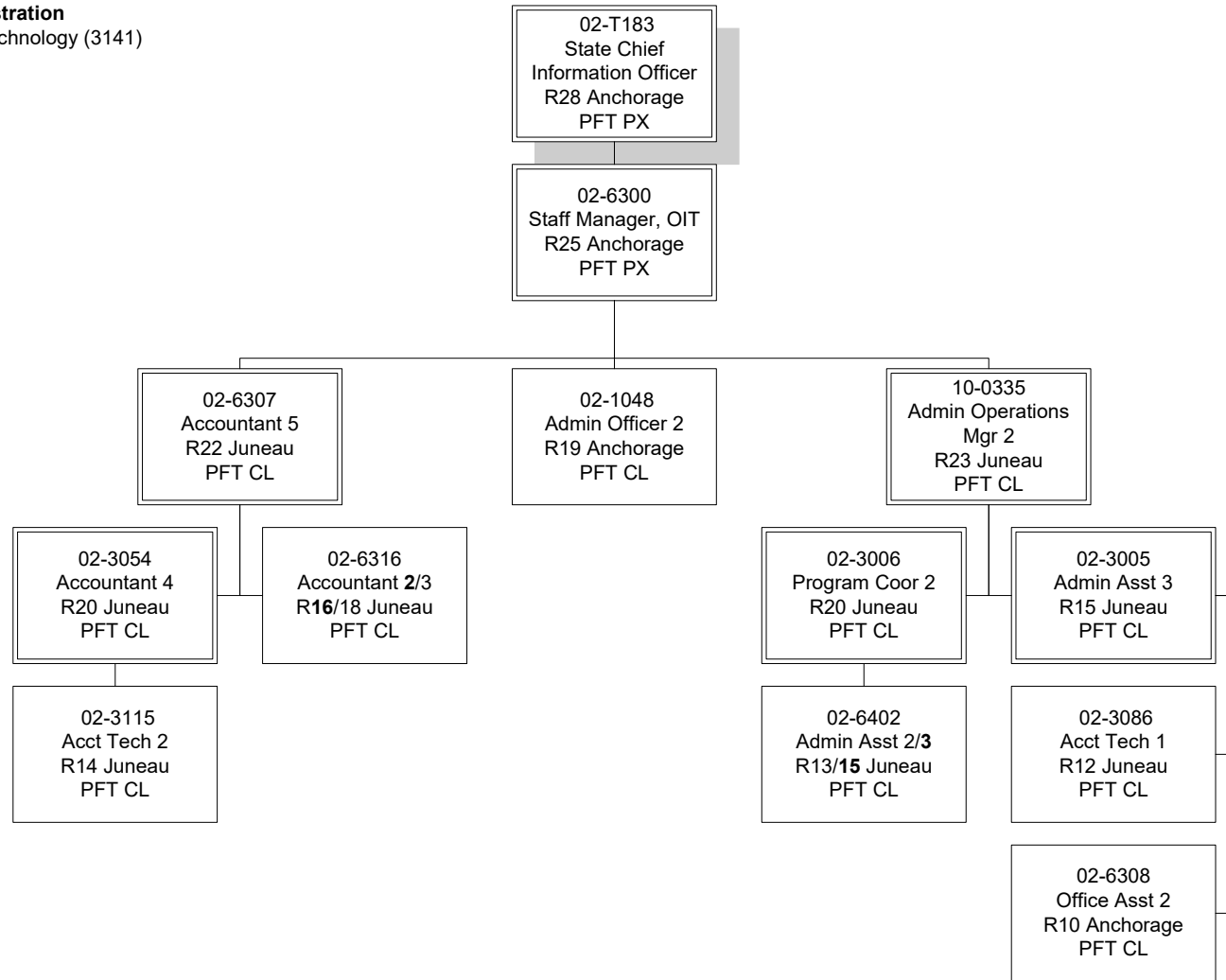

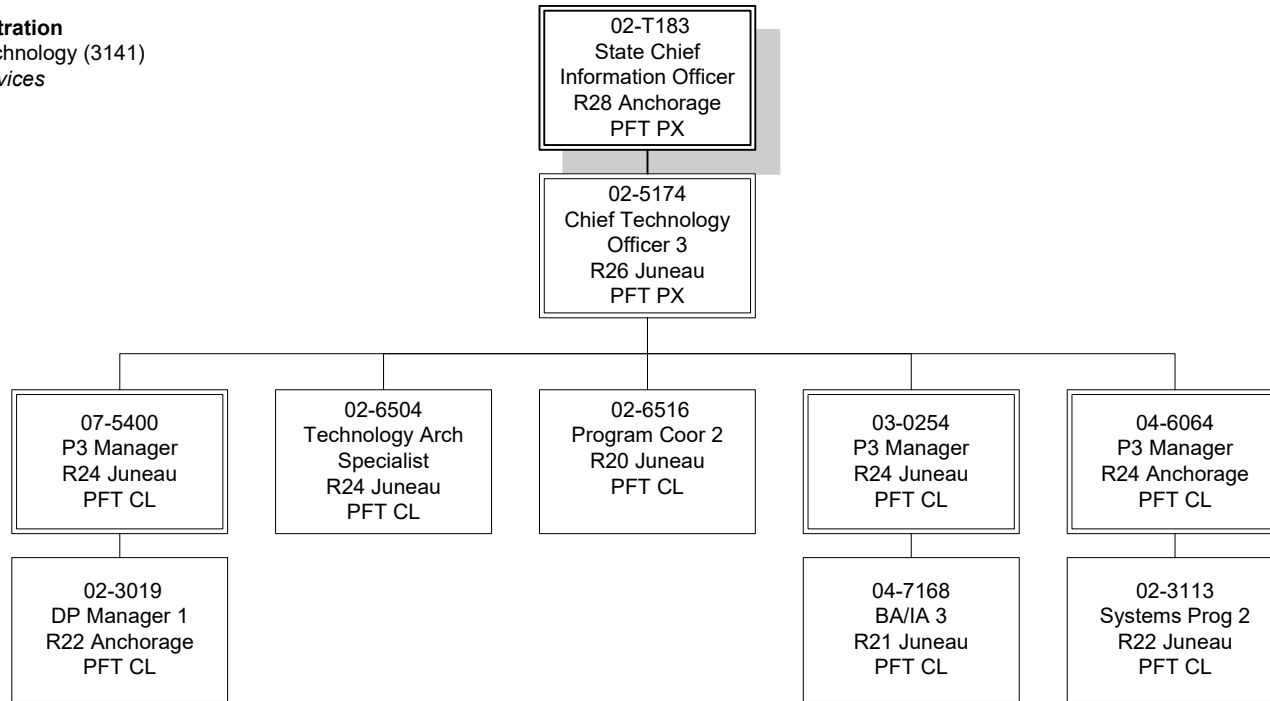

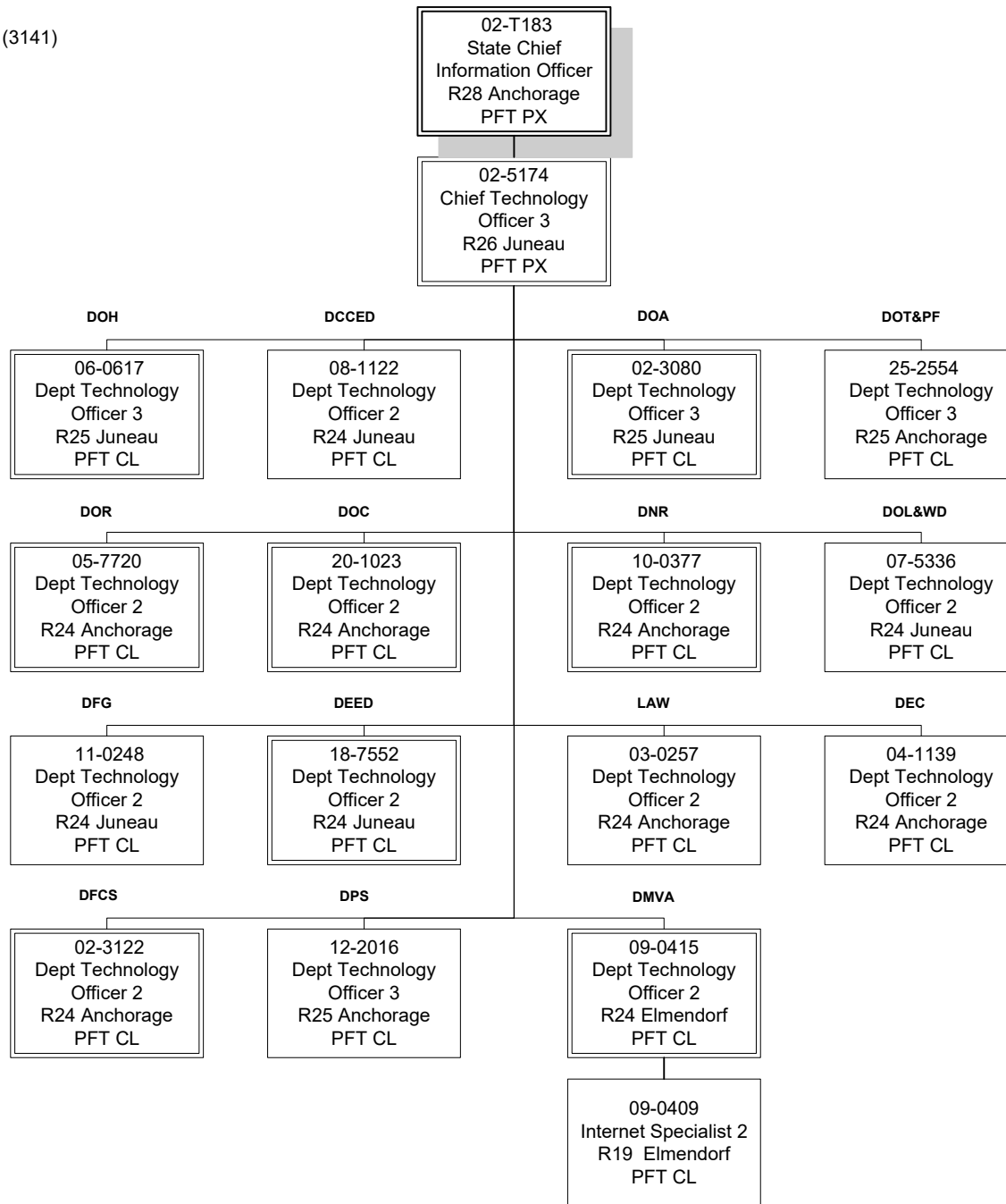

**Department of Administration**  
Alaska Division of Information Technology (3141)  
Service Desk  
Automation & Knowledge Management  
Endpoint Engineering

02-T183  
State Chief  
Information Officer  
R28 Anchorage  
PFT PX

02-6400  
Chief Technology  
Officer 3  
R26 Juneau  
PFT PX

**Service Desk**

**Endpoint  
Engineering**

**Automation & Knowledge  
Management**

02-6614  
DP Prod Manager  
R19 Juneau  
PFT CL

12-4616  
Systems Prog 3  
R23 Juneau  
PFT CL

02-6645  
DP Prod Manager  
R19 Anchorage  
PFT CL

11-1340  
Systems Prog 3  
R23 Juneau  
PFT CL

02-6649  
DP Tech 2  
R15 Juneau  
PFT CL

02-6639  
DP Tech 1/2  
R13/15 Juneau  
PFT CL

03-0228  
Systems Prog 2  
R22 Anchorage  
PFT CL

07-3045  
Systems Prog 2  
R22 Juneau  
PFT CL

02-6624  
DP Tech 2  
R15 Anchorage  
PFT CL

02-6641  
DP Tech 2  
R15 Anchorage  
PFT CL

02-6640  
DP Tech 1/2  
R13/15 Juneau  
PFT CL

07-5490  
DP Tech 2  
R15 Juneau  
PFT CL

07-5016  
DP Tech 2  
R15 Juneau  
PFT CL

02-6642  
DP Tech 1/2  
R13/15 Juneau  
PFT CL

Department of Administration  
 Alaska Division of Information Technology (3141)  
 Service Delivery Group A

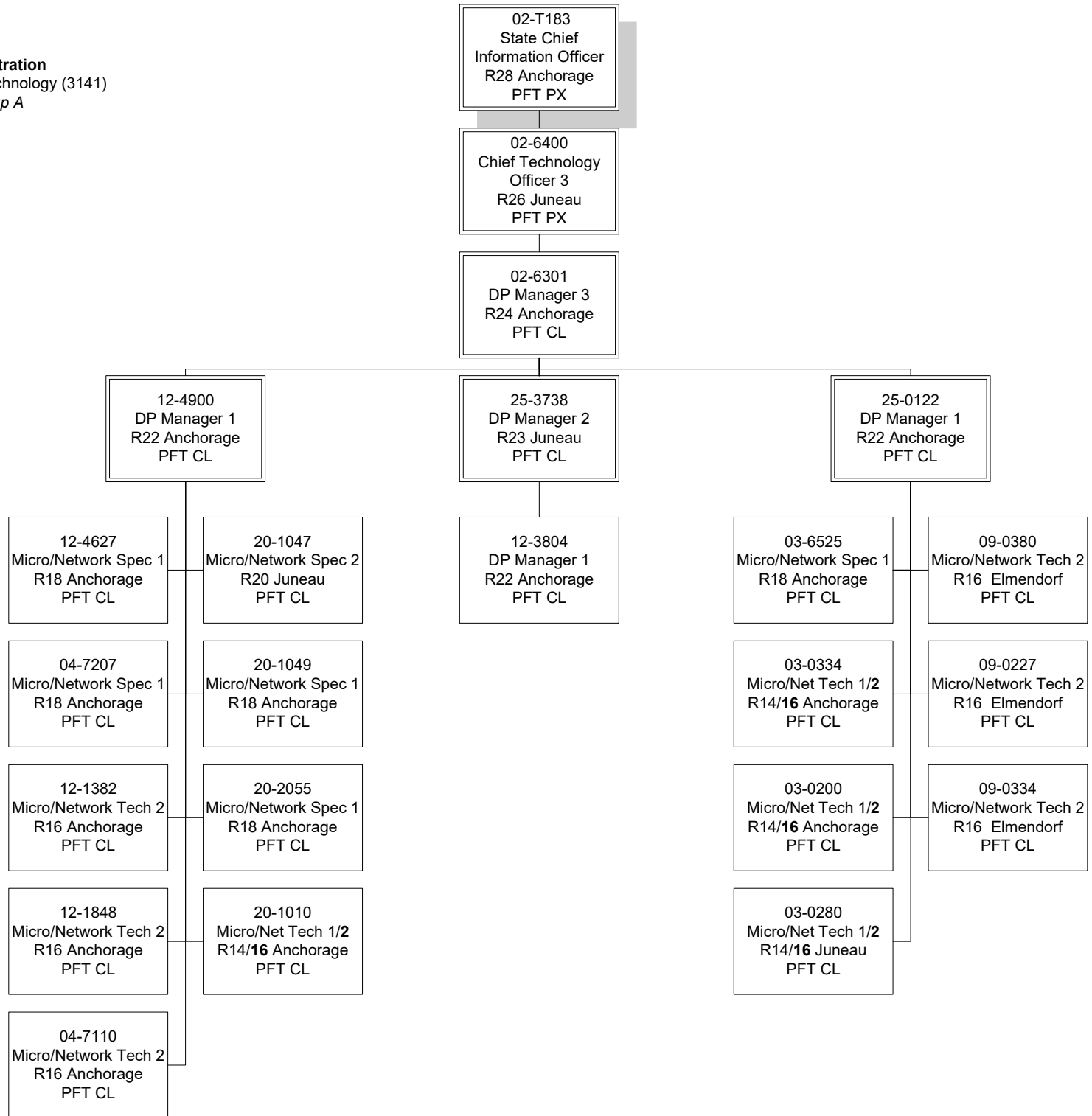

**Department of Administration**  
 Alaska Division of Information Technology (3141)  
 Service Delivery Group B

02-T183  
 State Chief  
 Information Officer  
 R28 Anchorage  
 PFT PX

02-6400  
 Chief Technology  
 Officer 3  
 R26 Juneau  
 PFT PX

02-6301  
 DP Manager 3  
 R24 Anchorage  
 PFT CL

25-3738  
 DP Manager 2  
 R23 Anchorage  
 PFT CL

25-1376  
 DP Manager 1  
 R22 Fairbanks  
 PFT CL

05-7718  
 DP Manager 1  
 R22 Juneau  
 PFT CL

06-0657  
 DP Manager 1  
 R22 Juneau  
 PFT CL

18-7605  
 Micro/Net Spec 1/2  
 R18/20 Fairbanks  
 PFT CL

25-1610  
 Micro/Net Spec 1/2  
 R18/20 Fairbanks  
 PFT CL

25-1462  
 Micro/Net Tech 1/2  
 R14/16 Fairbanks  
 PFT CL

25-2297  
 Micro/Network Spec 1  
 R18 Fairbanks  
 PFT CL

10-0432  
 Micro/Network Tech 2  
 R16 Anchorage  
 PFT CL

25-1561  
 Micro/Net Tech 1/2  
 R14/16 Fairbanks  
 PFT CL

10-0423  
 Micro/Net Tech 1/2  
 R14/16 Palmer  
 PFT CL

02-2095  
 Micro/Network Spec 2  
 R20 Juneau  
 PFT CL

02-1155  
 Micro/Network Spec 1  
 R18 Juneau  
 PFT CL

02-8094  
 Micro/Net Tech 1/2  
 R14/16 Juneau  
 PFT CL

02-1105  
 Micro/Network Spec 2  
 R20 Anchorage  
 PFT CL

04-7068  
 Micro/Net Tech 1/2  
 R14/16 Anchorage  
 PFT CL

04-4035  
 Micro/Network Spec 1  
 R18 Juneau  
 PFT CL

18-7686  
 Micro/Network Spec 2  
 R20 Anchorage  
 PFT CL

10-0283  
 Micro/Network Spec 1  
 R18 Anchorage  
 PFT CL

11-1130  
 Micro/Network Spec 2  
 R20 Fairbanks  
 PFT CL

11-4268  
 Micro/Network Spec 1  
 R18 Anchorage  
 PFT CL

11-1362  
 Micro/Net Tech 1/2  
 R14/16 Anchorage  
 PFT CL

11-2079  
 Micro/Net Tech 1/2  
 R14/16 Anchorage  
 PFT CL

11-1283  
 Micro/Network Spec 2  
 R20 Kodiak  
 PFT CL

11-1678  
 Micro/Network Spec 1  
 R18 Anchorage  
 PFT CL

11-1401  
 Micro/Network Tech 2  
 R16 Juneau  
 PFT CL

11-5013  
 Micro/Net Tech 1/2  
 R14/16 Juneau  
 PFT CL

05-7703  
 Micro/Network Spec 2  
 R20 Anchorage  
 PFT CL

05-7724  
 Micro/Network Spec 1  
 R18 Juneau  
 PFT CL

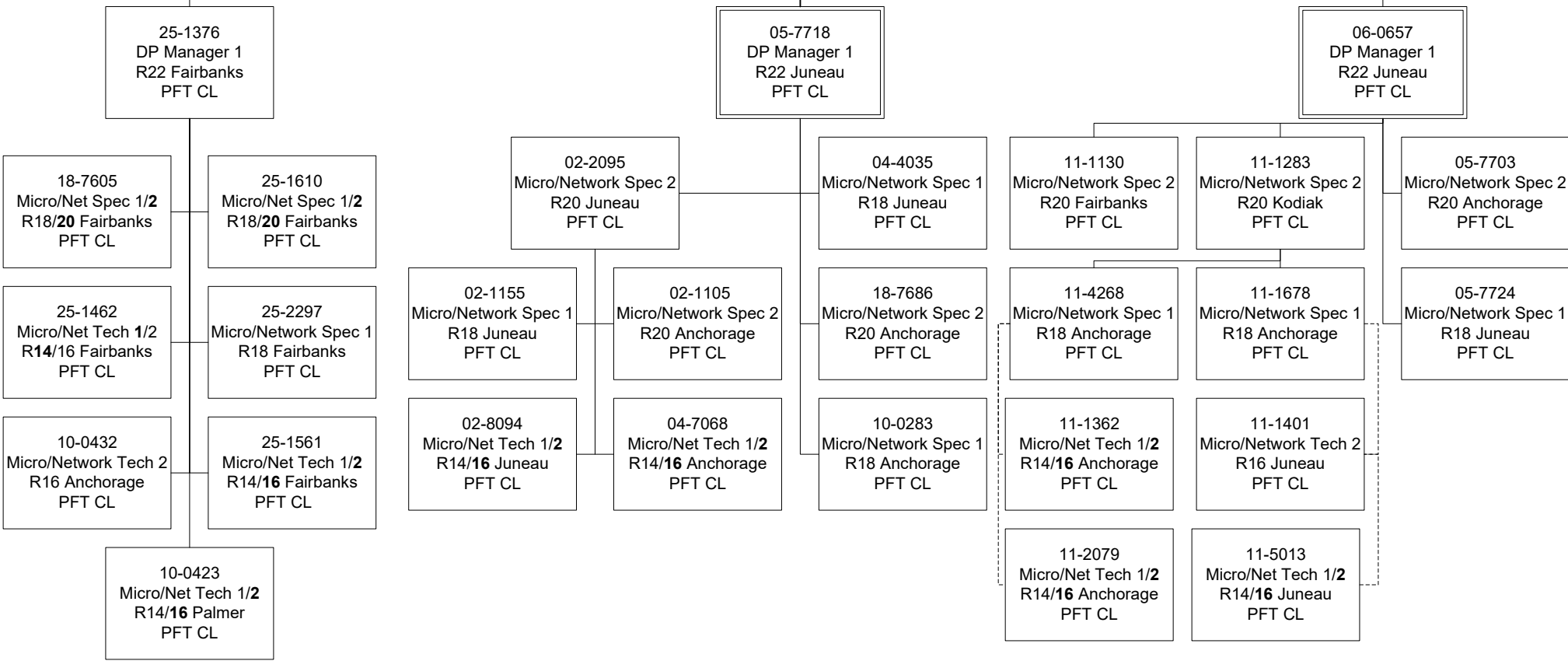

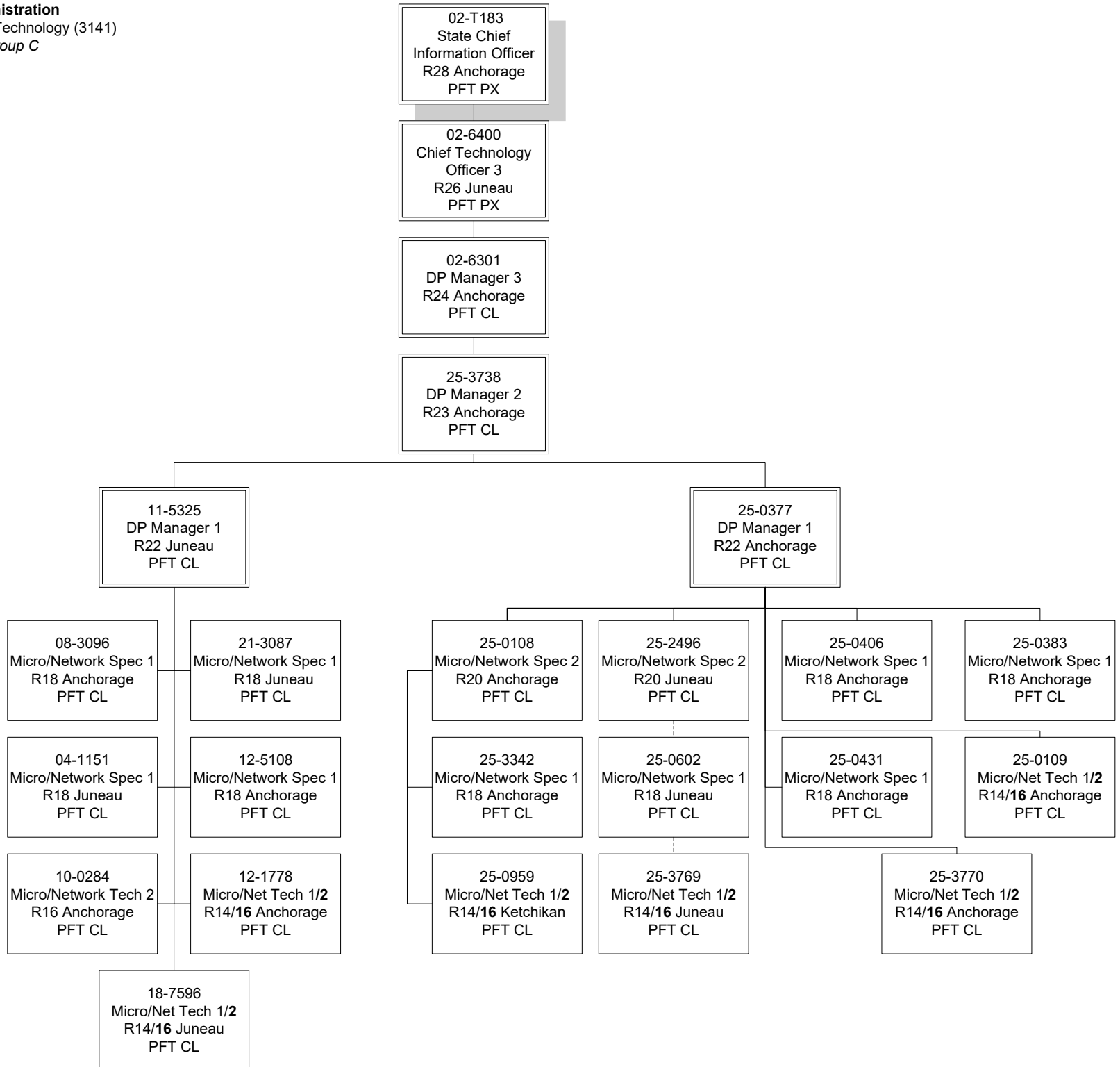



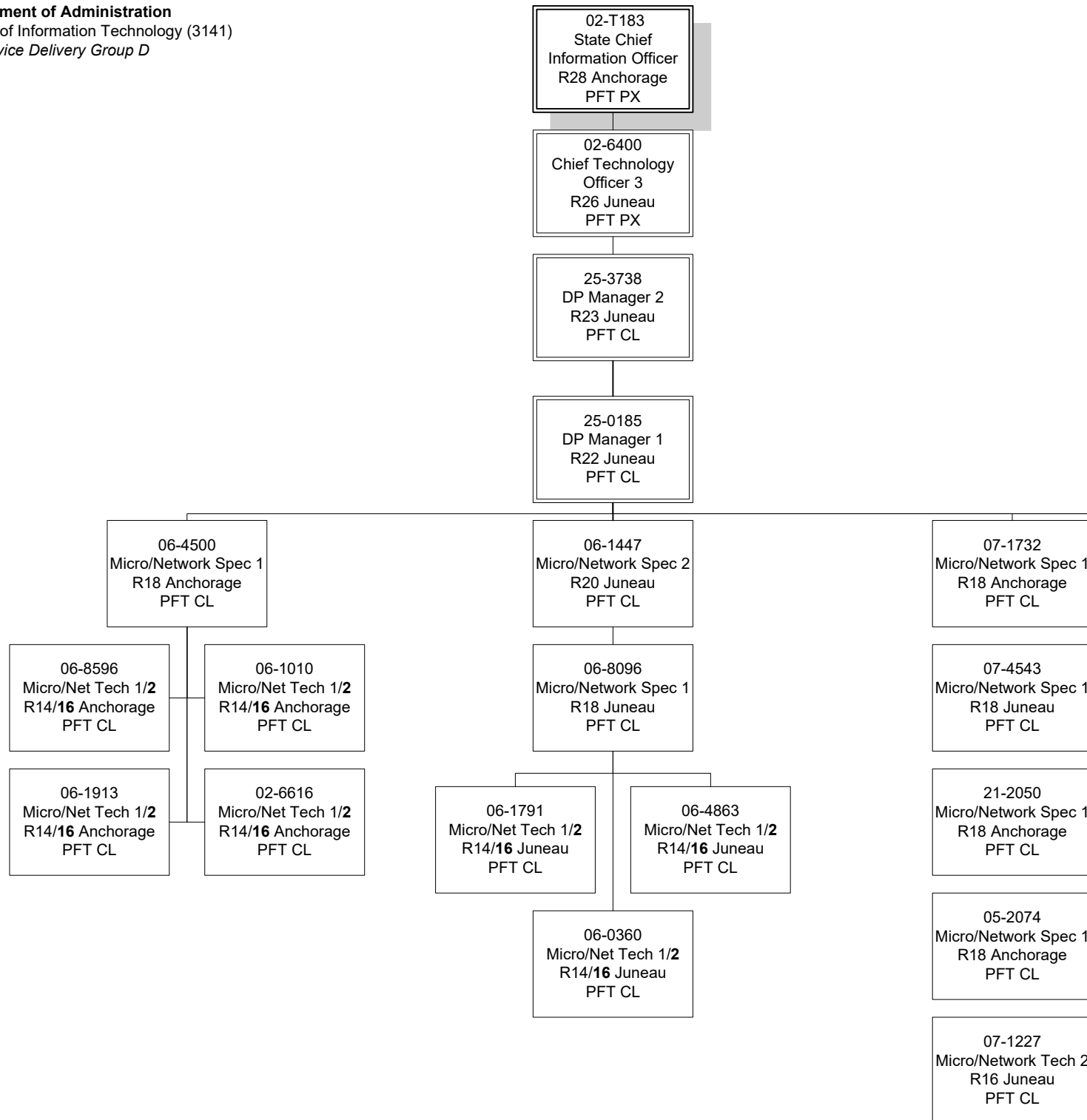

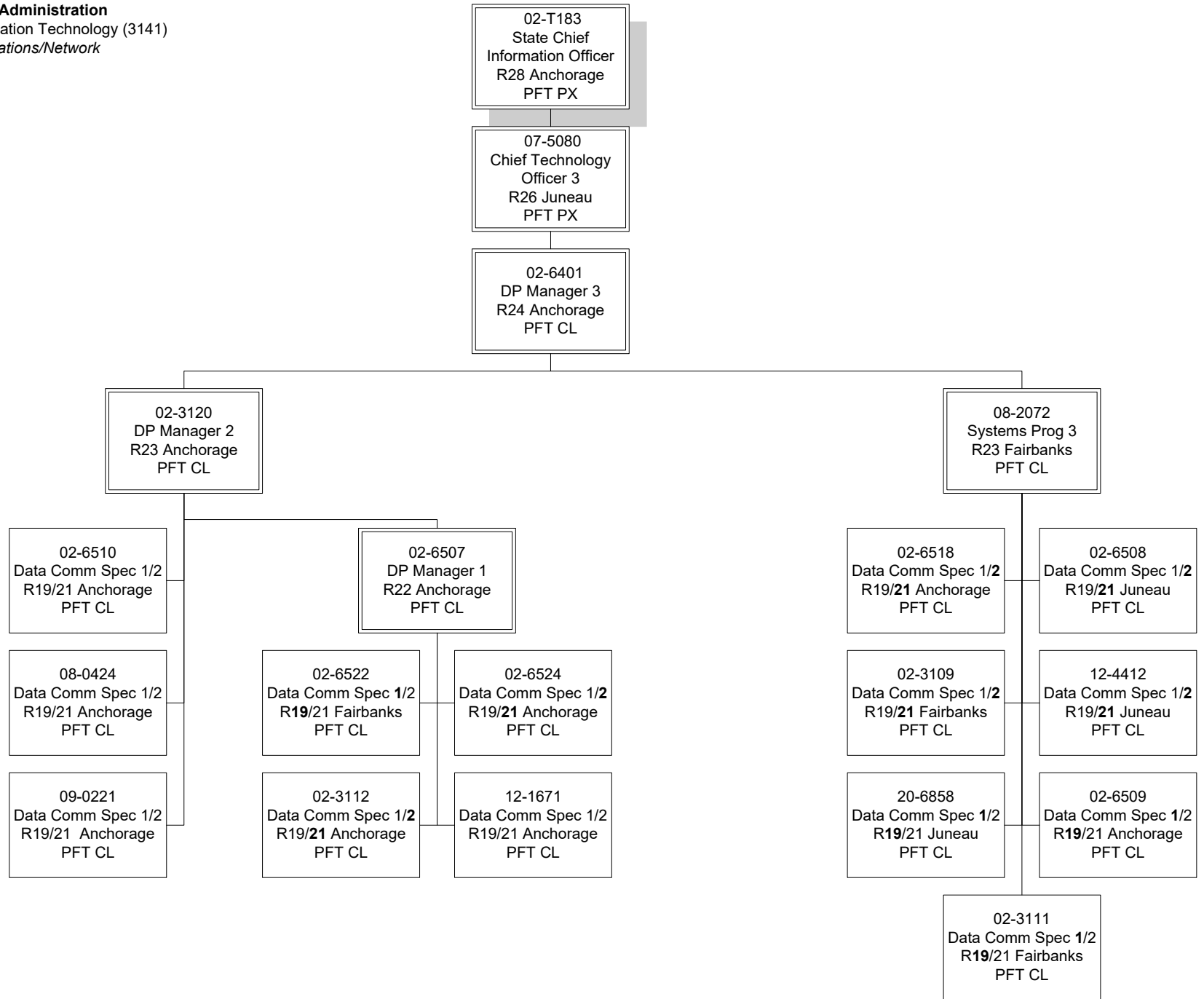

**Department of Administration**  
 Alaska Division of Information Technology (3141)  
*Platform Services*

02-T183  
 State Chief  
 Information Officer  
 R28 Anchorage  
 PFT PX

07-5080  
 Chief Technology  
 Officer 3  
 R26 Juneau  
 PFT PX

02-6601  
 DP Manager 3  
 R24 Anchorage  
 PFT CL

**End Point Server  
 Patch Management**

**Storage, Back Up  
 & Disaster  
 Recovery**

**Cloud  
 Infrastructure**

**Database  
 Services**

**Virtualization &  
 Windows  
 Administration**

18-7543  
 DP Manager 2  
 R23 Anchorage  
 PFT CL

03-0027  
 Systems Prog 3  
 R23 Anchorage  
 PFT CL

18-7043  
 Systems Prog 3  
 R23 Juneau  
 PFT CL

02-6621  
 Database Spec 3  
 R22 Juneau  
 PFT CL

02-3108  
 Systems Prog 3  
 R23 Anchorage  
 PFT CL

03-0118  
 Systems Prog 1/2  
 R20/22 Anchorage  
 PFT CL

02-3114  
 Systems Prog 2  
 R22 Juneau  
 PFT CL

06-1944  
 Systems Prog 2  
 R22 Anchorage  
 PFT CL

02-6511  
 Systems Prog 3  
 R23 Anchorage  
 PFT CL

10-0381  
 Database Spec 3  
 R22 Anchorage  
 PFT CL

02-6314  
 Database Spec 3  
 R22 Juneau  
 PFT CL

02-6610  
 Systems Prog 1/2  
 R20/22 Juneau  
 PFT CL

06-8532  
 Systems Prog 2  
 R22 Anchorage  
 PFT CL

04-1024  
 Systems Prog 1/2  
 R20/22 Fairbanks  
 PFT CL

09-0331  
 Systems Prog 2  
 R22 Elmendorf  
 PFT CL

08-1116  
 Systems Prog 1/2  
 R20/22 Anchorage  
 PFT CL

04-1149  
 Systems Prog 1/2  
 R20/22 Anchorage  
 PFT CL

02-6607  
 Database Spec 1/2/3  
 R20/21/22 Anchorage  
 PFT CL

02-6404  
 Database Spec 1/2/3  
 R20/21/22 Anchorage  
 PFT CL

11-1972  
 Systems Prog 1/2  
 R20/22 Juneau  
 PFT CL

02-6312  
 Systems Prog 2  
 R22 Anchorage  
 PFT CL

06-1580  
 Micro/Network Spec 2  
 R20 Anchorage  
 PFT CL

12-1717  
 Systems Prog 1  
 R20 Anchorage  
 PFT CL

10-0407  
 Systems Prog 1/2  
 R20/22 Anchorage  
 PFT CL

06-3974  
 Database Spec 1/2/3  
 R20/21/22 Juneau  
 PFT CL

06-2283  
 Database Spec 1/2/3  
 R20/21/22 Juneau  
 PFT CL

11-0225  
 System Prog 1  
 R20 Anchorage  
 PFT CL

09-0303  
 Micro/Network Spec 2  
 R20 Elmendorf  
 PFT CL

08-1119  
 Micro/Network Spec 2  
 R20 Anchorage  
 PFT CL

**Department of Administration**  
Alaska Division of Information Technology (3141)  
*Application Services*

02-T183  
State Chief  
Information Officer  
R28 Anchorage  
PFT PX

07-5080  
Chief Technology  
Officer 3  
R26 Juneau  
PFT PX

02-6605  
Systems Prog 4  
R25 Anchorage  
PFT CL

**ID Mgmt & Directories**

**Unix-Solaris-  
Linux**

**SP/Web Content**

**Enterprise & PFT  
CLpport Apps**

**Internal Svcs  
PFT CLpport**

**O365/PFT Cloud**

25-2938  
Systems Prog 3  
R23 Juneau  
PFT CL

02-6418  
Systems Prog 2  
R22 Juneau  
PFT CL

02-1035  
Internet Specialist 2  
R19 Juneau  
PFT CL

02-6408  
Systems Prog 3  
R23 Anchorage  
PFT CL

02-6617  
Analyst/Prog 5  
R22 Juneau  
PFT CL

02-6647  
Systems Prog 3  
R23 Juneau  
PFT CL

08-0415  
Systems Prog 1/2  
R20/22 Anchorage  
PFT CL

07-5023  
Systems Prog 2  
R22 Juneau  
PFT CL

02-9001  
Systems Prog 2  
R22 Anchorage  
PFT CL

02-6502  
Systems Prog 2  
R22 Anchorage  
PFT CL

02-6415  
Systems Prog 1/2  
R20/22 Anchorage  
PFT CL

02-6523  
Systems Prog 1/2  
R20/22 Anchorage  
PFT CL

18-7430  
Systems Prog 1/2  
R20/22 Anchorage  
PFT CL

02-5148  
Systems Prog 1  
R20 Juneau  
PFT CL

10-0391  
Analyst/Prog 4  
R20 Anchorage  
PFT CL

02-0013  
Systems Prog 1/2  
R20/22 Anchorage  
PFT CL

06-4066  
Systems Prog 1/2  
R20/22 Juneau  
PFT CL

02-6304  
Systems Prog 2  
R22 Anchorage  
PFT CL

