

Department of Fish & Game
 2167 - Southeast Region Fisheries Management
 FY2024 Governor Budget

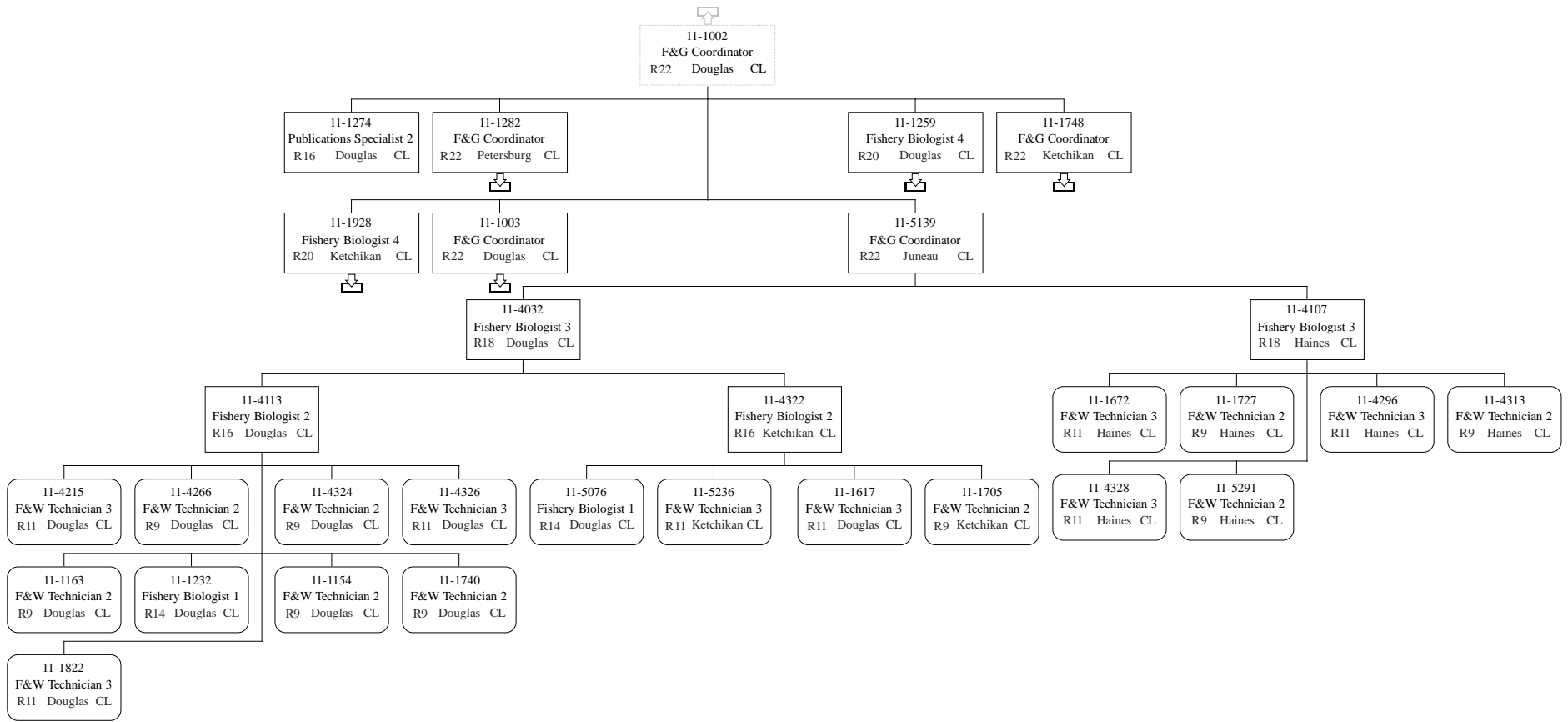

Department of Fish & Game
 2167 - Southeast Region Fisheries Management
 FY2024 Governor Budget

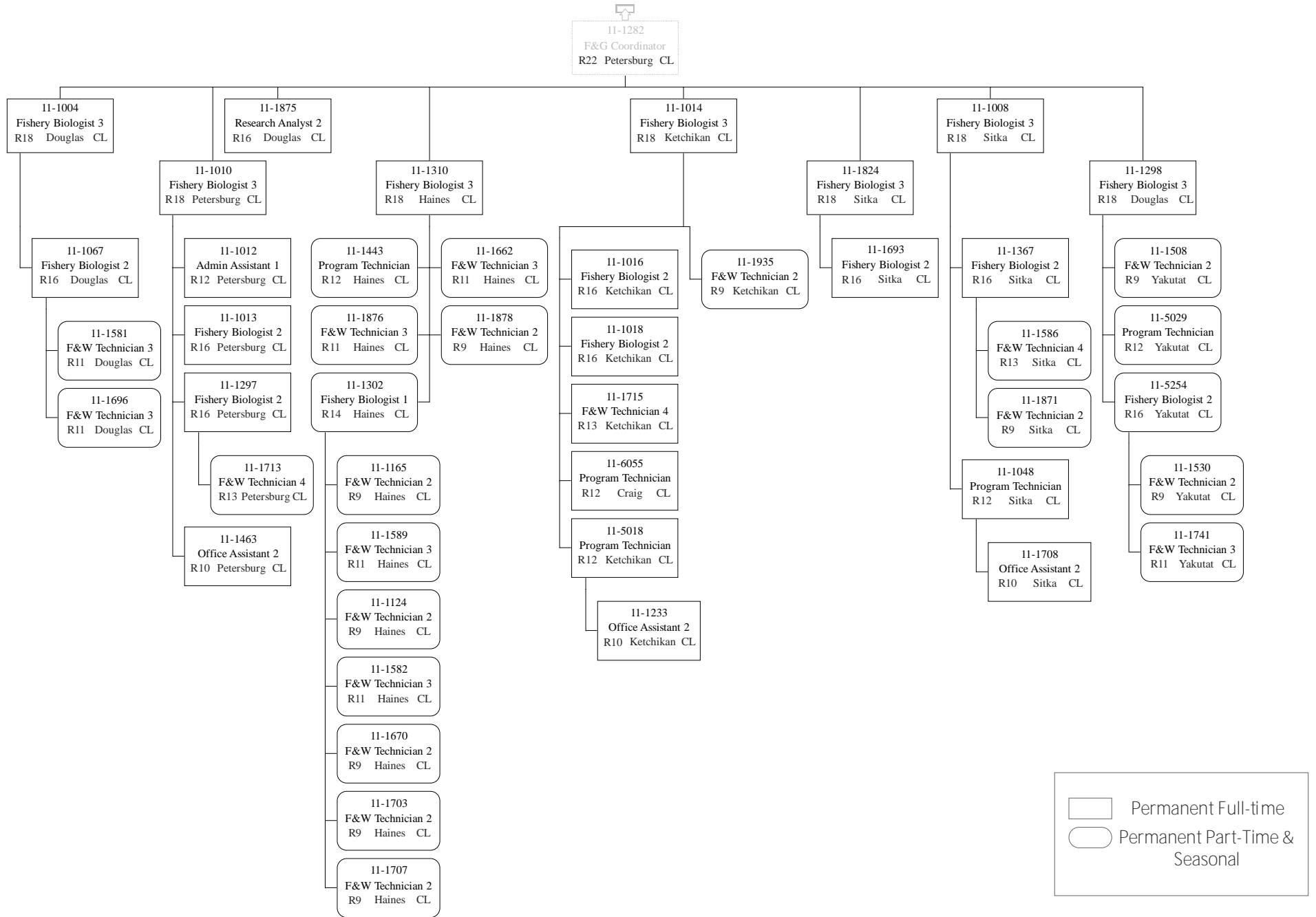

Permanent Full-time
 Permanent Part-Time & Seasonal

Department of Fish & Game
2167 - Southeast Region Fisheries Management
FY2024 Governor Budget

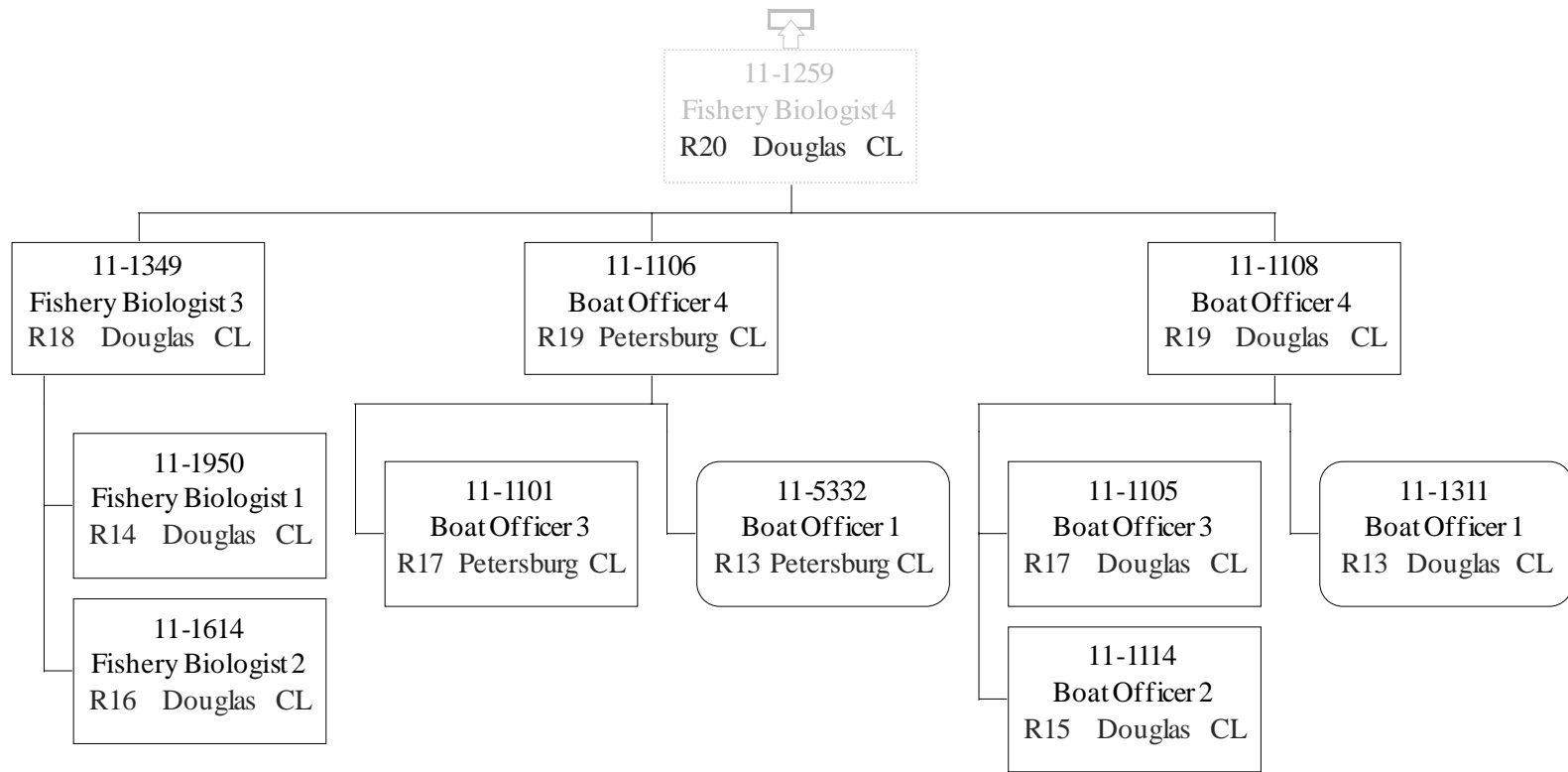

Department of Fish & Game
 2167 - Southeast Region Fisheries Management
 FY2024 Governor Budget

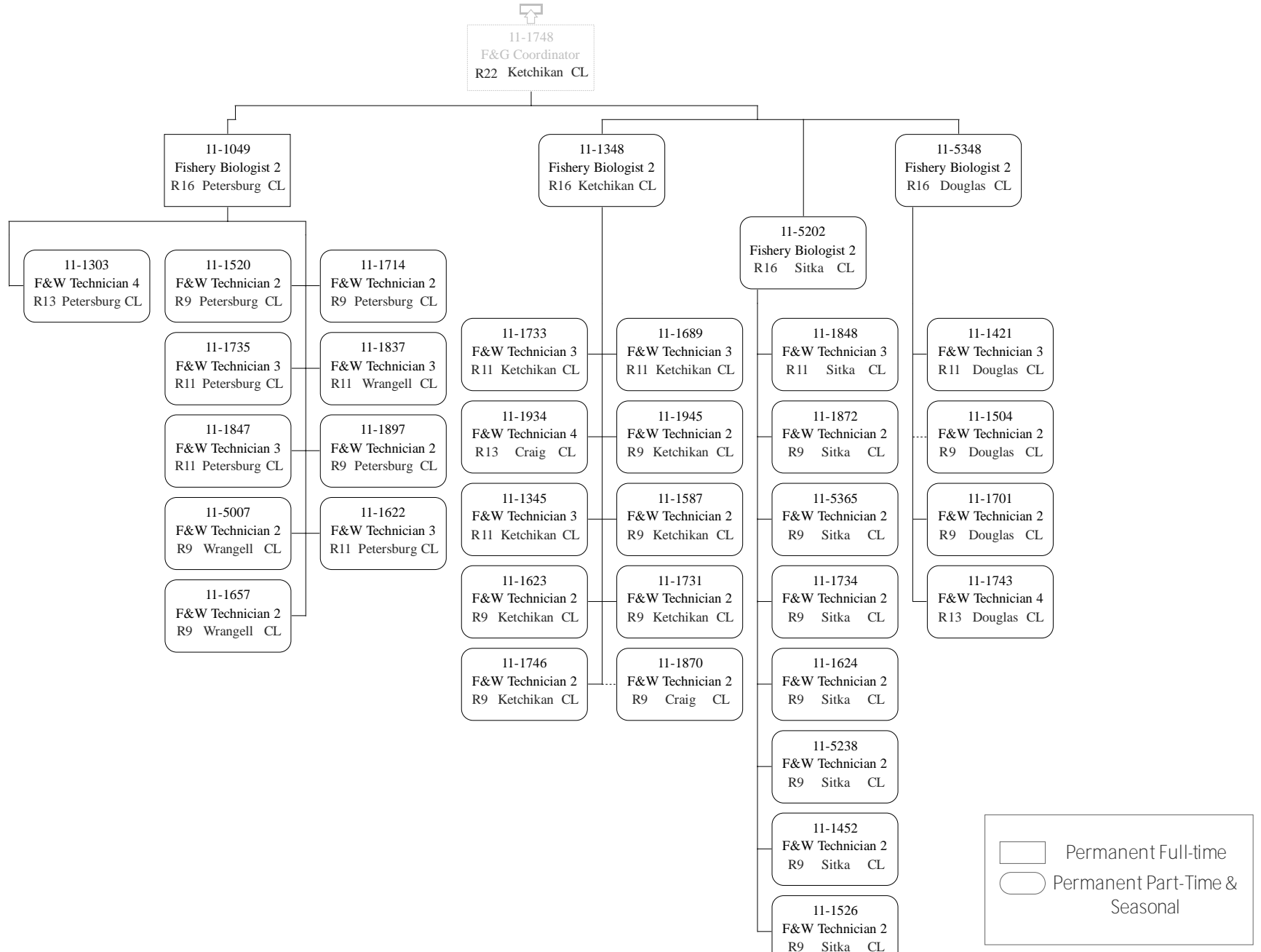

Permanent Full-time
 Permanent Part-Time & Seasonal

Department of Fish & Game
 2167 - Southeast Region Fisheries Management
 FY2024 Governor Budget

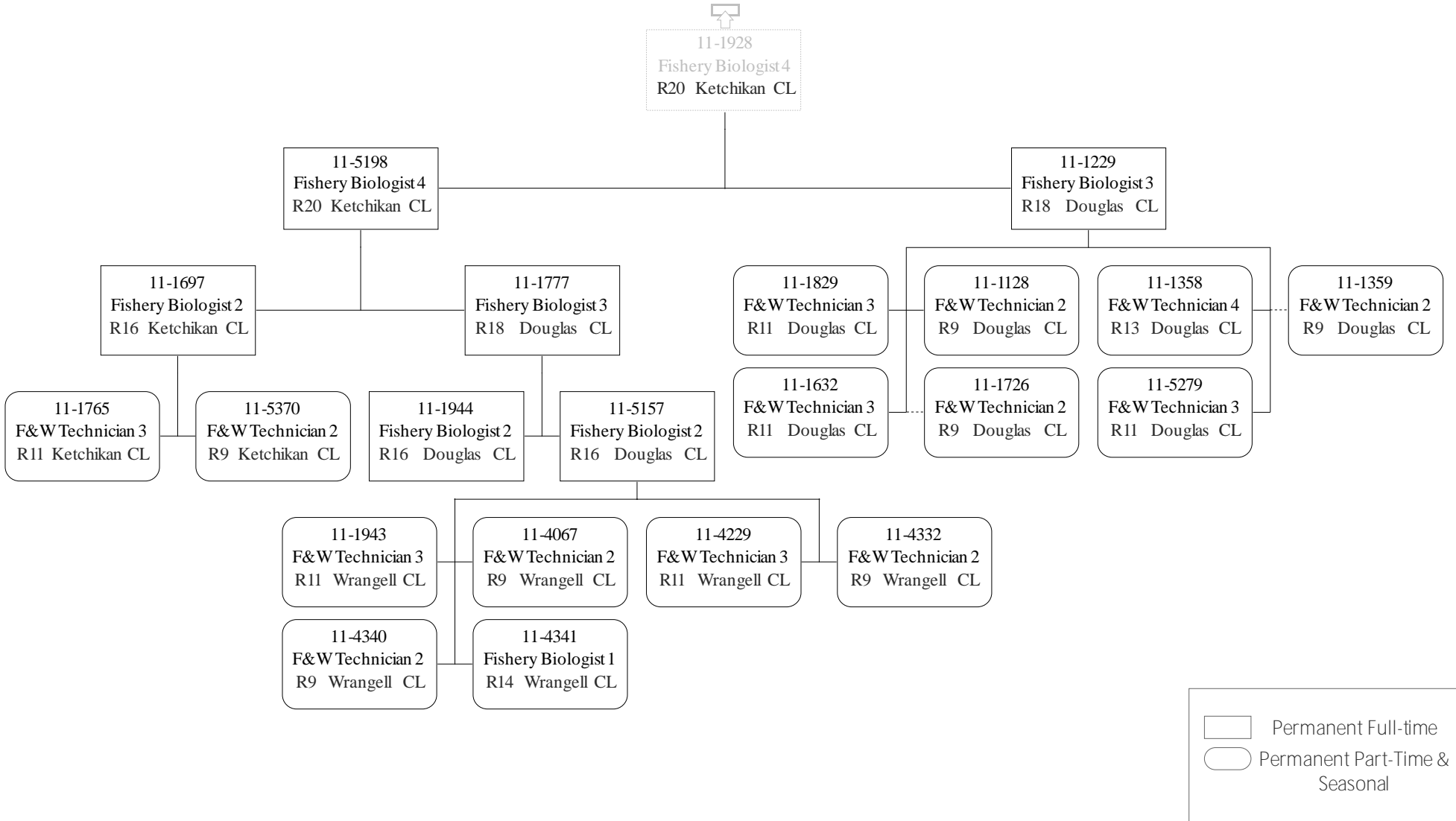

Department of Fish & Game
2167 - Southeast Region Fisheries
Management FY2024 Governor Budget

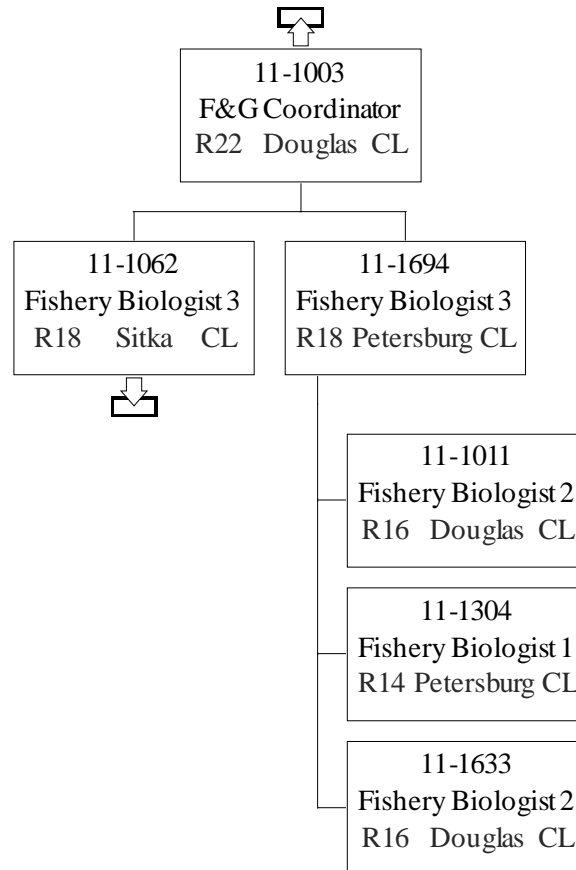

Department of Fish & Game
2167 - Southeast Region Fisheries Management
FY2024 Governor Budget

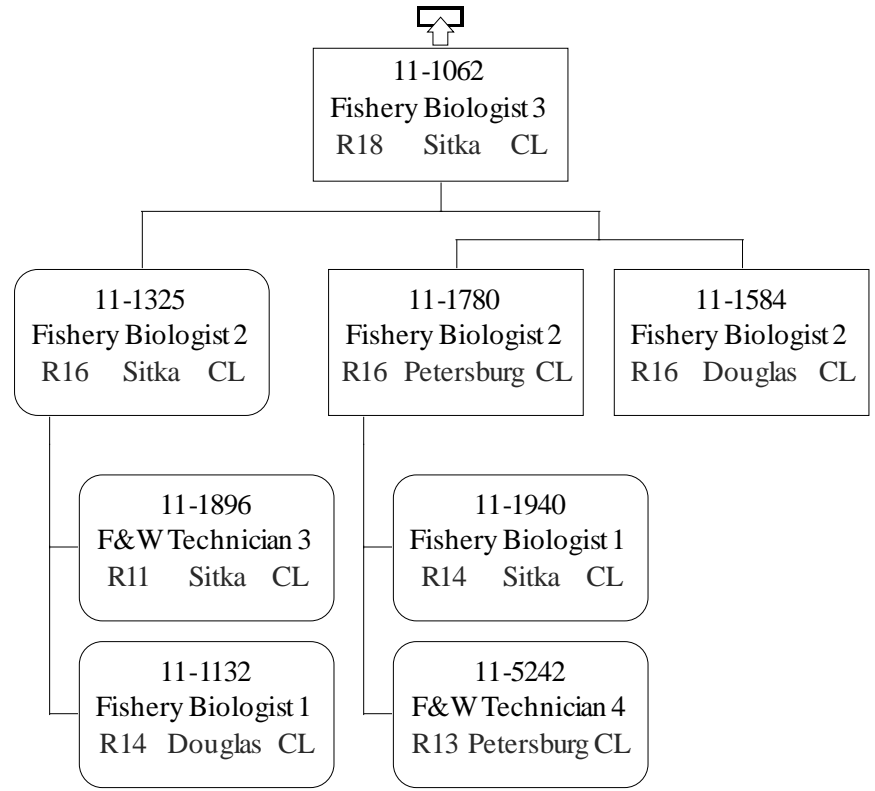

Department of Fish & Game
2167 - Southeast Region Fisheries Management
FY2024 Governor Budget

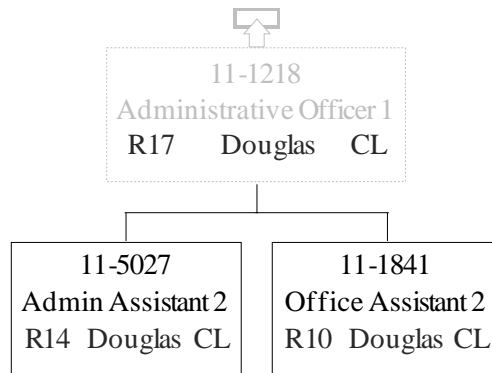

Department of Fish and Game
2167 – Southeast Region Fisheries Management
FY2024 Governor Budget

11-5157
Fishery Biologist 2
R16 Douglas CL

11-7002
F&G Program Technician
R12 Wrangell CL

11-1835
Accounting Technician 3
16 Douglas CL

11-1324
Accounting Tech 1
R12 Douglas CL

11-1951
Accounting Clerk
R10 Douglas CL

11-1129
Analyst/Programmer 5
R22 Juneau CL

11-1821
Analyst/Programmer 4
R20 Douglas CL