

Department of Fish & Game
2168 - Central Region Fisheries Management
FY2024 Governor Budget

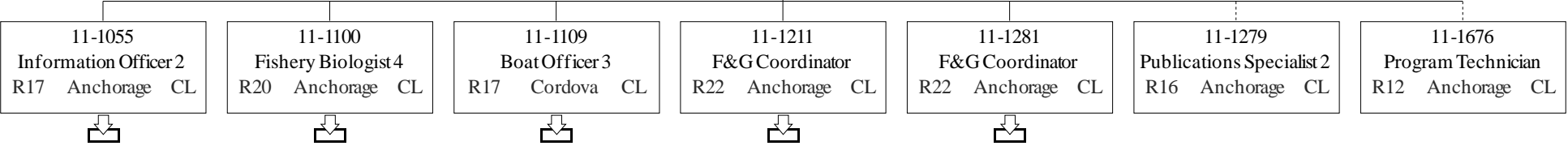

Department of Fish & Game
2168 - Central Region Fisheries Management
FY2024 Governor Budget



11-1055
Information Officer 2
R17 Anchorage CL

	Permanent Full-time
	Permanent Part-Time & Seasonal

Department of Fish & Game
 2168 - Central Region Fisheries Management
 FY2024 Governor Budget

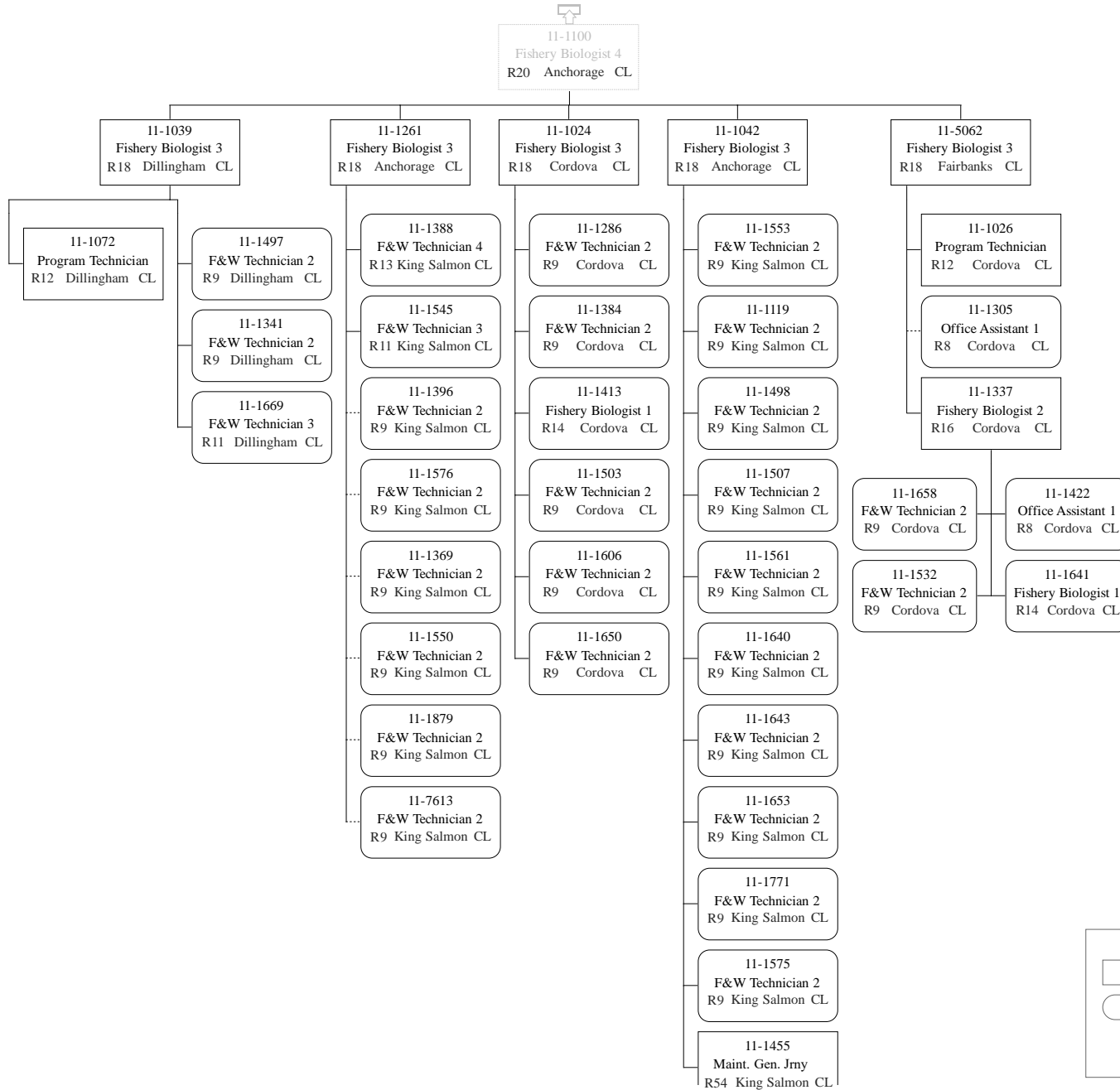

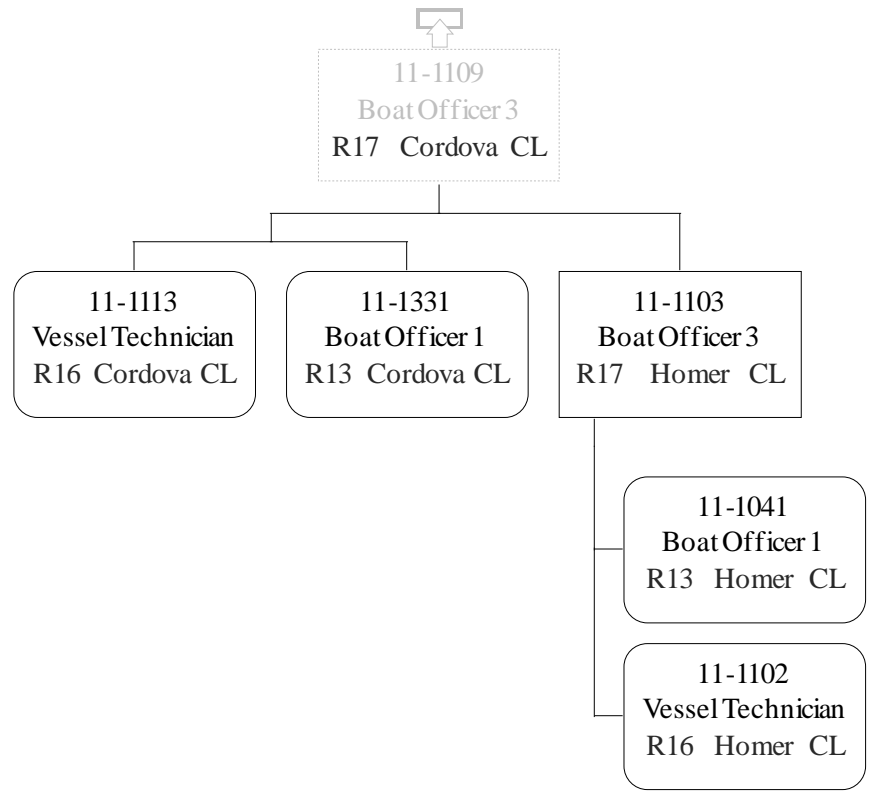

Department of Fish & Game
 2168 - Central Region Fisheries Management
 FY2024 Governor Budget

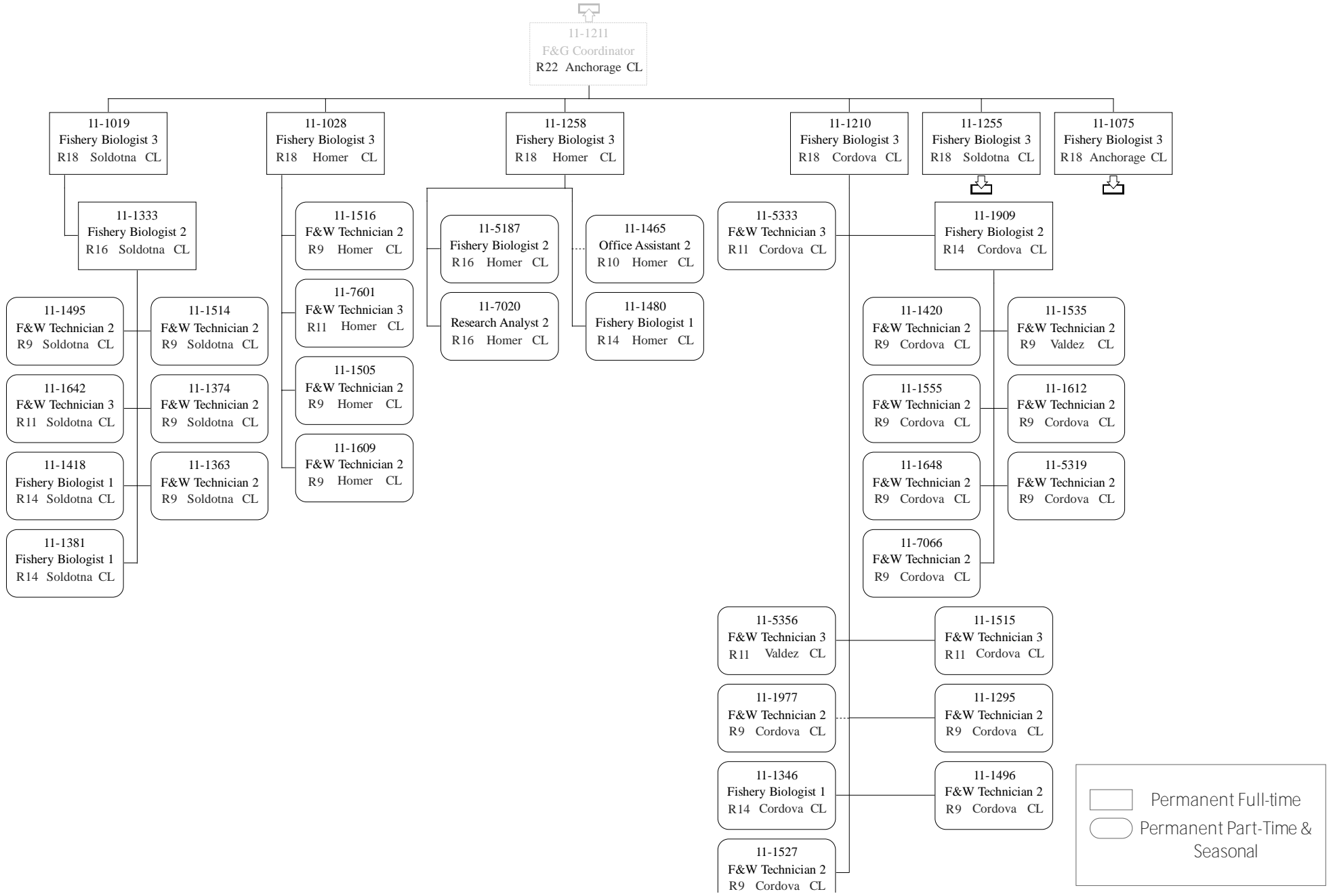

Permanent Full-time
 Permanent Part-Time & Seasonal

Department of Fish & Game
 2168 - Central Region Fisheries Management
 FY2024 Governor Budget

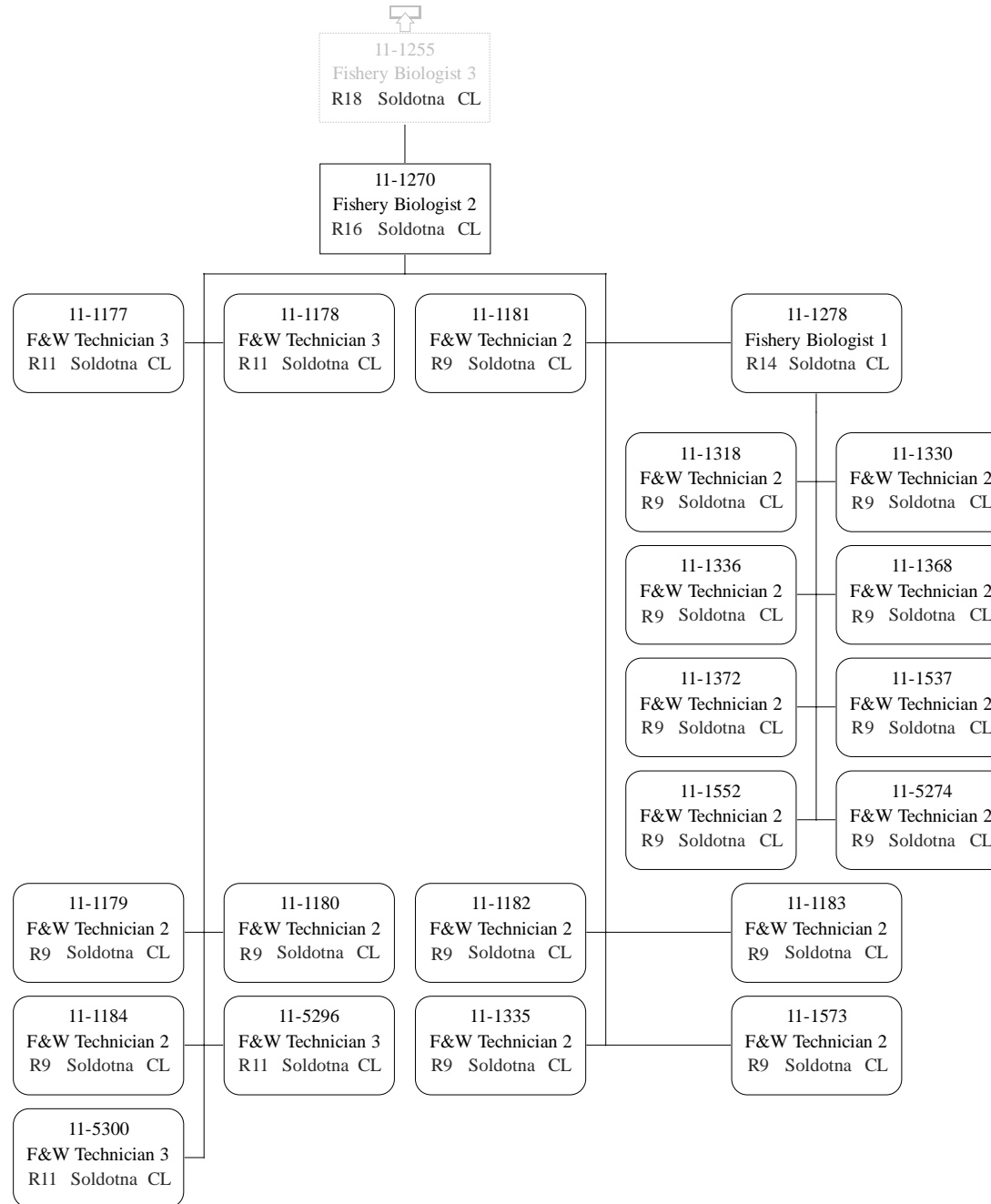

Department of Fish & Game
 2168 - Central Region Fisheries Management
 FY2024 Governor Budget

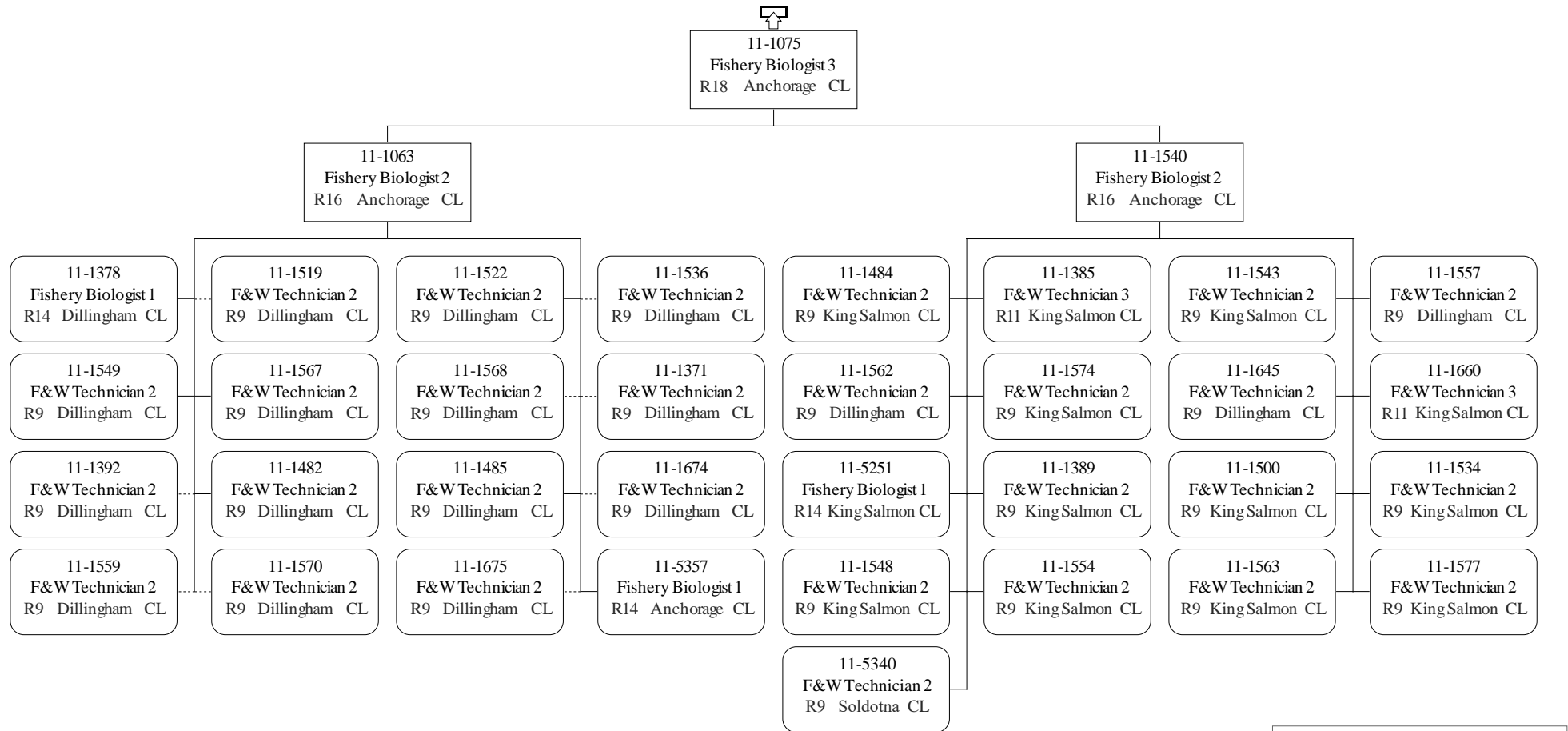

Department of Fish & Game
 2168 - Central Region Fisheries Management
 FY2024 Governor Budget

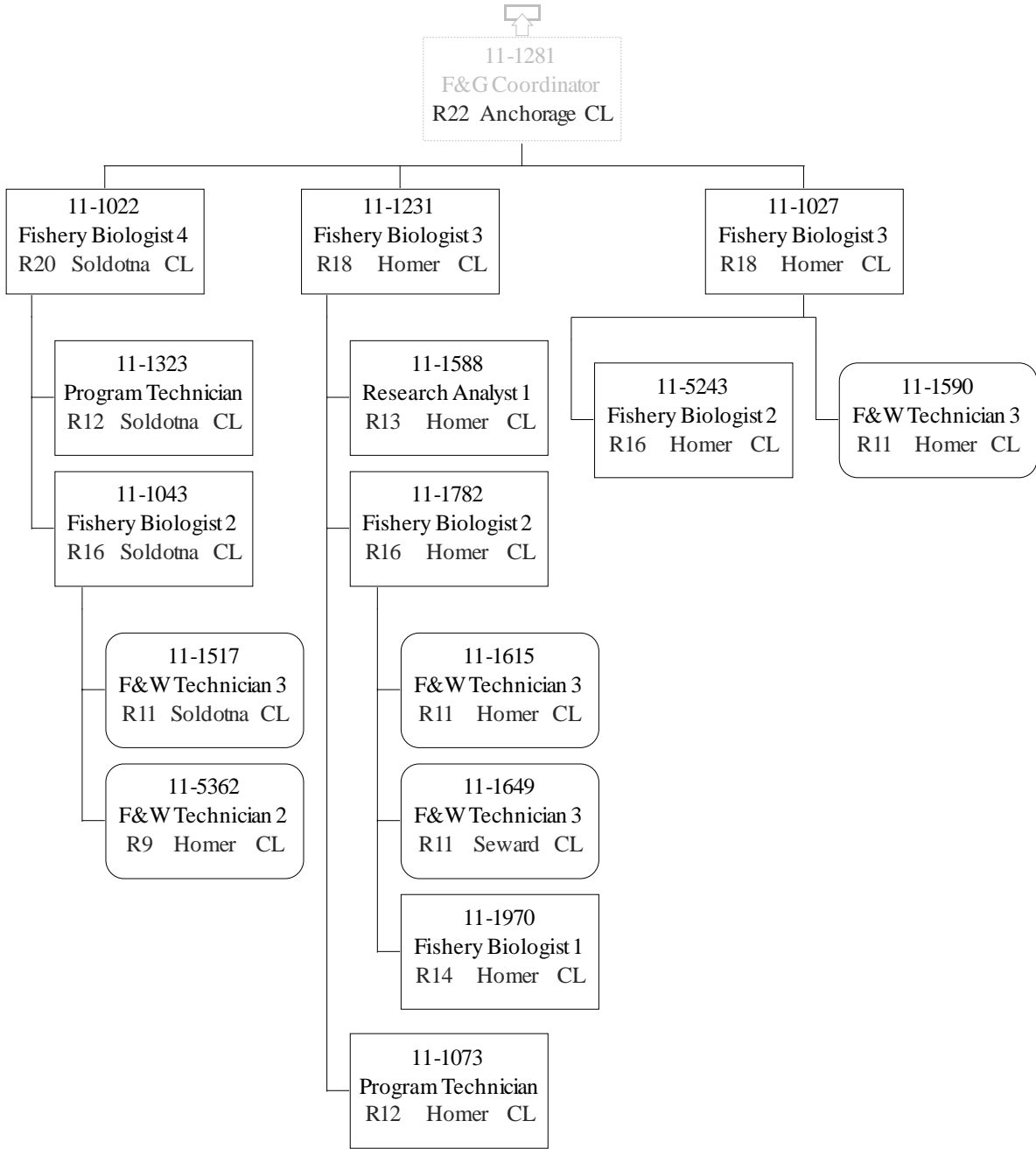

Department of Fish & Game 2168 -
Central Region Fisheries Management
FY2024 Governor Budget

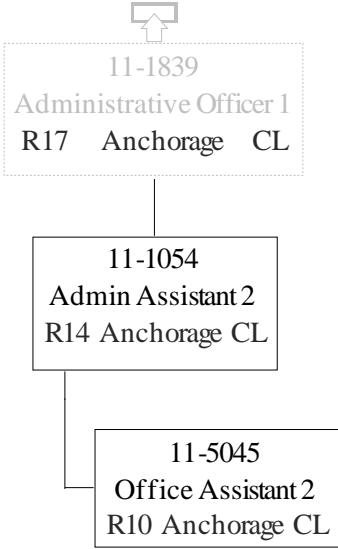

Department of Fish and Game
2168 – Central Region Fisheries Management
FY2024 Governor Budget

