

FY2024 Governor
 Department of Health
 Senior and Disabilities Services
 Senior and Disabilities Services Administration

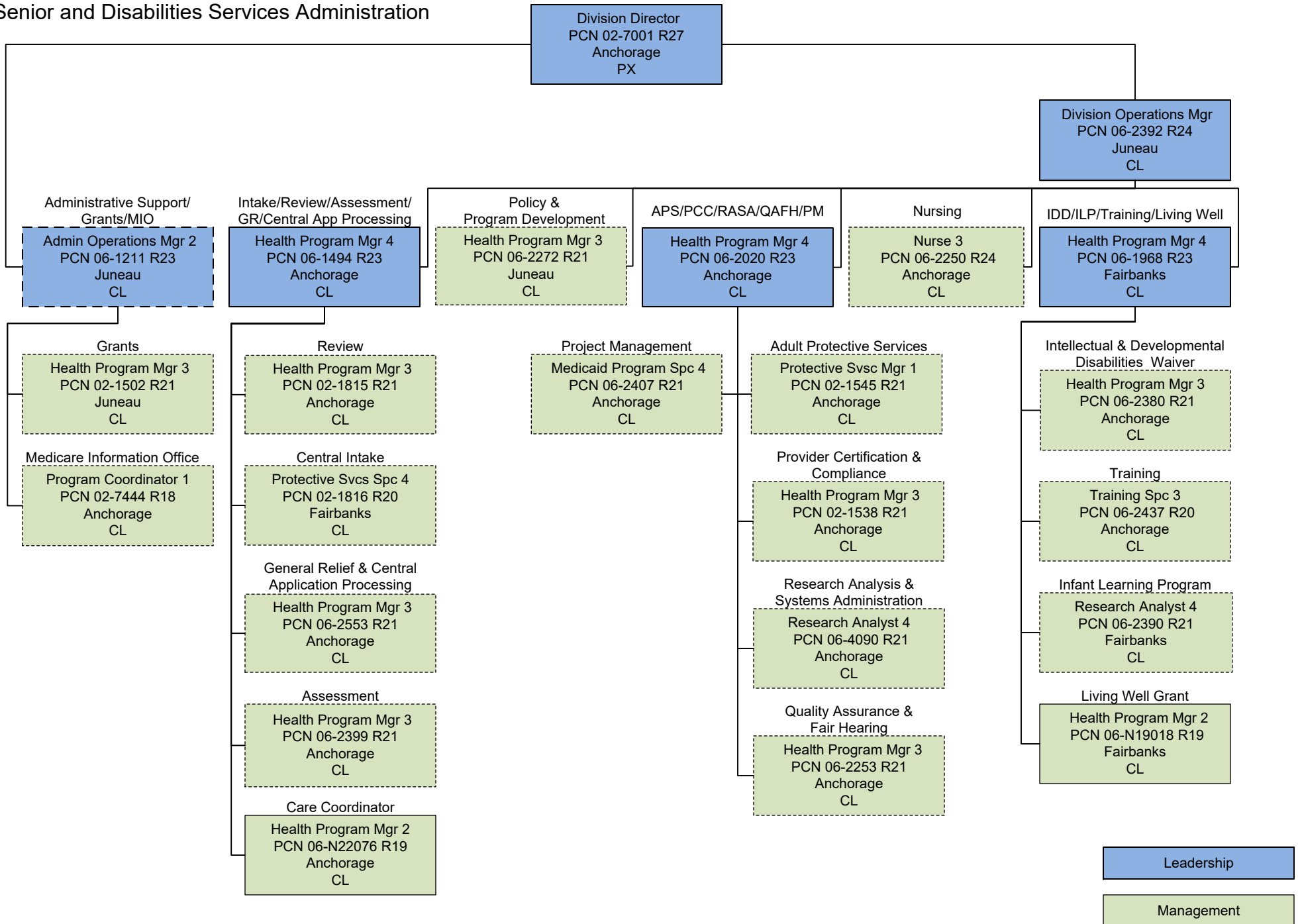

FY2024 Governor
 Department of Health
 Senior and Disabilities Services
 Senior and Disabilities Services Administration
 Quality Assurance and Fair Hearing

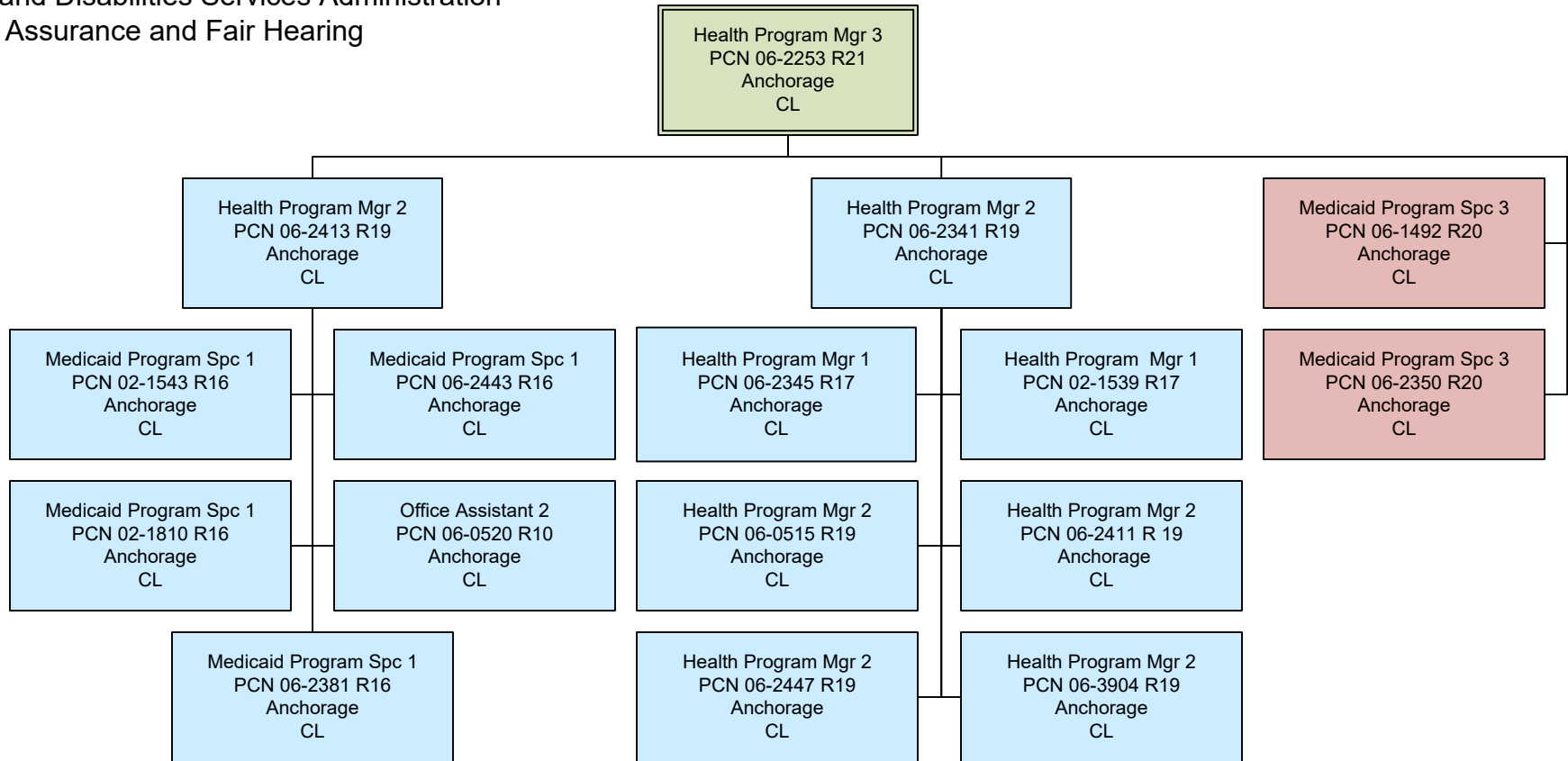

Fair Hearing

Quality Assurance

FY2024 Governor
Department of Health
Senior and Disabilities Services
Senior and Disabilities Services Administration
Provider Certification and Compliance

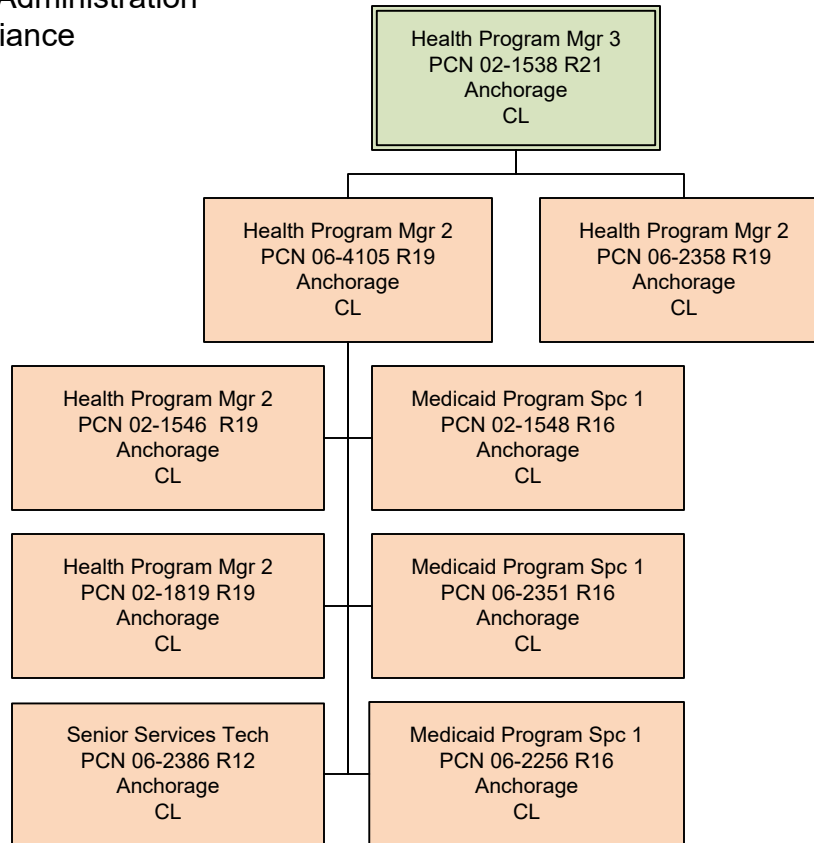

FY2024 Governor
Department of Health
Senior and Disabilities Services
Senior and Disabilities Services Administration
Research and Analysis
Systems Administration

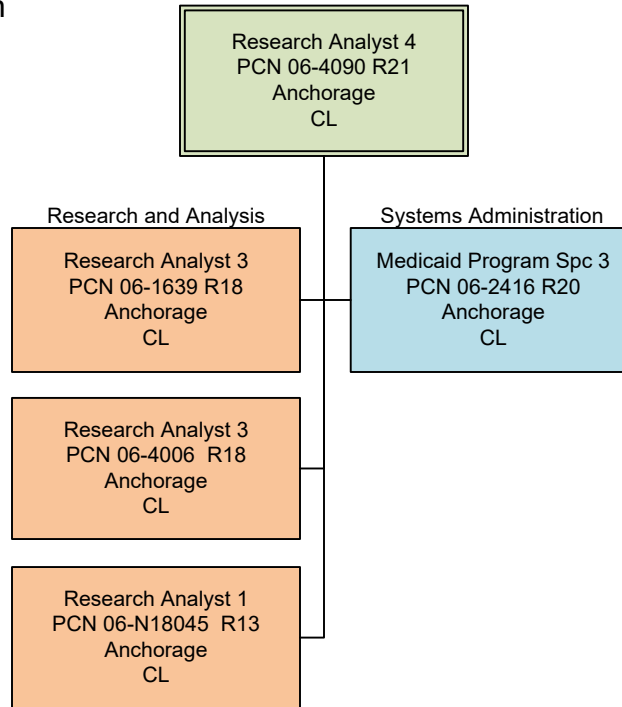

Research and Analysis

Systems Administration

FY2024 Governor
Department of Health
Senior and Disabilities Services
Senior and Disabilities Services Administration
Central Intake

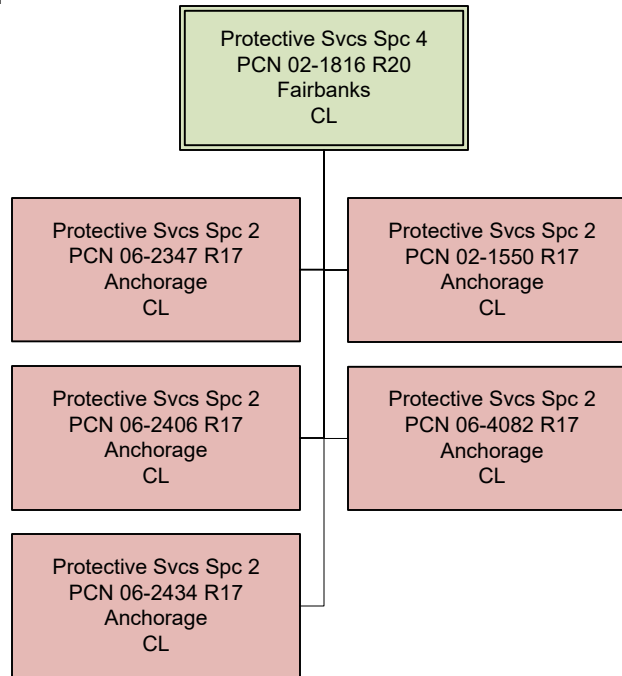

FY2024 Governor
Department of Health
Senior and Disabilities Services
Senior and Disabilities Services Administration
Adult Protective Services

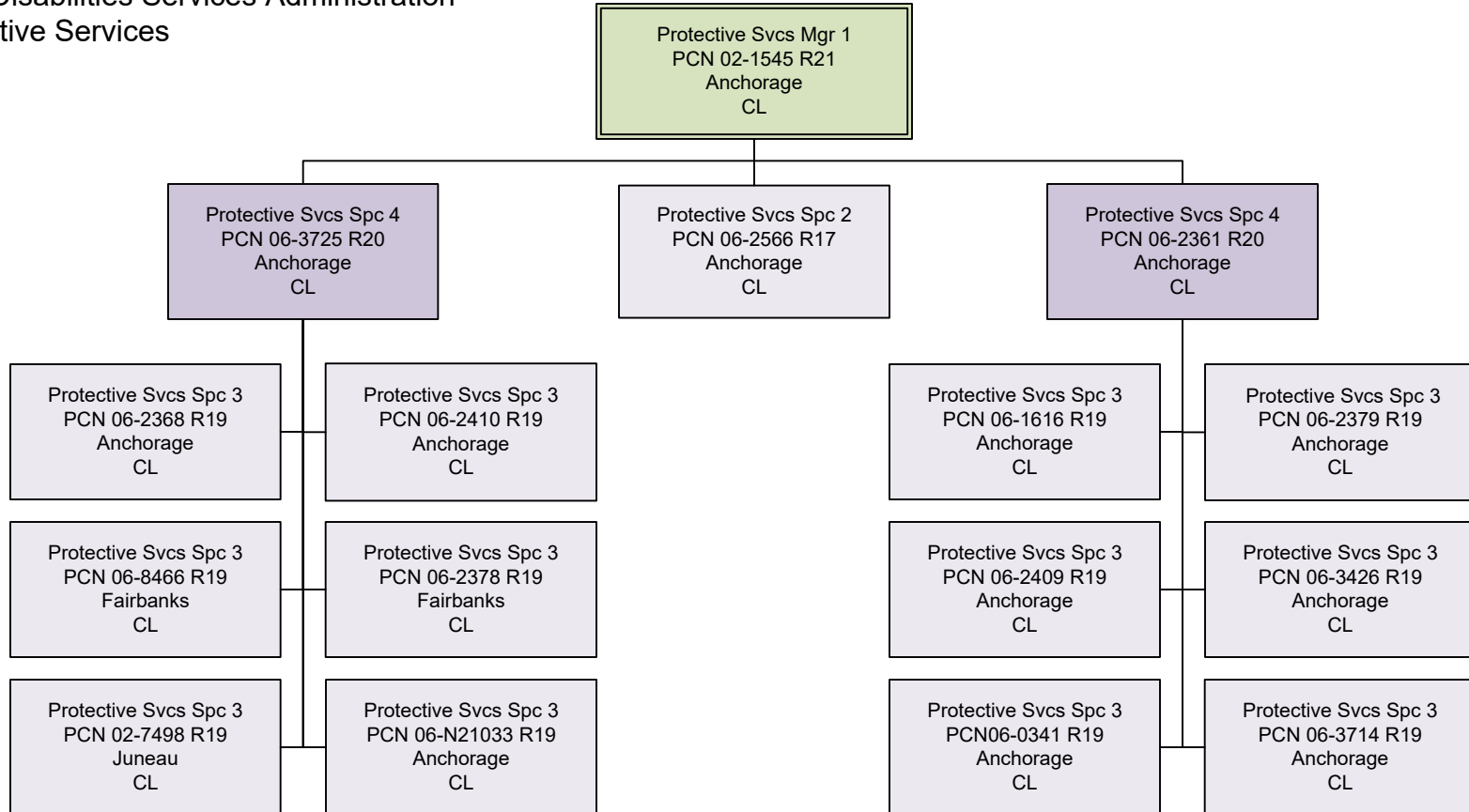

FY2024 Governor
Department of Health
Senior and Disabilities Services
Senior and Disabilities Services Administration
General Relief and Central Application Processing

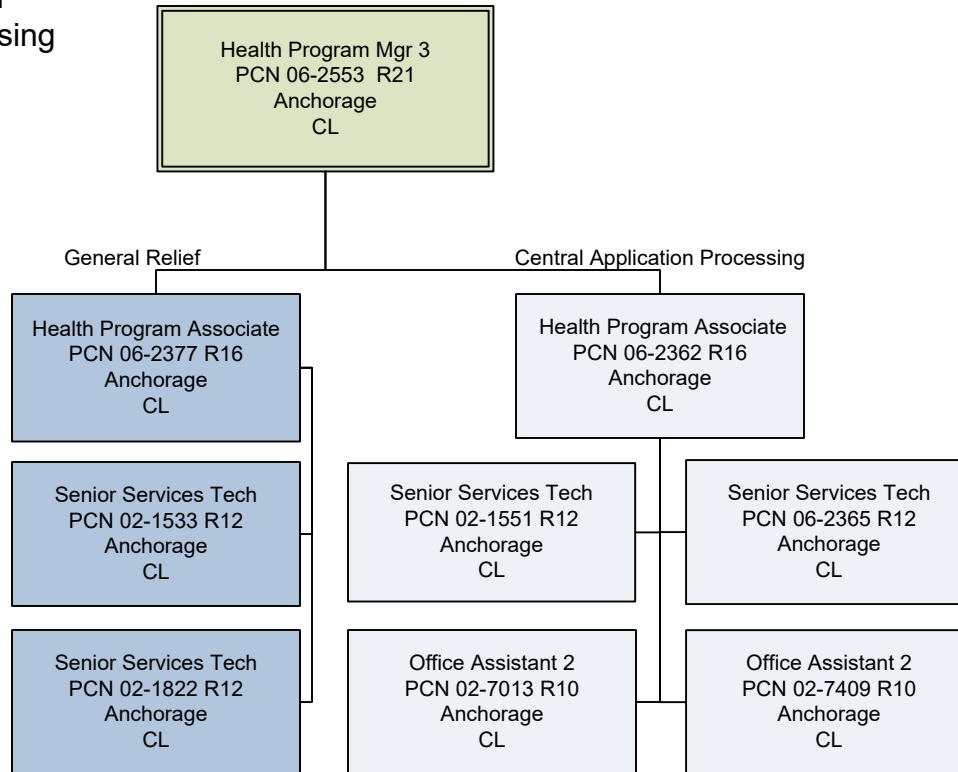

General Relief

Central Application Processing

FY2024 Governor
Department of Health
Senior and Disabilities Services
Senior and Disabilities Services Administration
Nursing

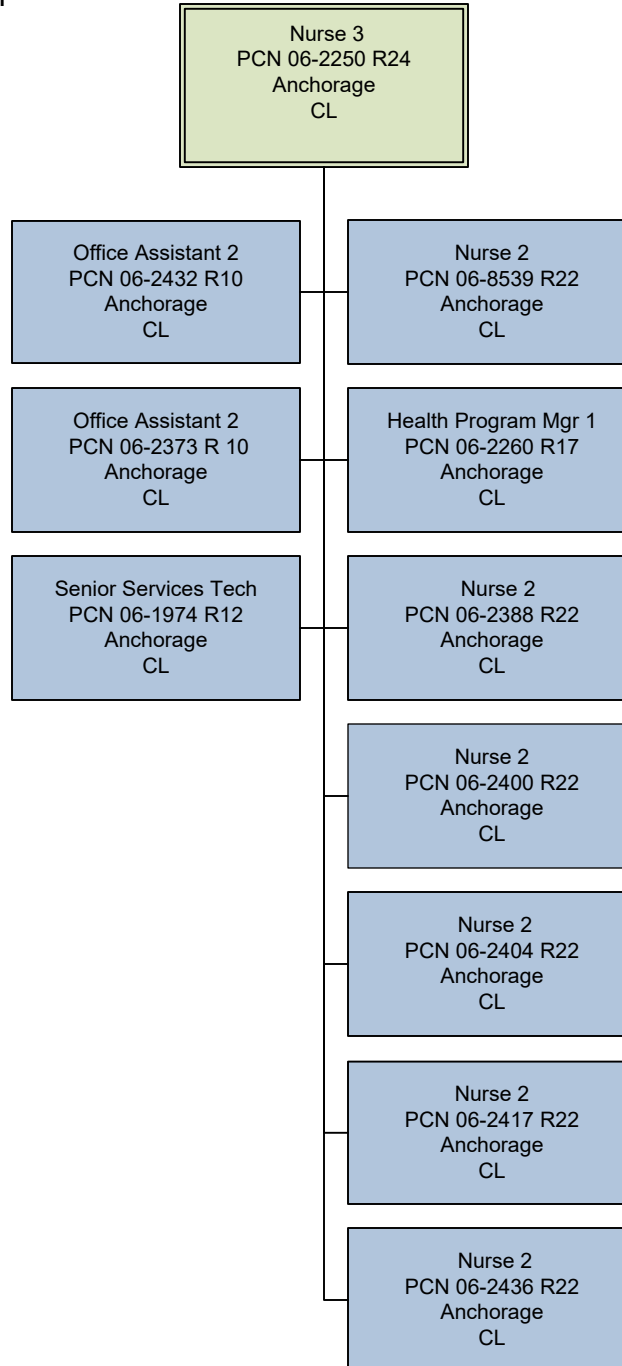

FY2024 Governor
Department of Health
Senior and Disabilities Services
Senior and Disabilities Services Administration
Project Management

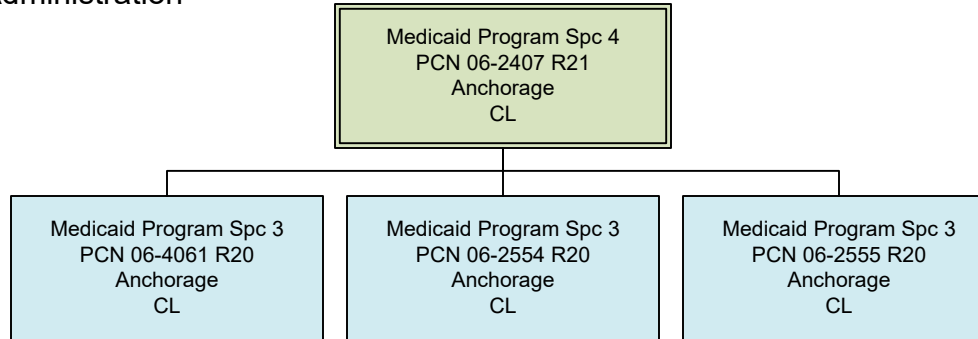

FY2024 Governor
 Department of Health
 Senior and Disabilities Services
 Senior and Disabilities Services Administration
 Administrative Support, Grants and
 Medicare Information Office

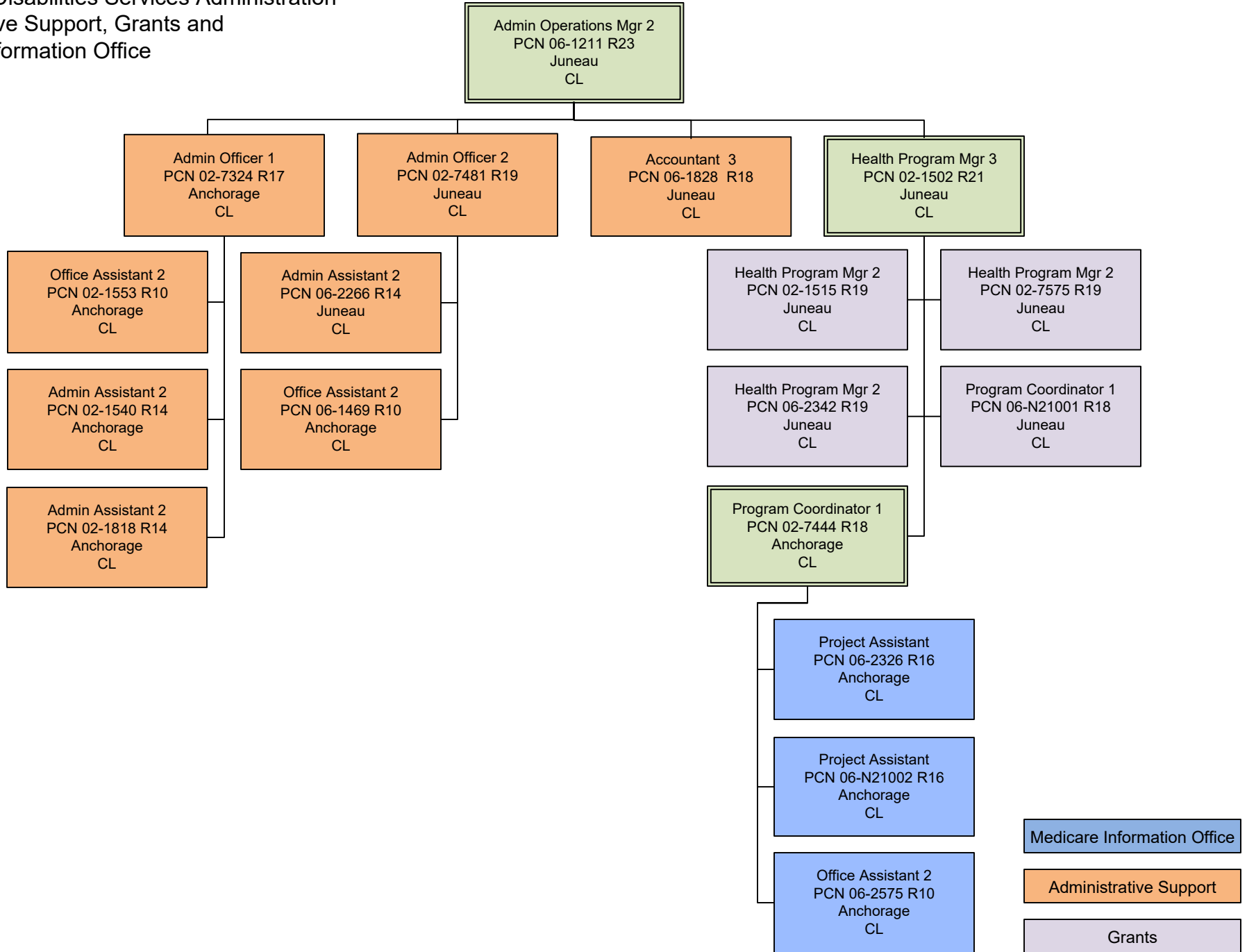

Medicare Information Office

Administrative Support

Grants

FY2024 Governor
Department of Health
Senior and Disabilities Services
Senior and Disabilities Services Administration
Policy and Program Development

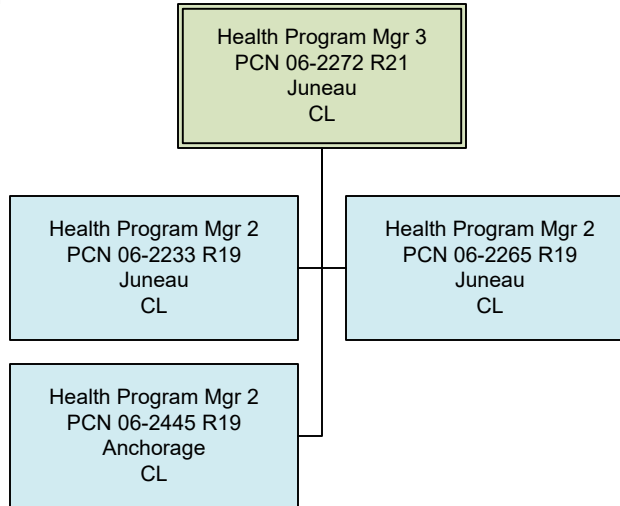

FY2024 Governor
Department of Health
Senior and Disabilities Services
Senior and Disabilities Services Administration
Training

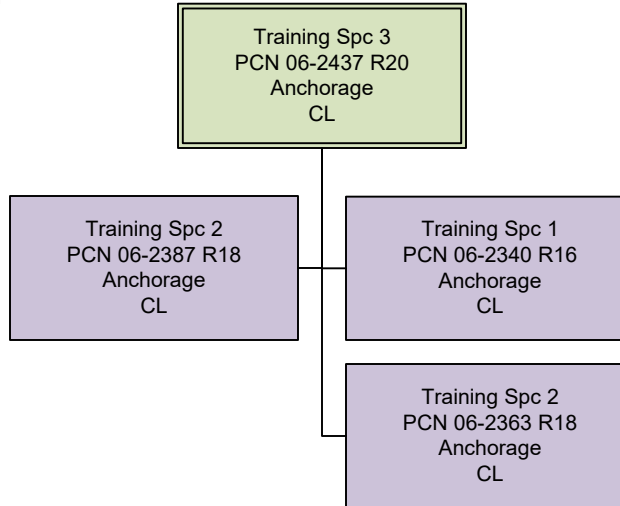

FY2024 Governor
 Department of Health
 Senior and Disabilities Services
 Senior and Disabilities Services Administration
 Assessment

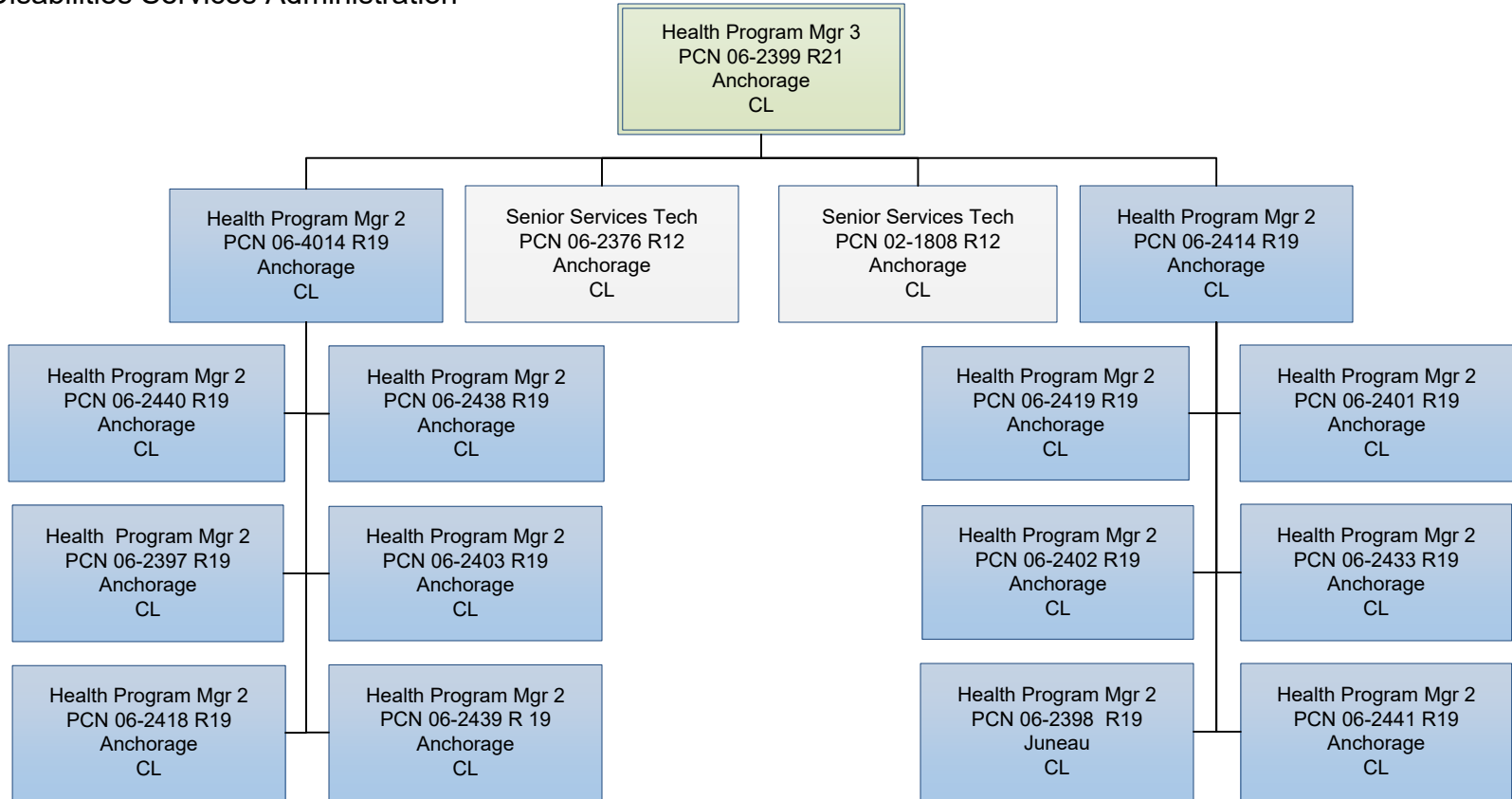

Assessors

Support

FY2024 Governor
 Department of Health
 Senior and Disabilities Services
 Senior and Disabilities Services Administration
 Review

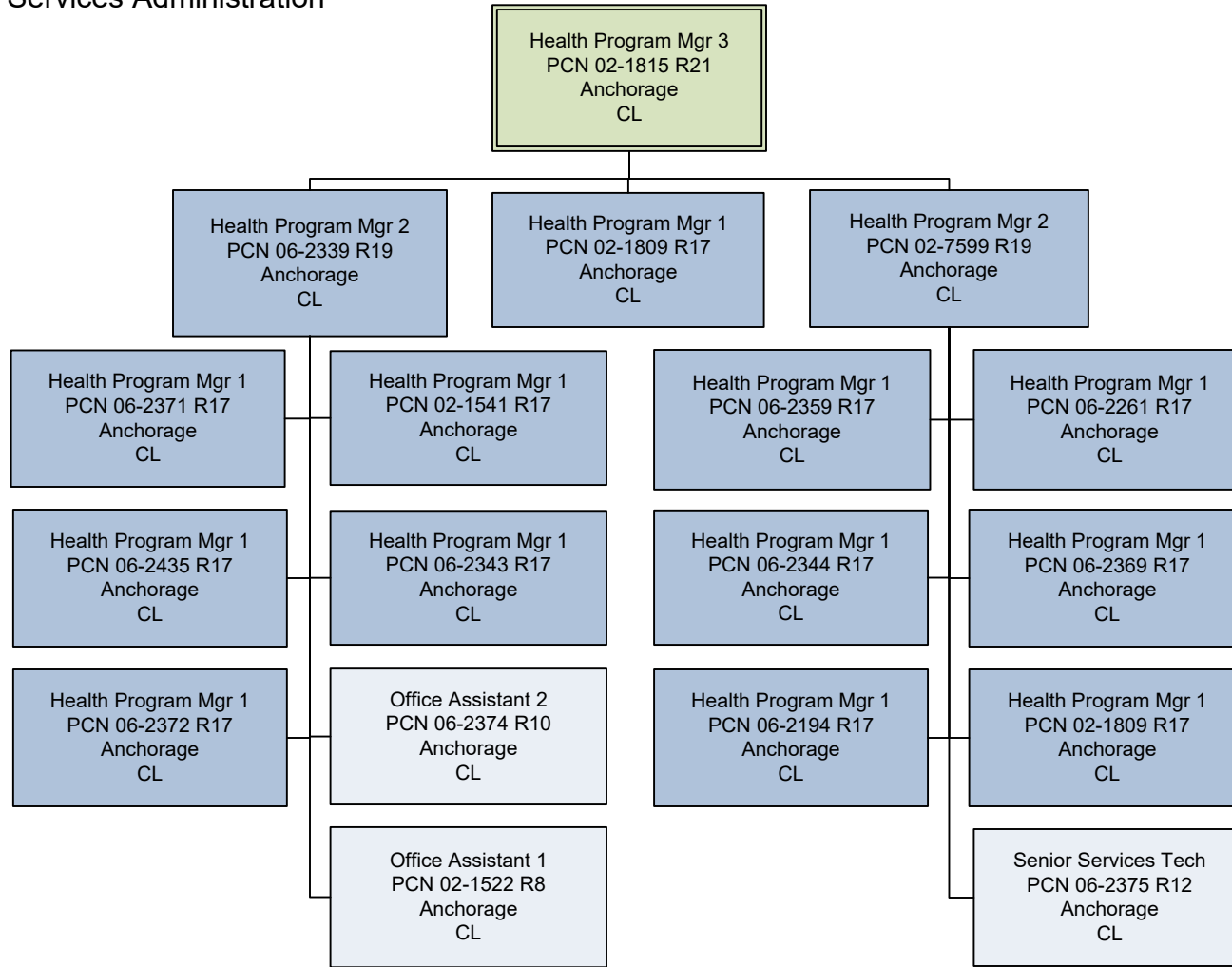

FY2024 Governor
 Department of Health
 Senior and Disabilities Services
 Senior and Disabilities Services Administration
 Intellectual & Developmental Disabilities Waiver

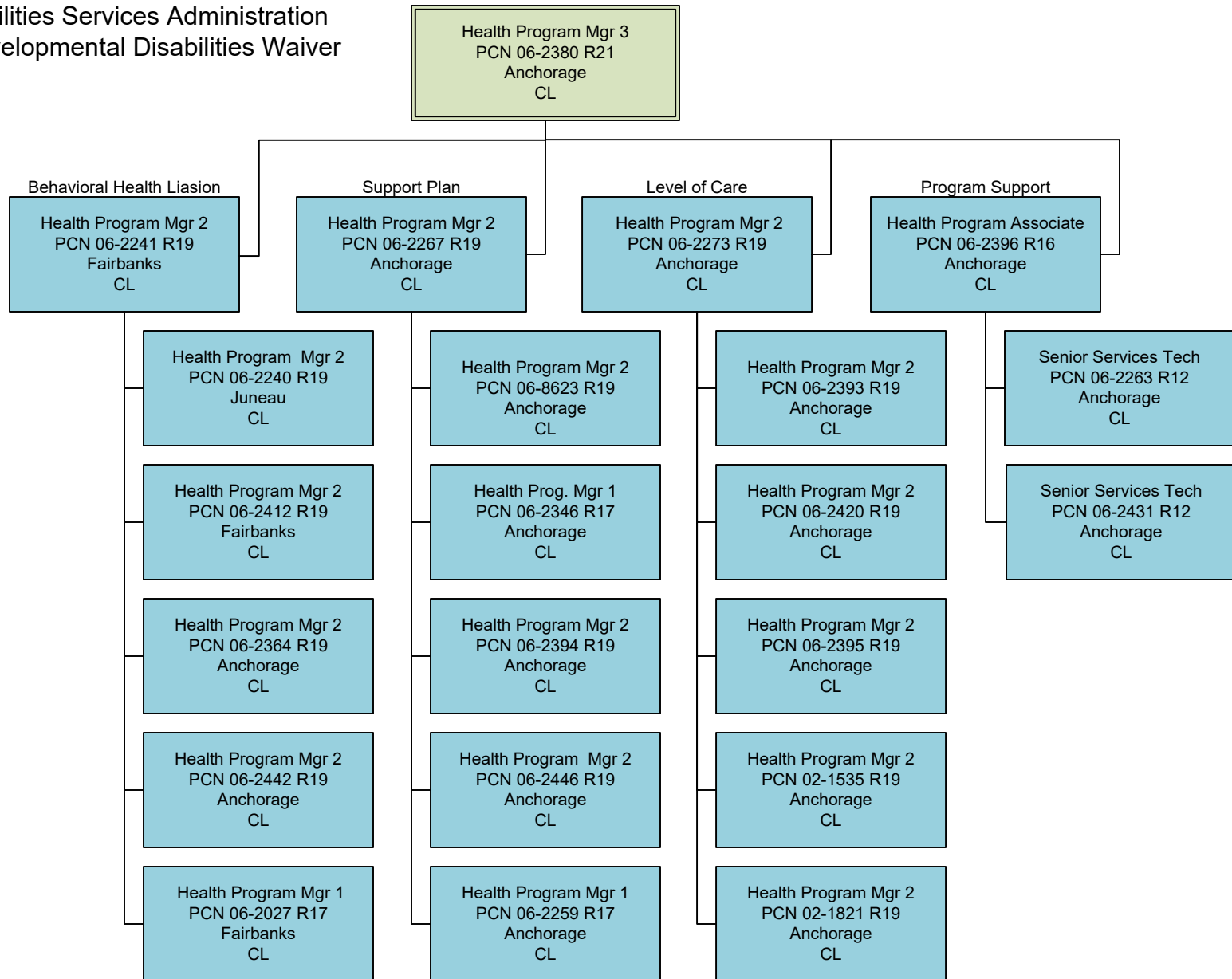

FY2024 Governor
Department of Health
Senior and Disabilities Services
Senior and Disabilities Services Administration
Early Intervention/Infant Learning Programs

